

2022-2023

# Azenta Life Sciences Sample Consumables and Instruments Catalog

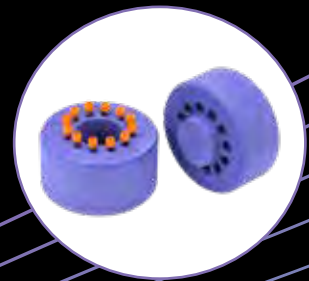

**AZENTA**  
LIFE SCIENCES

[azenta.com](https://azenta.com)

# Introduction

## Unrivaled Sample Solutions to Accelerate Discovery, Development, and Delivery

Azenta Life Sciences provides unrivaled sample exploration and management solutions to help our customers accelerate discovery, development, and delivery to bring impactful breakthroughs and therapies to market faster. We are the global leader in automated compound management for drug discovery, biological storage, and sample processing solutions. Azenta understands the importance of sample integrity and provides a comprehensive range of solutions across our leading capabilities of genomic services, sample repository services (SRS), consumables and instruments, data management and informatics, sample sourcing, and automated ultra-cold storage.

## Offer Categories

### Genomics & Analytical Services

#### Sequencing

- Next Generation Sequencing
- Sanger Sequencing
- PCR + Sanger Services

#### DNA & RNA Synthesis

- Gene Synthesis
- Oligo Synthesis
- Gene-to-Virus Services
- Plasmid DNA Preparation

#### Other Services

- Gene Editing
- Biofluid Processing



### Sample Sourcing

Custom biospecimen procurement for developing and validating therapies and diagnostic devices

### Data & Informatics

Powerful software tools for sample and product lifecycle management

### Consultative Services

Expert guidance and planning for genomics, cold-chain logistics, automated storage, and clinical trial management

### Storage, Automation & Logistics

#### Automated Storage Systems

- Ambient to -20°C
- -80°C
- -190°C Cryogenic

#### Clinical Trial Management

- Study Initiation
- Sample Preparation & Lab Services
- Short- & Long-Term Sample Storage
- Sample Support Services

#### Drug Products & Therapies

- Ultra-Cold Storage
- Cold-Chain Logistics
- Inventory Management

#### Transportation

- Biological Transport
- Laboratory Moving

### Consumables & Instruments

#### Sample Tube Solutions

- Tri- and Dual-Coded Sample Tubes
- Barcode Reading Systems
- Tube Capping & Sealing Systems
- Tube Management Systems

#### PCR & Microplate Solutions

- PCR Plates, Strips & Individual Tubes
- Assay Microplates
- Adhesive & Heat Seals
- Automated Sealing Instrumentation

#### Sample Cooling And Heating

- Ice-Free Cooling Workstations
- Thermoconductive Tube Racks
- Alcohol Free Cell Freezing Containers

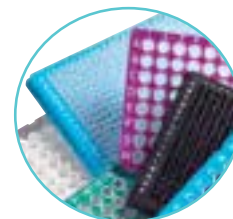
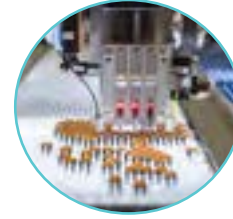

# Accelerate Discovery, Development & Delivery

## Research & Development

Expedite target identification, hit discovery, and lead optimization with comprehensive solutions for genomics research and high-throughput screening.



## Pre-Clinical & Clinical

Streamline sample management and exploration in regulated environments with state-of-the-art automation and unparalleled expertise.



## Manufacturing & Distribution

Store and deploy therapies with the utmost security, sophisticated informatics, and full compliance—from the industry leader in cold-chain logistics.



## Our Customers

**20 of 20**

Top pharma/biotech companies are served by Azena

**13 of 15**

Top pharma trust Azena with their samples

**Top 5**

Pharma products (by sales) have their clinical samples managed by Azena

**1 in 3**

US molecular biologists use Azena genomic services

**20,000**

Citations in scientific journals mention Azena and our brands

**33**

Nobel laureate labs use Azena



**AZENTA**  
LIFE SCIENCES

# Our History

## 2011-2012

- Brooks Life Sciences
- RTS
- Nexus

## 2013-2014

- Matrical
- 22% of BioCision

## 2015-2016

- FluidX
- BioStorage Technologies

## 2017-2018

- BioCision
- PBMMI
- FreezerPro
- 4titude Ltd.
- BioSpeciMan

## 2019-2020

- GENEWIZ
- RURO
- Trans-Hit Biomarkers

## 2021-2022

- Azenta Life Sciences Launch

## 2022

- Ziath
- Barkey
- B Medical

## 10 Years of Building Out a Leading-Edge Life Science Company

Since expanding into life sciences in 2011, we have dedicated ourselves to supporting our customers' ambitions. But with advancements in biotech, genomics, and AI, and a rapidly changing landscape, we saw an opportunity to do more.

To help our customers achieve their goals with greater agility and insight, to bring more breakthroughs and therapies to market—sooner. To do so, we brought together leading capabilities across genomics, cryogenic storage, automation, and informatics.

## Our Global Reach

Azenta Life Sciences is the global leader in automated compound management for drug discovery, biological storage, and sample processing solutions with 30 locations in seven countries.



# Contents

## Sample Tube Consumables and Instruments

### Introduction

Guide to Azenta Sample Tubes .....	10
Glossary of Terms .....	10
Introduction .....	11
Sample Storage Consumables and Devices .....	12-15
Anatomy of a Tube .....	16-19
Customization Options .....	20
1. Sample Storage Tube Range .....	21
Tube Range Table .....	22-23
Introduction to External Thread Tri-Coded Tubes .....	24
Introduction to Internal Thread Tri-Coded Tubes .....	25

### Consumables

2. Tri-Coded Sample Storage Tubes .....	27
0.5ml external thread .....	29
0.8ml external thread .....	30
1.0ml external thread .....	31
1.5ml external thread .....	32
1.9ml external thread .....	33
3.8ml external thread .....	34
7.6ml external thread .....	35
0.48ml internal thread .....	36
0.65ml internal thread .....	37
0.9ml internal thread .....	38
3. Dual-Coded Sample Storage Tubes .....	39
0.26ml external thread .....	42
0.3ml internal thread .....	43
0.7ml internal thread .....	44
0.9ml internal thread .....	45
0.5ml external thread .....	46
0.9ml external thread .....	47
4. 2D-Coded Sample Storage Tubes .....	49
Acoustic Sample Tube Echo® Qualified Consumable .....	52
Tissue Tube .....	53-54
0.2ml external thread .....	55
5. Non-Coded Sample Storage Tubes .....	57
Non-Coded Tubes .....	59-60

6. Capping and Sealing Options .....	61
Tube Screw caps .....	63-65
TPE septum caps .....	66
SBS cap carriers .....	67
7. Treatment Services .....	69
Treatment Services .....	71-72
8. Recommended Temperature Range for Sample Storage Tubes .....	73
Recommended Temperature Range for Sample Storage Tubes .....	75
How Safe Are Your Samples?: Leachables, Working Volume and Pressure Testing .....	76

### Instruments

9. Tube and Rack Code Reading Systems .....	77
Single Tube Reader .....	78-79
Scanner-Based Reader .....	80-81
Camera-Based Full Rack Readers .....	82-83
Camera-Based Reader for SBS Racks .....	84
Camera Based Reader for Acoustic Tubes .....	85
Camera-Based Reader for SBS Racks and Cryo Boxes .....	86
Decoding Software .....	87
10. Sample Tube Capping & Sealing Systems .....	89
Semi-Automated Screw Cap Single Tube Decapper/Recapper .....	91-92
Semi-Automated Handheld Screw Cap Decapper, 8-channel .....	93
Semi-Automated Screw Cap Decapper/Recapper, Single Channel .....	94-95
IntelliXcap™ Automated Screw Cap Decapper/Recappers .....	96-97
Semi-Automated Septum Cap Capper .....	98
11. Sample Tube Management Systems .....	99
Manual Tube Pickers and Manual Decappers .....	101
Automated Tube Labeling System .....	102-103
Direct Tube Marker .....	104-105
Tube Auditor™ .....	106
FreezerPro® .....	107
Automated Sample Storage Ambient to -190°C .....	108-109
CryoPod Carrier .....	110

# PCR/Microplate Consumables and Instruments

Manufacturing and Quality Standards .....	115	Heat Sealing Consumables Compatibility Table .....	234-235
PCR Plates: Clear, Frosted or White		Thermosensitive Colour Forming Film .....	237-239
Wells & Low DNA Binding Properties .....	117-120	Automated Roll Heat Sealers .....	241
FrameStar® 2-Component PCR Plates .....	121-140	Automated Roll Heat Sealer .....	242-243
FrameStar Breakable Plates .....	141-146	Automated Individual Access Heat Sealer .....	244
Individual Access 96 Well PCR Plates .....	147-155	Semi-Automated Sheet Heat Sealer .....	245-247
8 Well PCR Tube Strip with PC Frame .....	157-161	Automated Plate Seal Remover .....	249-251
96 Well PCR Plates with 8 Well Removeable Tube Strips .....	163-166	Adhesive Sealing Consumables & Accessories .....	253-269
Standard PCR Plates, Strips & Tubes .....	167-181	Adhesive Sealing Consumables Comparison Table .....	270-271
96 Well Non-Skirted PCR Plate		Plate Lids, Caps & Mats .....	272-280
Horizontally or Vertically Breakable .....	183-186	Custom Capabilities .....	281
Instrument Compatibility Table .....	187-191	Custom Capabilities for OEM Diagnostic Kit and	
Storage Microplates .....	193-202	Medical Device Manufacturing .....	282
Assay Microplates .....	203-212	Customizable PCR Plates, Microplates and Seals .....	283
Heat Sealing Consumables .....	213-233		

# Sample Cooling and Heating

Sample Cooling and Heating Standardization .....	286	Accessories .....	313
Alcohol-Free Cell Freezing Containers .....	287-293	Ice Pans .....	314
Ice-Free Cooling Workstations .....	295-302	Hinged CryoBoxes .....	315
Thermoconductive Tube Racks .....	303-308	Thermoconductive Tube Module Temperature Strip .....	316
Thermoconductive Sinks and Trays .....	309-312	Thermoconductive Tube Module Sleeves .....	316
		Cryo Tube Grippers .....	316
		Cryo Tube Locking Racks .....	316
		1D-coded Cryo Tubes .....	317
		Cryo Tubes Cap Inserts .....	317

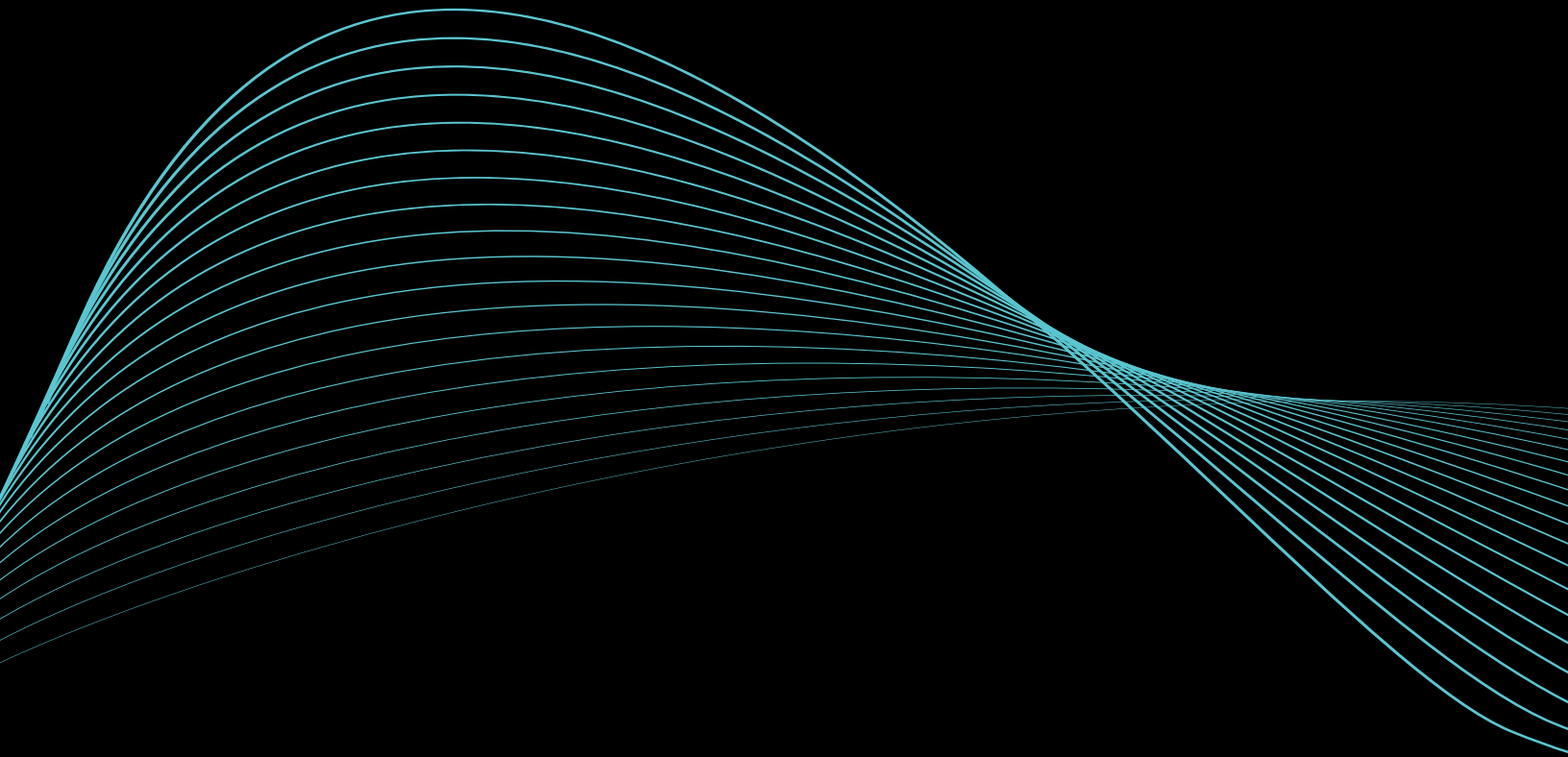

**AZENTA**  
LIFE SCIENCES

# Sample Tube Consumables and Instruments







# Guide to Azena Sample Tubes



### Tri-coded Tubes

Each tube features a permanent 2D-code laser etched in high-contrast on the tube base, a permanent 1D (linear barcode) and Human-Readable Number laser etched in high-contrast on the tube side.

The tube is manufactured using an advanced manufacturing process which results in a one-piece tube with a clear window and black side for coding. All three codes are identical and auditing processes guarantee all three codes match. Our standard 2D option is black on white.

### Dual-coded Tubes

Each tube features a permanent 2D-code and Human Readable Number laser etched in high-contrast on the tube base or tube side.

The Dual-coded tube is manufactured using an advanced manufacturing technique used to integrate 2 resin colors into the same tube for high resolution coding.

Both codes are identical and auditing processes guarantee both codes match.

Our standard 2D option is white on black.

### 2D-coded Tubes

2D-code laser etched on the base only. Allows users to add additional information or a second identifier in high-contrast to the tube side. Our standard 2D option is black on white.

### Non-coded Tubes

Simply come as they are.

### 2D Datamatrix code

A 2D code made of black and white cells, for Azenta tubes these are arranged in a square. The L-shape found on the border is its finder pattern, which is used by tube readers and scanners to recognize and read the code.

### 1D-code / Linear barcode

Unique barcode represented by parallel lines of different widths and spacings printed on the side of a tube, SBS rack or CryoBox. Our standard code is code 128. Code 128 is able to encode alpha-numeric data.

### 2D-coded

2D Datamatrix code on tube base.

### 2D4-coded

Quad Code on Acoustic Sample Tube base.

### Dual-coded

2D code and Human Readable Number on tube base or tube side.

### Tri-coded

2D-code on tube base, 1D (linear barcode) and Human-Readable Number on tube side.

### External Thread

Thread is on the outside of the tube so there is no loss in working volume when a cap is added, saving valuable freezer space. Azenta external thread caps feature a double start thread. The thread is fully engaged after a maximum rotation of 180°, making the cap easier to use especially in automated environments.

### Internal Thread

Thread is on the inside of the tube.

### Working Volume

The maximum sample volume that will still allow space between the sample and underside of the cap for ice expansion during freezing.

### Fill Volume

The total capacity of the tube at 21°C.

## Introduction

---

### All About the Sample!

As a global leader in innovative sample management solutions Azenta Life Sciences is all about the sample.

Working across a wide range of industries Azenta Life Sciences offers unparalleled knowledge and experience of 2D-coded sample storage tubes, readers and sample management systems. As part of the team that developed the original 2D-coded sample tubes in 1999, we have been at the global forefront of developing sample storage consumables and instruments for nearly 20 years and we continue our philosophy of innovation to this day.

In addition to the innovation behind our products, we are committed to providing the highest levels of customer service, support and quality. Our Technical Support Team provides expert assistance, making sure our products give the reliable and optimal performance you expect.

We believe that a quality sample is the cornerstone in the generation of reliable, reproducible and quantifiable data – which is why Azenta Life Sciences is all about the sample.



# Sample Storage Consumables and Devices



Azena tubes are available in a range of formats, including racked, bulk, capped and uncapped. Our robust code management system ensures each and every code is permanently affixed, unique and never duplicated. Tubes are suitable for applications ranging from +121°C to -196°C.

All Azena tubes are developed with broad compatibility in mind, performing without compromise in conjunction with automated code reading, capping and sample management systems from Azena and all other industry-recognized manufacturers.

## Key Features

Our coding systems are designed to deliver the highest levels of sample security and labeling flexibility. We offer tubes with a choice of code, either 2D-code, 1D (linear barcode) or Human Readable Number (HRN). Our Tri-coded tubes have all three options whilst our Dual-coded tubes, can have a 2D-code and Human Readable Number on the tube base or side. A robust code management system ensures each and every code is unique and never duplicated, preventing any possibility of misidentification involving your samples. All Azena polypropylene sample storage tubes sealed with a screw cap are suitable for use in cryogenic storage conditions.



### Superior Datamatrix code quality:

Azena sample storage tubes are easy to read even in harsh conditions or when damaged. Our 2D-codes adhere fully to the ECC200 standard. All codes are generated using the latest and most sophisticated error correction methods and high quality, permanent laser etching provides sharp detail.

Every tube is quality checked to ensure they meet our exacting standards for readability.



**Excellent Sealing:** Tubes work equally well with either TPE septum or screw caps. A double start thread engages in a maximum rotation of 180°, facilitating automation.

### Automation Friendly:

Screw capped tubes are compatible with our range of cappers and de-cappers, including our IntelliXcap range. Available in 24, 48, and 96 format to automatically remove and re-cap a complete rack of tubes. The TwistLock feature prevents the tubes rotating in the rack during capping and de-capping.

**Ideal for Cold Storage:** Temperature range from -196°C (with screw cap) to 121°C. All our polypropylene tubes are suitable for cryogenic storage, but not for submersion in liquid phase nitrogen.

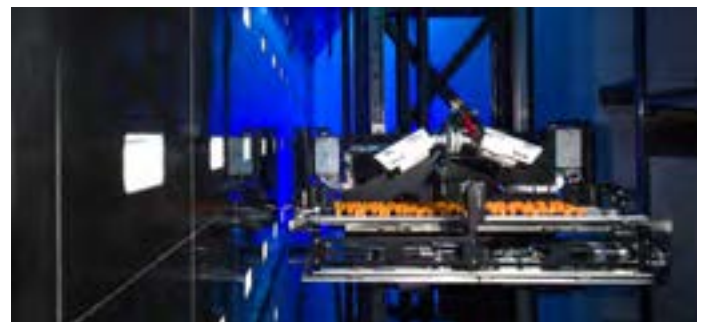

 Integration Friendly



**AZENTA**  
LIFE SCIENCES

### Choice of Coding Options

#### Tri-coded:

Each tube features a permanent 2D-code laser etched in high-contrast on the tube base, a permanent 1D (linear barcode) and Human-Readable Number laser etched in high-contrast on the tube side.

Each tube is manufactured using an advanced process which results in a one-piece tube with a clear window and black side for coding. All three codes are identical and auditing processes guarantee all three codes match. Our standard 2D option is black on white.

#### Dual-coded:

Each tube features a permanent 2D-code and Human-Readable Number laser etched in high-contrast on the tube base or side.

The Dual-coded tube is created using an advanced manufacturing technique used to integrate 2 resin colors into the same tube for high resolution coding.

Both codes are identical and auditing processes guarantee both codes match.

Our standard 2D option is white on black.

**Non-coded** – simply come as they are.

**2D Datamatrix code** – a 2D code made of black and white cells, for Azenta tubes these are arranged in a square. The L-shape found on the border is its finder pattern, which is used by tube readers and scanners to recognize and read the code.

**1D-coded / Linear barcode** – unique barcode represented by parallel lines of different widths and spacings printed on the side of a tube, SBS rack or CryoBox. Our standard code is code 128. Code 128 is able to encode alpha-numeric data.

**2D-coded** – 2D-code on tube base.

**Dual-coded** – 2D-code and Human-Readable Number on tube base or side.

**Tri-coded** – 2D-code on tube base, 1D (linear barcode) and Human-Readable Number on tube side.



*Dual-Coded  
(white on black)*

*2D-Coded  
(black on white)*



*Unique 2D4 Code allows code reading without interfering with Acoustic dispensing window*



*2D coded rack base allows automatic detection of orientation by instrumentation*

## SBS Storage Racks

### SBS Storage Rack Options

Azenta tubes are compatible with industry standard SBS sized racks in either: 24, 48, 96, 240 or 384 format. Dependent upon tube type, the following rack options are available.

#### TwistLock:

Prevents tubes rotating within the rack to enable automated capping and de-capping of screw caps. TwistLock is provided as standard with the option available to remove.

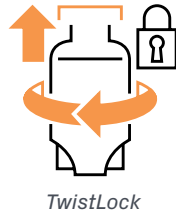

#### TubeLock:

Tubes can be locked into the rack to prevent falling out, even when there is no lid present. Tubes can be placed in either locked or unlocked positions. TubeLock is used in manual workflows and is activated by applying pressure to the tube top, clicking the tube into place. Racked tubes can be ordered either pre-locked or non-locked.

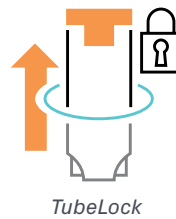

#### LidLock:

Racks fitted with a LidLock latch are designed to withstand a 1m drop for added sample security.

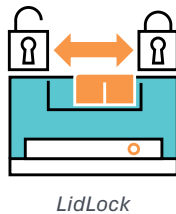

#### Automatic Rack Orientation:

Racks can be supplied with a unique 2D-code identifier which can be read at the same time as the tube 2D-code. This provides automatic rack orientation and more secure sample tracking.

#### Direct Laser Etching:

A cutout window on the rack sides allow the linear barcode to be read more easily; linear barcodes can be laser etched directly onto racks.



### Cryo Racks

In addition to industry standard SBS racks, a range of tube and application specific cryo racks are available. Each cryo rack incorporates:

- Open bottom for 2D-code decoding on camera-based readers
- Direct laser etched 1D linear barcode and Human-Readable Number on rack side and 2D rack ID on base of rack.

#### 9 x 9 Cryo Storage Racks

- 136.2mm x 136.2mm polycarbonate cryo rack option for cryogenic sample storage
- Holds 81 tubes in 9 x 9 array



9 x 9 Rack

#### 10 x 10 Cryo Storage Racks

- 136.2mm x 136.2mm polycarbonate cryo rack option for cryogenic sample storage
- Holds 100 tubes in 10 x 10 array



10 x 10 Rack

#### 14 x 14 Cryo Storage Racks

- 136.2mm x 136.2mm polycarbonate cryobox rack option for cryogenic sample storage
- Holds 196 tubes in 14 x 14 array



14 x 14 Rack

### Ordering Information

66-1801	Cryo Rack 9x9, black, polycarbonate, 10 racks per case, suitable for 1.5ml and 1.9ml External Thread Tubes
66-1802	Cryo Rack 9x9, black, polycarbonate, 10 racks per case, suitable for Taller Cryo Tubes
66-1800	Cryo Rack 10x10, black, polycarbonate, 10 racks per case, suitable for 1.9ml External Thread Tubes
66-1803	Cryo Rack 10x10, black, polycarbonate, 10 racks per case, suitable for Taller Cryo Tubes
66-0196-01	Cryo Rack 14x14, black, polycarbonate, 10 racks per case, suitable for 0.3ml and 0.48ml Internal Thread Tubes and 0.5ml External Thread Tubes
66-0196-02	Cryo Rack 14x14, black, polycarbonate, 10 racks per case, suitable for 0.8ml External Thread Tubes
66-0196-03	Cryo Rack 14x14, black, polycarbonate, 10 racks per case, suitable for 1.0ml External Thread Tubes

#### WARNING

Do not store tubes in liquid phase nitrogen  
 Ingress of nitrogen into the tube can occur causing the tube to rupture when taken out of storage  
 May cause injury and loss of tube contents.



# Anatomy of a Tube – Internal Thread, Dual-Coded

96-format, Internal Thread, Dual-coded tubes have a range of features that are only possible with advanced manufacturing techniques. Co-molded caps offer a far superior seal over traditional O-ring caps, which can 'pop' when a sample is frozen or the cap is overtightened.

## Internal Threaded Cap:

- Automation friendly
- Co-molding prevents o-ring 'popping'
- Our most secure internal threaded cap



## High Quality Virgin Polypropylene:

- No detectable leachables or extractables
- Manufactured in ISO Class 8 clean-room environment
- Endotoxin, DNase/RNase, heavy metals & animal free

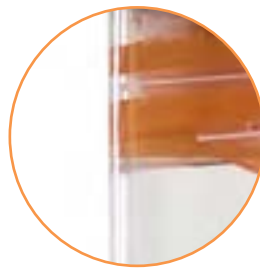

## Clear Window:

- Allows visual inspection
- Optional space to print direct due to high quality manufacturing



## Dual-coded:

- 2D-code and Human-Readable Number (HRN) on tube base
- Enables whole rack or single tube reading
- High contrast enabling reliable reading
- Permanent laser etching



# Anatomy of a Tube – External Thread, Tri-Coded

The External Thread Tri-coded tube offers our most secure seal. This highly secure design also offers significant benefits over internal thread caps including, a higher working volume.

## External Threaded Cap:

- Automation friendly
- Our most secure cap
- Enables greater working volume
- Designed to prevent over tightening

## High Quality Virgin Polypropylene:

- No detectable leachables or extractables
- Manufactured in ISO Class 8 clean-room environment
- Endotoxin, DNase/RNase, heavy metals & animal free

## Side Coding:

- Linear Barcode
- Human-Readable Number
- Permanent laser etching

## Clear Window:

- Allows visual inspection
- Optional space to print direct due to high quality manufacturing

## 2D-coded:

- Enables whole rack or single tube reading
- High contrast enabling reliable reading
- Permanent laser etching



# Anatomy of a Tube – External Thread, Dual-Coded

The Dual-Coded tube with external thread cap offers our most secure seal. This highly secure design also offers significant benefits over internal thread caps including, a higher working volume.

## External Threaded Cap:

- Automation friendly
- Our most secure cap
- Enables greater working volume
- Designed to prevent over tightening



## High Quality Virgin Polypropylene:

- No detectable leachables or extractables
- Manufactured in ISO Class 8 clean-room environment
- Endotoxin, DNase/RNase, heavy metals & animal free



## Clear Window:

- Allows visual inspection
- Optional space to print direct due to high quality manufacturing



## Dual-Coded:

- 2D-code and Human-Readable Number (HRN) on tube base
- Enables whole rack or single tube reading
- High contrast enabling reliable reading
- Permanent laser etching



# Anatomy of an Acoustic Sample Tube – Echo<sup>®</sup> Qualified Consumable

## Internal Threaded Cap:

- New internal co-molded design
- Increases capping and de-capping performance to over 500 cycles



## Optimized Geometry:

- Optimized tube geometry for Acoustic dispensing technology
- 70µl working volume

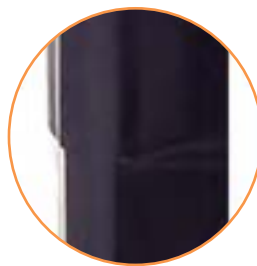

## High Quality Virgin Polypropylene:

- No detectable leachables or extractables
- Manufactured in ISO Class 8 clean-room environment
- Endotoxin, DNase/RNase, heavy metals & animal free



## 2D4 Coded:

- Unique 2D4 Code allows reading of the code without interfering with Acoustic dispensing window
- Linear barcoded rack with Tube Retention for sample handling with Acoustic Dispenser and traditional liquid handlers
- Permanent laser etching



# Customization Options

In addition to standard catalogue products the Azenta range can also be customized to provide tubes and racks ideally matched to your particular workflow. Available customization options are detailed below.

## Tube Coding

Custom prefixing with user defined two letter prefix followed by an 8 digit number sequence determined by Azenta. e.g. AB12345678.

Full custom coding with a user generated 10 digit alphanumerical sequence, e.g. ABC1234567.

Choice of Black on White or White on Black 2D Datamatrix coding.

## Rack Coding

Code 128 barcodes applied by Laser etching or labelling.

Barcode position selectable on any or multiple sides.

## Cap Colors

In addition to Orange, caps are available in a variety of user selectable colors.

96 format caps available in: Natural, Clear/Light Blue, Dark Blue, Green, Purple, Red, White, Yellow, Amber and Black.

48 format caps available in: Dark Blue, Green, Red & Yellow for externally threaded tubes and in Natural for Internally threaded tubes.

24 format caps (automation friendly) for externally threaded tubes available in Natural.

TPE Septum caps available in Dark Blue, Green, Red, and Yellow.

## Treatment Options

Gamma Irraditaion, Ethylene Oxide, Dual Ethylene Oxide, or Electron Beam treatment treatments are available.

## Special Options

Further options may be available depending upon product selection and details of requirements including custom product packaging and user definable tube/rack combinations.

Please note that for all custom products a minimum order quantity will be applied.











For further information on how to order please contact your local Azenta Life Sciences representative

# Azenta Sample Storage Tubes



							
24-format, 7.6ml External Thread, Tri-coded	48-format, 3.8ml External Thread, Tri-coded	24-format, 2.2ml Tissue External Thread, Dual-coded	48-format, 1.9ml External Thread, Tri-coded	48-format, 1.5ml External Thread, Tri-coded	96-format 1ml External Thread, Tri-coded	96-format 0.9ml External Thread, Dual-coded	96-format, 0.9ml Internal Thread, Tri-coded

Further details see Page:	35	34	54	33	32	31	45	38
Max Fill Volume 21°C (ml) Screw Cap	9.2	4.6	2.7	2.3	1.8	1.2	1.0	1.1
Max Working Volume (ml) Screw Cap Frozen	7.6	3.8	2.2	1.9	1.5	1.0	0.9	0.9
Max Working Volume (µl) Screw Cap	7660	3830	2250	1910	1500	1000	911	916
Max Working Volume (µl) Septum Cap	-	-	-	-	-	916	887	999
Tube Height (mm)	77.4	75	25.9	38.2	30.6	46.2	42.3	44.2
Tube Height with Cap (mm)	83.6	80.7	32.1	43.9	36.3	49.6	45.7	52.5
Tube Height with Septum Cap (mm)	-	-	-	-	-	47.4	43.5	45.4
Inner Diameter (mm)	13	9.6	13.1	9.6	9.6	6.5	6.5	6.8
Outer Diameter with Cap (mm)	17	12.8	17	12.8	12.6	8.7	8.7	8.6
Center to Center (mm)	18	13.5	18	13.5	13.5	9	9	9
Min Temperature °C Screw Cap	-196	-196	-196	-196	-196	-196	-196	-196
Min Temperature °C Septum Cap	-	-	-	-	-	-80	-80	-80
2D-coded	Base	Base	Base & Side	Base	Base	Base	Base	Base
Human Readable Number	Side	Side	Side	Side	Side	Side	Base	Side
Linear Barcode	Side	Side	-	Side	Side	Side	-	Side
<b>Product Codes</b>								
Bulk, Uncapped	65-9303	65-7516	68-4000-00	65-7640	65-7660	68-1003-00	68-1001-00	67-0757-00
Bulk, Capped	66-9302	65-7517	68-4000-31	65-7641	65-7661	68-1003-10	68-1001-10	67-0757-10
Racked, Uncapped	-	65-7514	-	65-7642	65-7662	68-1003-01	68-1001-01	67-0757-01
Racked, Capped	-	65-7515	68-4000-33	65-7643	65-7663	68-1003-11	68-1001-11	67-0757-11

										
96-format, 0.9ml Internal Thread, Dual-coded	96-format, 0.8ml External Thread, Tri-coded	96-Format 0.7ml Internal Thread, Dual-coded	96-format 0.65ml Internal Thread, Tri-coded	96-format, 0.5ml External Thread, Tri-coded	96-format, 0.5ml External Thread, Dual-coded	96-format, 0.48ml Internal Thread, Tri-coded	96-format, 0.3ml Internal Thread, Dual-coded	96-format, 0.2ml External Thread, 2D-coded	96-format, 0.26ml External Thread, Dual-coded	Acoustic Sample Tube, Echo® Qualified Consumable
45	30	44	37	29	46	36	43	55	42	52
1.1	0.96	0.88	0.80	0.66	0.66	0.58	0.40	0.24	0.31	0.15
0.9	0.8	0.7	0.65	0.5	0.5	0.48	0.3	0.2	0.26	0.07
929	800	731	666	552	550	482	336	204	261	70
1018	-	821	749	525	525	572	425	-	238	-
43.5	36.9	36.2	36.8	26.4	26.4	26.4	21	24.1	15.2	13.4
51.8	40.3	44.5	45.1	29.8	29.8	34.7	29.3	27.5	18.6	14.7
44.7	-	37.4	38	27.6	27.6	27.6	22.1	-	16.4	
6.8	6.5	6.8	6.8	6.5	6.5	6.8	6.8	3.9	6.5	6.5
8.6	8.7	8.6	8.6	8.7	8.5	8.3	8.7	5.8	8.7	7.6
9	9	9	9	9	9	9	9	9 (96)	6 (240)	9
-196	-196	-196	-196	-196	-196	-196	-196	-196	-196	-80
-80	-	-80	-80	-80	-80	-80	-80	-	-80	-
Base	Base	Base	Base	Base	Base	Base	Base	Base	Base & Side	2D4 Quad Code
Base	Side	Base	Side	Side	Base	Side	Base	-	Side	-
-	Side	-	Side	Side	-	Side	-	-	-	-
66-62345	68-0801-00	66-62318	67-0755-00	68-0703-00	68-0701-00	67-0753-00	66-62326	67-0203-01	68-0303-00	-
66-62345-Y6	68-0801-10	66-62318-Y6	67-0755-10	68-0703-10	68-0701-10	67-0753-10	66-62326-Y6	67-0203-10	68-0303-10	-
66-62330	68-0801-01	66-62319	67-0755-01	68-0703-02	68-0701-02	67-0753-02	66-62325	67-0203-02	68-0303-01	-
66-62330-Y6	68-0801-11	66-62319-Y6	67-0755-11	68-0703-12	68-0701-12	67-0753-12	66-62325-Y6	67-0203-11	68-0303-11	69-0200-11





# Introduction to External Thread Tri-Coded Tubes

## Overview

External Thread Tri-coded tubes have been developed to exceed the demands of sample security, management and tracking in modern high-density storage applications. Each tube features a permanent 2D-code laser etched in high-contrast on the tube base, a permanent 1D (linear barcode) and Human-Readable Number laser etched in high-contrast on the tube side. The tube is manufactured using an advanced process which results in a one-piece jacket tube, therefore, you never lose the code. All three codes are identical and auditing processes guarantee all three codes match. Our standard 2D coding option for these tubes is black on white.

The tubes provide a lifelong and secure chain of custody for samples in biobanks, compound libraries and a broad range of biological and chemical stores, including cryogenic storage.

Designed and developed with broad compatibility in mind, the tubes perform without compromise in conjunction with automated barcode reading, capping and sample management systems from Azenta and all other industry-recognized manufacturers.

## Key Features

- Permanently laser etched, 2D-code on base, 1D (linear barcode) and Human-Readable Number on the side
- Tri-coded tubes offer unequalled sample audit traceability, enabling sample tracking and data sharing between multiple users, labs, locations and automation capabilities
- 100% Quality Control, each tube is tested to ensure both readability and uniqueness
- Manufactured using an advanced process which results in a one-piece jacket tube from high-quality virgin polypropylene
- External thread tubes provide greater working volume than internal thread tubes
- Suitable for cryogenic storage as low as  $-196^{\circ}\text{C}^*$
- Secure sample storage and tracking
- Available bulk uncapped or capped
- Available pre-racked and capped in 96, 48 and 24 well format SBS racks
- 2D-codes readable without removing tubes from racks
- Suitable for sealing with either screw caps or TPE septum caps

*\*not for use in liquid phase Nitrogen*



*External Thread  
Tri-coded tube*

## Capping options

### Screw Caps

- A deforming compression seal more effective than a silicone alternative
- A non-silicone seal means the cap can never be over-tightened
- Caps and tubes are manufactured from the same material, preventing differential expansion during freeze-thaw cycles
- A double-start thread engages in a maximum rotation of  $180^{\circ}$ , thereby facilitating automation

# Introduction to Internal Thread Tri-Coded Tubes

## Overview

Internal Thread Tri-coded tubes have been developed to exceed the demands of sample security, management and tracking in modern high-density storage applications and comply with ISBER standards. Each tube features a permanent 2D-code laser etched in high-contrast on the tube base, a permanent 1D (linear barcode) and Human-Readable Number laser etched in high-contrast on the tube side. The tube is manufactured using an advanced process which results in a one-piece jacket tube, therefore, you never lose the code. All three codes are identical and auditing processes guarantee all three codes match. Our standard 2D coding option for these tubes is black on white.

The tubes provide a lifelong and secure chain of custody for samples in biobanks, compound libraries and a broad range of biological and chemical stores, including cryogenic storage.

Designed and developed with broad compatibility in mind, the tubes perform without compromise in conjunction with automated barcode reading, capping and sample management systems from Azenta and all other industry-recognized manufacturers.

## Key Features

### Secure Sample Storage and Tracking

- Permanently laser etched, 2D-code on base, 1D (linear barcode) and Human-Readable Number on the side
- Tri-coded offers unequalled sample audit traceability, enabling sample tracking and data sharing between multiple users, labs, locations and automation capabilities
- 100% Quality Control, each tube is tested to ensure both readability and uniqueness
- Manufactured using an advanced process which results in a one-piece jacket tube from high-quality virgin polypropylene
- Suitable for cryogenic storage as low as  $-196^{\circ}\text{C}^*$
- Secure sample storage and tracking
- Available bulk uncapped or capped
- Available pre-racked and capped in 96 well format SBS racks
- 2D-codes readable without removing tubes from racks
- Suitable for sealing with either screw caps or TPE septum caps

*\*not for use in liquid phase Nitrogen*



*Internal Thread  
Tri-coded tube*

### Capping options

#### Screw Caps

- Automation friendly co-molded screw caps for internal thread tubes eliminate the possibility of over tightening
- Co-molded caps eliminate the failures in caps using a silicone O-ring
- A double-start thread engages in a maximum rotation of  $180^{\circ}$ , thereby facilitating automation

#### TPE Septum Caps

- Cost-effective sealing option for samples that are only accessed occasionally
- Septum caps are supplied in 96-format back mats to facilitate automation



19145511



19028002

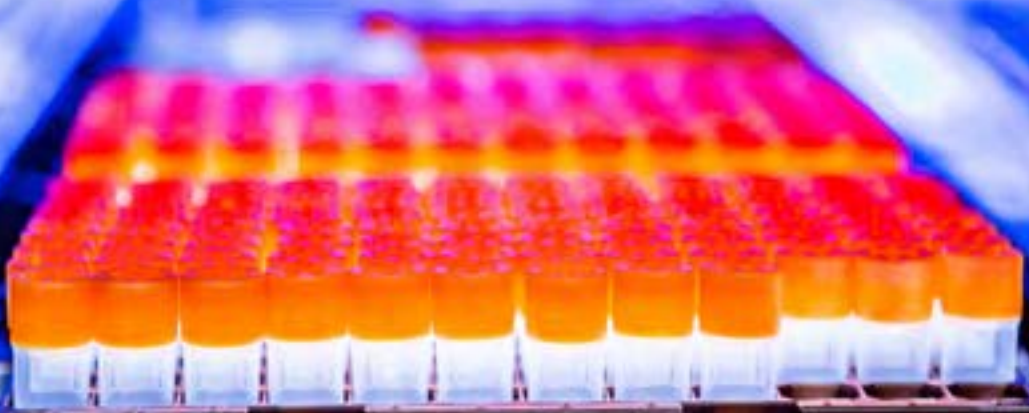

19145509

# Tri-Coded Sample Tubes



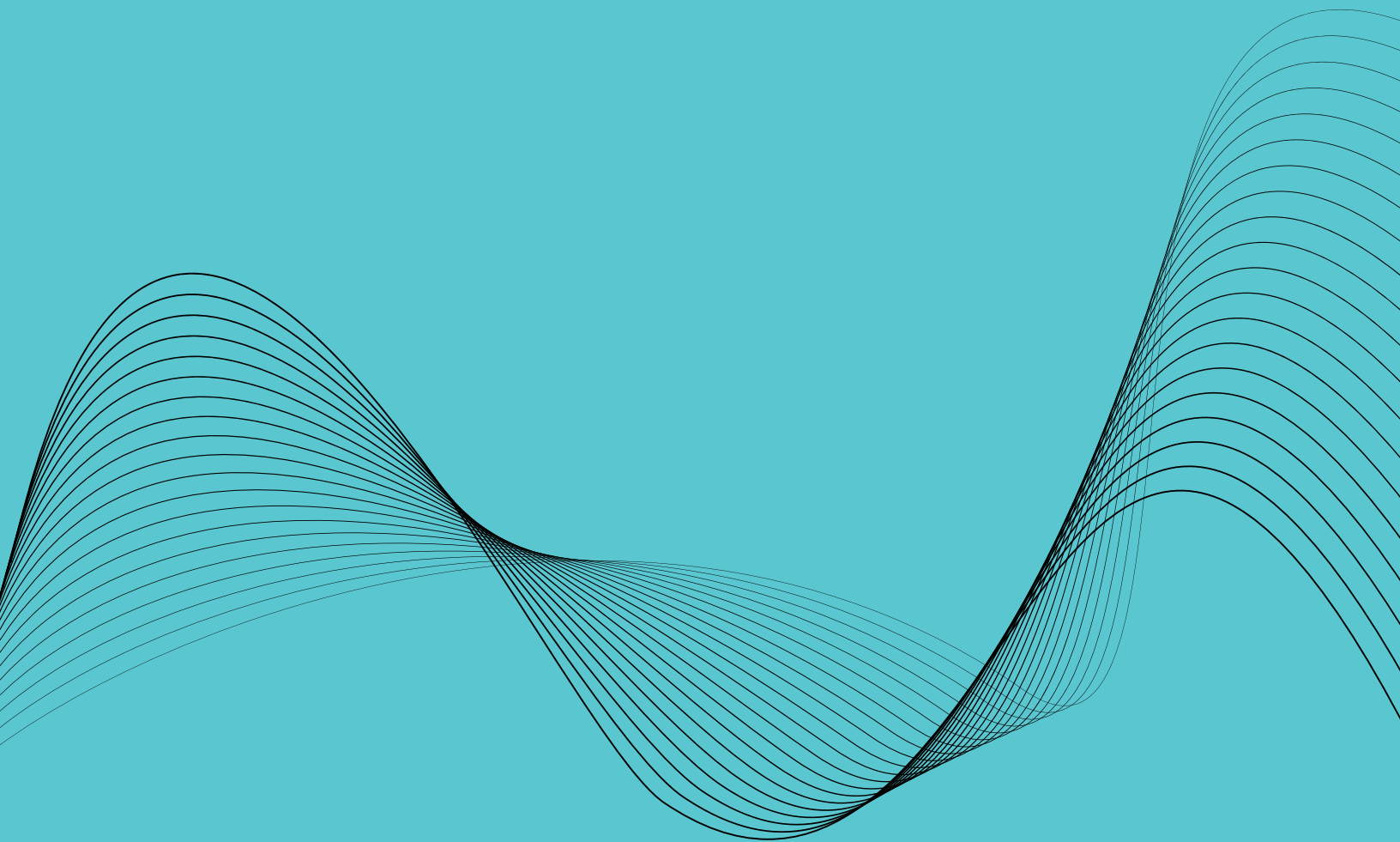

**AZENTA**  
LIFE SCIENCES

# 0.5ml Tri-coded Tube, 96-format, External Thread



- Supplied in 96-well format SBS racks or bulk
- Securely sealed using screw caps or TPE septum caps

	0.5ml screw cap	0.5ml TPE septum cap
		
	0.5ml Tri-coded Tube, 96-format, External Thread with screw cap	0.5ml Tri-coded Tube, 96-format, External Thread with TPE septum cap
Max Working Volume (ml)	0.52	0.50
Tube Height (mm)	26.4	26.4
Tube Height with Cap (mm)	29.8	27.6
Inner Diameter (mm)	6.5	6.5
Outer Diameter with Cap (mm)	8.7	8.7
Center to Center	9.0	9.0
Minimum Temperature (°C)	-196	-80
Tube Height in Rack (mm)	30.3	28.1
Overall Rack Height including lid (mm)	32.9	32.9

## Ordering Information



68-0703-00	0.5ml Tri-coded Tube, 96-format, External Thread, 2D Code on base, 1D Linear Barcode and Human Readable Number on side, uncapped, bulk, 960 tubes per case
68-0703-10	0.5ml Tri-coded Tube, 96-format, External Thread, 2D Code on base, 1D Linear Barcode and Human Readable Number on side, capped, bulk, 960 tubes per case
68-0703-02	0.5ml Tri-coded Tube, 96-format, External Thread, 2D Code on base, 1D Linear Barcode and Human Readable Number on side, uncapped, 10 racks per case, HighBase rack, empty rack part number: 66-51026
68-0703-11	0.5ml Tri-coded Tube, 96-format, External Thread, 2D Code on base, 1D Linear Barcode and Human Readable Number on side, capped, 10 racks per case, LowBase rack, empty rack part number: 66-51004
68-0703-12	0.5ml Tri-coded Tube, 96-format, External Thread, 2D Code on base, 1D Linear Barcode and Human Readable Number on side, capped, 10 racks per case, HighBase rack, empty rack part number: 66-51026
68-0704-00	0.5ml 2D-coded Tube, 96-format, External Thread, 2D Code on base, uncapped, bulk, 960 tubes per case
68-0704-10	0.5ml 2D-coded Tube, 96-format, External Thread, 2D Code on base, capped, bulk, 960 tubes per case
68-0704-02	0.5ml 2D-coded Tube, 96-format, External Thread, 2D Code on base, uncapped, 10 racks per case, HighBase rack, empty rack part number: 66-51026
68-0704-12	0.5ml 2D-coded Tube, 96-format, External Thread, 2D Code on base, capped, 10 racks per case, HighBase rack, empty rack part number: 66-51026



# 0.8ml Tri-coded Tube, 96-format, External Thread



- Supplied in 96-well format SBS racks or bulk
- Securely sealed using screw caps or TPE septum caps

	0.8ml screw cap	0.8ml TPE septum cap
		
	0.8ml Tri-coded Tube, 96-format, External Thread with screw cap	0.8ml Tri-coded Tube, 96-format, External Thread with TPE septum cap
Max Working Volume (ml)	0.8	0.7
Tube Height (mm)	36.9	36.9
Tube Height with Cap (mm)	40.3	38.1
Inner Diameter (mm)	6.5	6.5
Outer Diameter with Cap (mm)	8.7	8.7
Center to Center	9.0	9.0
Minimum Temperature (°C)	-196	-80
Tube Height in Rack (mm)	41.2	39
Overall Rack Height including lid (mm)	43.9	43.9

## Ordering Information



68-0801-00	0.8ml Tri-coded Tube, 96-format, External Thread, 2D Code on base, 1D Linear Barcode and Human Readable Number on side, uncapped, bulk, 960 tubes per case
68-0801-10	0.8ml Tri-coded Tube, 96-format, External Thread, 2D Code on base, 1D Linear Barcode and Human Readable Number on side, capped, bulk, 960 tubes per case
68-0801-01	0.8ml Tri-coded Tube, 96-format, External Thread, 2D Code on base, 1D Linear Barcode and Human Readable Number on side, uncapped, 10 racks per case, HighBase rack, empty rack part number: 66-51021
68-0801-11	0.8ml Tri-coded Tube, 96-format, External Thread, 2D Code on base, 1D Linear Barcode and Human Readable Number on side, capped, 10 racks per case, HighBase rack, empty rack part number: 66-51021
68-0802-00	0.8ml 2D-coded Tube, 96-format, External Thread, 2D Code on base, uncapped, bulk, 960 tubes per case
68-0802-10	0.8ml 2D-coded Tube, 96-format, External Thread, 2D Code on base, capped, bulk, 960 tubes per case
68-0802-01	0.8ml 2D-coded Tube, 96-format, External Thread, 2D Code on base, uncapped, 10 racks per case, HighBase rack, empty rack part number: 66-51021
68-0802-11	0.8ml 2D-coded Tube, 96-format, External Thread, 2D Code on base, capped, 10 racks per case, HighBase rack, empty rack part number: 66-51021



# 1.0ml Tri-coded Tube, 96-format, External Thread



- Supplied in 96-well format SBS racks or bulk
- Securely sealed using screw caps or TPE septum caps

	1.0ml screw cap	1.0ml TPE septum cap
		
	1.0ml Tri-coded Tube, 96-format, External Thread with screw cap	1.0ml Tri-coded Tube, 96-format, External Thread with TPE septum cap
Max Working Volume (ml)	1.0	0.9
Tube Height (mm)	46.2	46.2
Tube Height with Cap (mm)	49.6	47.4
Inner Diameter (mm)	6.5	6.5
Outer Diameter with Cap (mm)	8.7	8.7
Center to Center	9.0	9.0
Minimum Temperature (°C)	-196	-80
Tube Height in Rack (mm)	50.5	47.1
Overall Rack Height including lid (mm)	53.2	53.2

## Ordering Information

68-1003-00	1.0ml Tri-coded Tube, 96-format, External Thread, 2D Code on base, 1D Linear Barcode and Human Readable Number on side, uncapped, bulk, 960 tubes per case
68-1003-10	1.0ml Tri-coded Tube, 96-format, External Thread, 2D Code on base, 1D Linear Barcode and Human Readable Number on side, capped, bulk, 960 tubes per case
68-1003-01	1.0ml Tri-coded Tube, 96-format, External Thread, 2D Code on base, 1D Linear Barcode and Human Readable Number on side, uncapped, 10 racks per case, HighBase rack, empty rack part number: 66-51020
68-1003-11	1.0ml Tri-coded Tube, 96-format, External Thread, 2D Code on base, 1D Linear Barcode and Human Readable Number on side, capped, 10 racks per case, HighBase rack, empty rack part number: 66-51020
68-1004-00	1.0ml 2D-coded Tube, 96-format, External Thread, 2D Code on base, uncapped, bulk, 960 tubes per case
68-1004-10	1.0ml 2D-coded Tube, 96-format, External Thread, 2D Code on base, capped, bulk, 960 tubes per case
68-1004-01	1.0ml 2D-coded Tube, 96-format, External Thread, 2D Code on base, uncapped, 10 racks per case, HighBase rack, empty rack part number: 66-51020
68-1004-11	1.0ml 2D-coded Tube, 96-format, External Thread, 2D Code on base, capped, 10 racks per case, HighBase rack, empty rack part number: 66-51020





# 1.5ml Tri-coded Tube, 48-format, External Thread



- Supplied in 48-well format SBS racks or bulk, empty 9x9 cryo rack also available (see page 15)
- Securely sealed using screw caps

## 1.5ml screw cap



### 1.5ml Tri-coded Tube, 48-format, External Thread with screw cap

Max Working Volume (ml)	1.5
Tube Height (mm)	30.6
Tube Height with Cap (mm)	36.3
Inner Diameter (mm)	9.6
Outer Diameter with Cap (mm)	12.8
Center to Center	13.5
Minimum Temperature (°C)	-196
Tube Height in Rack (mm)	45.4
Overall Rack Height including lid (mm)	49.4

## Ordering Information

65-7660	1.5ml Tri-coded Tube, 48-format, External Thread, 2D Code on base, 1D Linear Barcode and Human Readable Number on side, uncapped, bulk, 480 tubes per case
65-7661	1.5ml Tri-coded Tube, 48-format, External Thread, 2D Code on base, 1D Linear Barcode and Human Readable Number on side, capped, bulk, 480 tubes per case
65-7662	1.5ml Tri-coded Tube, 48-format, External Thread, 2D Code on base, 1D linear barcode and Human Readable Number on side, uncapped, 10 racks per case, 48-format rack (1 piece rack base), empty rack part number: 65-9451
65-7663	1.5ml Tri-coded Tube, 48-format, External Thread, 2D Code on base, 1D Linear Barcode and Human Readable Number on side, capped, 10 racks per case, 48-format rack (1 piece rack base), empty rack part number: 65-9451
65-7664	1.5ml 2D-coded Tube, 48-format, External Thread, 2D Code on base, uncapped, bulk, 480 tubes per case
65-7665	1.5ml 2D-coded Tube, 48-format, External Thread, 2D Code on base, capped, bulk, 480 tubes per case
65-7666	1.5ml 2D-coded Tube, 48-format, External Thread, 2D Code on base, uncapped, 10 racks per case, 48-format rack (1 piece rack base), empty rack part number: 65-9451
65-7667	1.5ml 2D-coded Tube, 48-format, External Thread, 2D Code on base, capped, 10 racks per case, 48-format rack (1 piece rack base), empty rack part number: 65-9451
66-1801	Cryo Rack 9x9, black, polycarbonate, 10 racks per case, suitable for 1.5ml and 1.9ml External Thread Tubes

# 1.9ml Tri-coded Tube, 48-format, External Thread



- Supplied in 48-well format SBS racks or bulk, empty 10x10 cryo racks or 9x9 cryo racks also available (see page 15)
- Securely sealed using screw caps

## 1.9ml screw cap



### 1.9ml Tri-coded Tube, 48-format, External Thread with screw cap

Max Working Volume (ml)	1.9
Tube Height (mm)	38.2
Tube Height with Cap (mm)	43.9
Inner Diameter (mm)	9.6
Outer Diameter with Cap (mm)	12.8
Center to Center	13.5
Minimum Temperature (°C)	-196
Tube Height in Rack (mm)	45
Overall Rack Height including lid (mm)	49.4

## Ordering Information

65-7640	1.9ml Tri-coded Tube, 48-format, External Thread, 2D Code on base, 1D Linear Barcode and Human Readable Number on side, uncapped, bulk, 480 tubes per case
65-7641	1.9ml Tri-coded Tube, 48-format, External Thread, 2D Code on base, 1D Linear Barcode and Human Readable Number on side, capped, bulk, 480 tubes per case
65-7642	1.9ml Tri-coded Tube, 48-format, External Thread, 2D Code on base, 1D Linear Barcode and Human Readable Number on side, uncapped, 10 racks per case, 48-format rack (1 piece rack base), empty rack part number: 65-9451
65-7643	1.9ml Tri-coded Tube, 48-format, External Thread, 2D Code on base, 1D Linear Barcode and Human Readable Number on side, capped, 10 racks per case, 48-format rack (1 piece rack base), empty rack part number: 65-9451
65-7644	1.9ml 2D-coded Tube, 48-format, External Thread, 2D Code on base, uncapped, bulk, 480 tubes per case
65-7645	1.9ml 2D-coded Tube, 48-format, External Thread, 2D Code on base, capped, bulk, 480 tubes per case
65-7646	1.9ml 2D-coded Tube, 48-format, External Thread, 2D Code on base, uncapped, 10 racks per case, 48-format rack (1 piece rack base), empty rack part number: 65-9451
65-7647	1.9ml 2D-coded Tube, 48-format, External Thread, 2D Code on base, capped, 10 racks per case, 48-format rack (1 piece rack base), empty rack part number: 65-9451
66-1800	Cryo Rack 10x10, black, polycarbonate, 10 racks per case, suitable for 1.9ml External Thread Tubes



# 3.8ml Tri-coded Tube, 48-format, External Thread



- Supplied in 48-well format SBS racks or bulk
- Securely sealed with screw caps

## 3.8ml screw cap



## 3.8ml Tri-coded Tube, 48-format, External Thread with screw cap

Max Working Volume (ml)	3.8
Tube Height (mm)	75.0
Tube Height with Cap (mm)	80.7
Inner Diameter (mm)	9.6
Outer Diameter with Cap (mm)	12.8
Center to Center	13.5
Minimum Temperature (°C)	-196
Tube Height in Rack (mm)	81.7
Overall Rack Height including lid (mm)	86.2

## Ordering Information

65-7516	3.8ml Tri-coded Tube, 48-format, External Thread, 2D Code on base, 1D Linear Barcode and Human Readable Number on side, uncapped, bulk, 480 tubes per case
65-7517	3.8ml Tri-coded Tube, 48-format, External Thread, 2D Code on base, 1D Linear Barcode and Human Readable Number on side, capped, bulk, 480 tubes per case
65-7514	3.8ml Tri-coded Tube, 48-format, External Thread, 2D Code on base, 1D Linear Barcode and Human Readable Number on side, uncapped, 10 racks per case, 48-format rack (2 piece rack base), empty rack part number: 65-9460
65-7515	3.8ml Tri-coded Tube, 48-format, External Thread, 2D Code on base, 1D Linear Barcode and Human Readable Number on side, capped, 10 racks per case, 48-format rack (2 piece rack base), empty rack part number: 65-9460

# 7.6ml Tri-coded Tube, 24-format, External Thread



- Supplied bulk, empty 24-format SBS racks available separately
- Securely sealed with screw caps

## 7.6ml screw cap



### 7.6ml Tri-coded Tube, 24-format, External Thread with screw cap

Max Working Volume (ml)	7.6
Tube Height (mm)	77.4
Tube Height with Cap (mm)	83.6
Inner Diameter (mm)	13.0
Outer Diameter with Cap (mm)	17.0
Center to Center	18.0
Minimum Temperature (°C)	-196
Tube Height in Rack (mm)	84.7
Overall Rack Height including lid (mm)	88.5

## Ordering Information

65-9303	7.6ml Tri-coded Tube, 24-format, External Thread, 2D Code on base, 1D Linear Barcode and Human Readable Number on side, uncapped, bulk, 240 tubes per case
66-9302	7.6ml Tri-coded Tube, 24-format, External Thread, 2D Code on base, 1D Linear Barcode and Human Readable Number on side, capped with Automation Friendly Screw Cap, bulk, 240 tubes per case

## Large format Caps

66-9401	Screw Cap, 24-format, External Thread, orange, automation friendly, bulk, 240 caps per case, suitable for 2.2ml Tissue Tube, and 7.6ml Tubes
---------	--

## Large format Racks

66-9455	Rack, 24-format, 1 piece rack base, with open bottom for reading on rack readers, 10 racks per case, suitable for 7.6ml External Thread, Tri-coded Tubes (part number 66-9302)
---------	--



# 0.48ml Tri-coded Tube, 96-format, Internal Thread



- Supplied in 96-well format SBS racks or bulk
- Securely sealed with screw caps or TPE septum caps

	0.48ml screw cap	0.48ml TPE septum cap
		
	0.48ml Tri-coded Tube, 96-format Internal Thread with screw cap	0.48ml Tri-coded Tube, 96-format Internal Thread with TPE septum cap
Max Working Volume (ml)	0.48	0.57
Tube Height (mm)	26.4	26.4
Tube Height with Cap (mm)	34.7	27.6
Inner Diameter (mm)	6.8	6.8
Outer Diameter with Cap (mm)	8.6	8.6
Center to Center	9.0	9.0
Minimum Temperature (°C)	-196	-80
Tube Height in Rack (mm)	36.2	35.2
Overall Rack Height including lid (mm)	44.9	43.9

## Ordering Information

67-0753-00	0.48ml Tri-coded Tube, 96-format, Internal Thread, 2D Code on base, 1D Linear Barcode and Human Readable Number on side, uncapped, bulk, 960 tubes per case
67-0753-10	0.48ml Tri-coded Tube, 96-format, Internal Thread, 2D Code on base, 1D Linear Barcode and Human Readable Number on side, capped, bulk, 960 tubes per case
67-0753-02	0.48ml Tri-coded Tube, 96-format, Internal Thread, 2D Code on base, 1D Linear Barcode and Human Readable Number on side, uncapped, 10 racks per case, HighBase rack, empty rack part number: 66-51025
67-0753-12	0.48ml Tri-coded Tube, 96-format, Internal Thread, 2D Code on base, 1D Linear Barcode and Human Readable Number on side, capped, 10 racks per case, HighBase rack, empty rack part number: 66-51025



# 0.65ml Tri-coded Tube, 96-format, Internal Thread



- Supplied in 96-well format SBS racks or bulk
- Securely sealed with screw caps or TPE septum caps

	0.65ml screw cap	0.65ml TPE septum cap
		
	0.65ml Tri-coded Tube, 96-format, Internal Thread with screw cap	0.65ml Tri-coded Tube, 96-format, Internal Thread with TPE septum cap
Max Working Volume (ml)	0.65	0.75
Tube Height (mm)	36.8	36.8
Tube Height with Cap (mm)	45.1	38.0
Inner Diameter (mm)	6.8	6.8
Outer Diameter with Cap (mm)	8.4	8.4
Center to Center	9.0	9.0
Minimum Temperature (°C)	-196	-80
Tube Height in Rack (mm)	46	38.9
Overall Rack Height including lid (mm)	50.8	43.9

## Ordering Information



67-0755-00	0.65ml Tri-coded Tube, 96-format, Internal Thread, 2D Code on base, 1D Linear Barcode and Human Readable Number on side, uncapped, bulk, 960 tubes per case
67-0755-01	0.65ml Tri-coded Tube, 96-format, Internal Thread, 2D Code on base, 1D Linear Barcode and Human Readable Number on side, uncapped, 10 racks per case, HighBase rack, empty rack part number: 66-51022
67-0755-10	0.65ml Tri-coded Tube, 96-format, Internal Thread, 2D Code on base, 1D Linear Barcode and Human Readable Number on side, capped, bulk, 960 tubes per case
67-0755-11	0.65ml Tri-coded Tube, 96-format, Internal Thread, 2D Code on base, 1D Linear Barcode and Human Readable Number on side, capped, 10 racks per case, HighBase rack, empty rack part number: 66-51022



# 0.9ml Tri-coded Tube, 96-format, Internal Thread



- Supplied in 96-well format SBS racks or bulk
- Securely sealed with screw caps

	0.9ml screw cap	0.9ml TPE septum cap
		
	0.9ml Tri-coded Tube, 96-format Internal Thread with screw cap	0.9ml Tri-coded Tube, 96-format, Internal Thread with TPE septum cap
Max Working Volume (ml)	0.9	0.99
Tube Height (mm)	44.2	44.2
Tube Height with Cap (mm)	52.5	45.4
Inner Diameter (mm)	6.8	6.8
Outer Diameter with Cap (mm)	8.4	8.6
Center to Center	9.0	9.0
Minimum Temperature (°C)	-196	-80
Tube Height in Rack (mm)	53.4	46.3
Overall Rack Height including lid (mm)	61.8	50.8

## Ordering Information

67-0757-00	0.9ml Tri-coded Tube, 96-format, Internal Thread, 2D Code on base, 1D Linear Barcode and Human Readable Number on side, uncapped, bulk, 960 tubes per case
67-0757-10	0.9ml Tri-coded Tube, 96-format, Internal Thread, 2D Code on base, 1D Linear Barcode and Human Readable Number on side, capped, bulk, 960 tubes per case
67-0757-01	0.9ml Tri-coded Tube, 96-format, Internal Thread, 2D Code on base, 1D Linear Barcode and Human Readable Number on side, uncapped, 10 racks per case, HighBase rack, empty rack part number: 66-51023
67-0757-11	0.9ml Tri-coded Tube, 96-format, Internal Thread, 2D Code on base, 1D Linear Barcode and Human Readable Number on side, capped, 10 racks per case, HighBase rack, empty rack part number: 66-51023



# Dual-Coded Sample Tubes





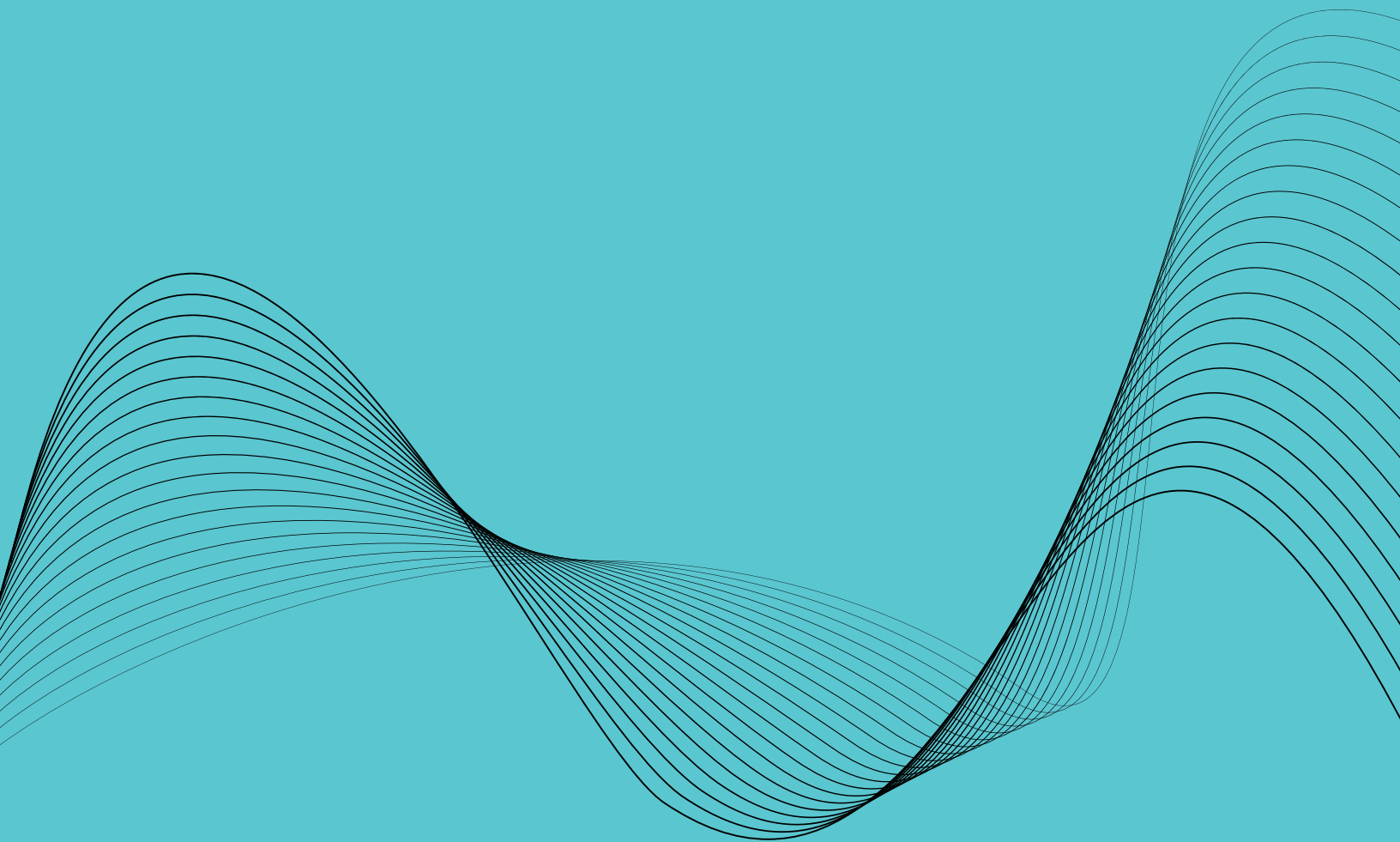

**AZENTA**  
LIFE SCIENCES

# Introduction to 96-Format Dual-Coded Tubes

## Overview

The Dual-Coded Tube features a 2D-code and Human Readable Number (HRN) on the tube base, allowing compatibility with low throughput manual workflows, semi-automated workflows or fully automated workflows on integrated platforms.

The tubes provide a lifelong and secure chain of custody for samples in biobanks, compound libraries and a broad range of biological and chemical stores, including cryogenic storage.

Designed and developed with broad compatibility in mind, the tubes perform without compromise in conjunction with automated barcode reading, capping and sample management systems from Azenta and all other industry-recognized manufacturers.



*Dual-Coded tube  
internal thread*

## Key Features

- Permanently laser etched, 2D-code and a Human Readable Number (HRN) on the tube base
- Developed to exceed the demands of sample security, management and tracking in modern high-density storage
- 100% Quality Control, each tube is tested to ensure both readability and uniqueness
- Manufactured using an advanced process which results in a one-piece tube from high-quality virgin polypropylene
- 2D-code and HRN ensure a permanent link between sample and data
- High-contrast 2D-codes are more reliably readable in frost or condensation conditions
- 2D-codes can be scanned and decoded without removing tubes from storage racks, enabling data to be associated with individual tubes
- Equally suitable for sealing with either screw caps or TPE septum caps
- Azenta tubes have been leak tested to ensure sample security
- Suitable for cryogenic storage
- Manufactured from high-quality virgin polypropylene

### Screw Caps

- Automation friendly co-molded screw caps for internal thread tubes eliminate the possibility of over tightening
- Co-molded caps eliminate the failures in caps using a silicone O-ring
- A double-start thread engages in a maximum rotation of 180°, thereby facilitating automation

## 96-Well Format SBS Racks

- **TwistLock:** prevents tubes rotating within the rack to enable automated capping and de-capping of screw caps, provided as standard
- **LidLock:** racks fitted with a LidLock latch are designed to withstand a 1m drop test for added sample security
- **TubeLock:** tubes can be locked in position in a rack, even without a lid, preventing them from falling out even if the rack is inverted. Lock or unlock simply by pushing the tube downwards or upwards
- **Automatic Rack Orientation:** racks are supplied with a unique 2D code identifier which can be read at the same time as the tube 2D code, to provide automatic rack orientation and more secure sample tracking
- **Direct Laser Etching:** linear barcodes are permanently etched directly onto the rack

## 14 x 14 Cryo Storage Racks

- 136.2mm x 136.2mm polycarbonate cryobox rack option available for cryogenic sample storage
- Holds 196 tubes in 14 x 14 array
- Open bottom for 2D code decoding on Azenta Camera-Based Reader for SBS Racks and Cryo Boxes
- Cryo racks can be supplied with a unique 2D code identifier which can be read at the same time as the tube 2D barcode, to provide more secure sample tracking



# 0.26ml Dual-coded Tube, 96-format, External Thread



- Supplied in 96-well format SBS racks or bulk
- Securely sealed using screw caps or TPE septum caps

	0.26ml screw cap	0.26ml septum cap
		
	0.26ml Dual-coded Tube, 96-format, External Thread with screw cap	0.26ml Dual-coded Tube, 96-format, External Thread with septum cap
Max Working Volume (ml)	0.26	0.23
Tube Height (mm)	15.2	15.2
Tube Height with Cap (mm)	18.6	16.4
Inner Diameter (mm)	6.5	6.5
Outer Diameter with Cap (mm)	8.7	8.7
Center to Center	9.0	9.0
Minimum Temperature (°C)	-196	-80
Tube Height in Rack (mm)	19.13	15.73
Overall Rack Height including lid (mm)	22	22

## Ordering Information

<b>68-0303-00</b>	0.26ml Dual-coded Tube, 96-format, External Thread, 2D Code on base, 2D and Human Readable Number on side, uncapped, bulk, 960 tubes per case
<b>68-0303-10</b>	0.26ml Dual-coded Tube, 96-format, External Thread, 2D Code on base, 2D and Human Readable Number on side, capped, bulk, 960 tubes per case
<b>68-0303-01</b>	0.26ml Dual-coded Tube, 96-format, External Thread, 2D Code on base, 2D and Human Readable Number on side, uncapped, 10 racks per case, LowBase rack, 2D rack ID position H12, empty rack part number: 68-0300-20
<b>68-0303-11</b>	0.26ml Dual-coded Tube, 96-format, External Thread, 2D Code on base, 2D and Human Readable Number on side, capped, 10 racks per case, LowBase rack, 2D rack ID position H12, empty rack part number: 68-0300-20

Note: available with 2D-code only on request.



**AZENTA**  
LIFE SCIENCES

# 0.3ml Dual-coded Tube, 96-format, Internal Thread



- Supplied in 96-well format SBS racks, or bulk compatible with 14x14 cryo storage racks
- Securely sealed with screw caps or TPE septum caps

## 0.3ml screw cap



## 0.3ml Dual-coded Tube, 96-format, Internal Thread with screw cap

Max Working Volume (ml)	0.33
Tube Height (mm)	21
Tube Height with Cap (mm)	29.3
Inner Diameter (mm)	6.8
Outer Diameter with Cap (mm)	8.7
Center to Center	9
Minimum Temperature (°C)	-196
Tube Height in Rack (mm)	29.5
Overall Rack Height including lid (mm)	33.1

## Ordering Information

<b>66-62326</b>	0.3ml Dual-coded Tube, 96-format, Internal Thread, 2D Code and Human Readable Number on base, uncapped, bulk, 960 tubes per case
<b>66-62326-Y6</b>	0.3ml Dual-coded Tube, 96-format, Internal Thread, 2D Code and Human Readable Number on base, capped, bulk, 960 tubes per case
<b>66-62325</b>	0.3ml Dual-coded Tube, 96-format, Internal Thread, 2D Code and Human Readable Number on base, uncapped, 10 racks per case, LowBase rack, empty rack part number: 66-51004
<b>66-62325-Y6</b>	0.3ml Dual-coded Tube, 96-format, Internal Thread, 2D Code and Human Readable Number on base, capped, 10 racks per case, LowBase rack, empty rack part number: 66-51004



# 0.7ml Dual-coded Tube, 96-format, Internal Thread



- Supplied in 96-well format SBS racks or bulk
- Securely sealed with screw caps or TPE septum caps

## 0.7ml screw cap



## 0.7ml Dual-coded Tube, 96-format, Internal Thread with screw cap

Max Working Volume (ml)	0.73
Tube Height (mm)	36.2
Tube Height with Cap (mm)	44.5
Inner Diameter (mm)	6.8
Outer Diameter with Cap (mm)	8.6
Center to Center	9
Minimum Temperature (°C)	-196
Tube Height in Rack (mm)	46.4
Overall Rack Height including lid (mm)	50.8

## Ordering Information

<b>66-62318</b>	0.7ml Dual-coded Tube, 96-format, Internal Thread, 2D Code and Human Readable Number on base, <b>uncapped</b> , bulk, 960 tubes per case
<b>66-62318-Y6</b>	0.7ml Dual-coded Tube, 96-format, Internal Thread, 2D Code and Human Readable Number on base, <b>capped</b> , bulk, 960 tubes per case
<b>66-62319</b>	0.7ml Dual-coded Tube, 96-format, Internal Thread, 2D Code and Human Readable Number on base, <b>uncapped</b> , 10 racks per case, HighBase rack, empty rack part number: 66-61002
<b>66-62319-Y6</b>	0.7ml Dual-coded Tube, 96-format, Internal Thread, 2D Code and Human Readable Number on base, <b>capped</b> , 10 racks per case, HighBase rack, empty rack part number: 66-61002

# 0.9ml Dual-coded Tube, 96-format, Internal Thread



- Supplied in 96-well format SBS racks or bulk
- Securely sealed with screw caps or TPE septum caps

## 0.9ml screw cap



## 0.9ml Dual-coded Tube, 96-format, Internal Thread with screw cap

Max Working Volume (ml)	0.92
Tube Height (mm)	43.5
Tube Height with Cap (mm)	51.8
Inner Diameter (mm)	6.8
Outer Diameter with Cap (mm)	8.6
Center to Center	9
Minimum Temperature (°C)	-196
Tube Height in Rack (mm)	53.8
Overall Rack Height including lid (mm)	61.8

## Ordering Information

<b>66-62345</b>	0.9ml Dual-coded Tube, 96-format, Internal Thread, 2D Code and Human Readable Number on base, uncapped, bulk, 960 tubes per case
<b>66-62345-Y6</b>	0.9ml Dual-coded Tube, 96-format, Internal Thread, 2D Code and Human Readable Number on base, capped, bulk, 960 tubes per case
<b>66-62330</b>	0.9ml Dual-coded Tube, 96-format, Internal Thread, 2D Code and Human Readable Number on base, uncapped, 10 racks per case, HighBase rack, lid suitable for Screw Caps and TPE Caps, empty rack part number: 66-61003
<b>66-62330-Y6</b>	0.9ml Dual-coded Tube, 96-format, Internal Thread, 2D Code and Human Readable Number on base, capped, 10 racks per case, HighBase rack, lid suitable for Screw Caps and TPE Caps, empty rack part number: 66-61003



# 0.5ml Dual-coded Tube, 96-format, External Thread



- Supplied in 96-well format SBS racks or bulk
- Securely sealed with screw caps or TPE septum caps

## 0.5ml screw cap



## 0.5ml Dual-coded Tube, 96-format, External Thread with screw cap

Max Working Volume (ml)	0.55
Tube Height (mm)	26.4
Tube Height with Cap (mm)	29.8
Inner Diameter (mm)	6.5
Outer Diameter with Cap (mm)	8.5
Center to Center	9
Minimum Temperature (°C)	-196
Tube Height in Rack (mm)	30.0
Overall Rack Height including lid (mm)	33.1

## Ordering Information

68-0701-00	0.5ml Dual-coded Tube, 96-format, External Thread, 2D Code and Human Readable Number on base, uncapped, bulk, 960 tubes per case
68-0701-10	0.5ml Dual-coded Tube, 96-format, External Thread, 2D Code and Human Readable Number on base, capped, bulk, 960 tubes per case
68-0701-02	0.5ml Dual-coded Tube, 96-format, External Thread, 2D Code and Human Readable Number on base, uncapped, 10 racks per case, HighBase rack, empty rack part number: 66-51026
68-0701-12	0.5ml Dual-coded Tube, 96-format, External Thread, 2D Code and Human Readable Number on base, capped, 10 racks per case, HighBase rack, empty rack part number: 66-51026
68-0701-11	0.5ml Dual-coded Tube, 96-format, External Thread, 2D Code and Human Readable Number on base, capped, 10 racks per case, LowBase rack, empty rack part number: 66-51004



# 0.9ml Dual-coded Tube, 96-format, External Thread



- Supplied in 96-well format SBS racks or bulk
- Securely sealed with screw caps or TPE septum caps

## 0.9ml screw cap



## 0.9ml Dual-coded Tube, 96-format, External Thread with screw cap

Max Working Volume (ml)	0.9
Tube Height (mm)	42.3
Tube Height with Cap (mm)	45.7
Inner Diameter (mm)	6.5
Outer Diameter with Cap (mm)	8.7
Center to Center	9
Minimum Temperature (°C)	-196
Tube Height in Rack (mm)	47.8
Overall Rack Height including lid (mm)	50.8

## Ordering Information

<b>68-1001-00</b>	<b>0.9ml Dual-coded Tube, 96-format, External Thread, 2D Code and Human Readable Number on base, uncapped, bulk, 960 tubes per case</b>
<b>68-1001-10</b>	<b>0.9ml Dual-coded Tube, 96-format, External Thread, 2D Code and Human Readable Number on base, capped, bulk, 960 tubes per case</b>
<b>68-1001-01</b>	<b>0.9ml Dual-coded Tube, 96-format, External Thread, 2D Code and Human Readable Number on base, uncapped, 10 racks per case, HighBase rack, empty rack part number: 66-61002</b>
<b>68-1001-11</b>	<b>0.9ml Dual-coded Tube, 96-format, External Thread, 2D Code and Human Readable Number on base, capped, 10 racks per case, HighBase rack, empty rack part number: 66-61002</b>
<b>66-61002</b>	<b>Rack, 96-format, HighBase, 10 racks per case, suitable for 0.7ml Internal Thread Tubes with Screw Caps, 0.9ml Internal Thread, Dual-Coded Tubes with Septum TPE Caps or Individual Thermal Seals and 0.9ml External Thread Tubes with Screw Caps</b>
<b>66-51016</b>	<b>Rack, 96-format, HighBase, with TubeLock, 10 racks per case, suitable for 0.9ml External Thread Tubes with Screw Caps or Septum TPE Caps, 0.7ml Internal Thread Tubes with Screw Caps or Septum TPE Caps and 0.9ml Internal Thread Tubes with Septum TPE Caps</b>
<b>66-0196-01</b>	<b>Cryo Rack 14x14, black, polycarbonate, 10 racks per case, suitable for 0.3ml and 0.48ml Internal Thread Tubes and 0.5ml External Thread Tubes</b>





BACK

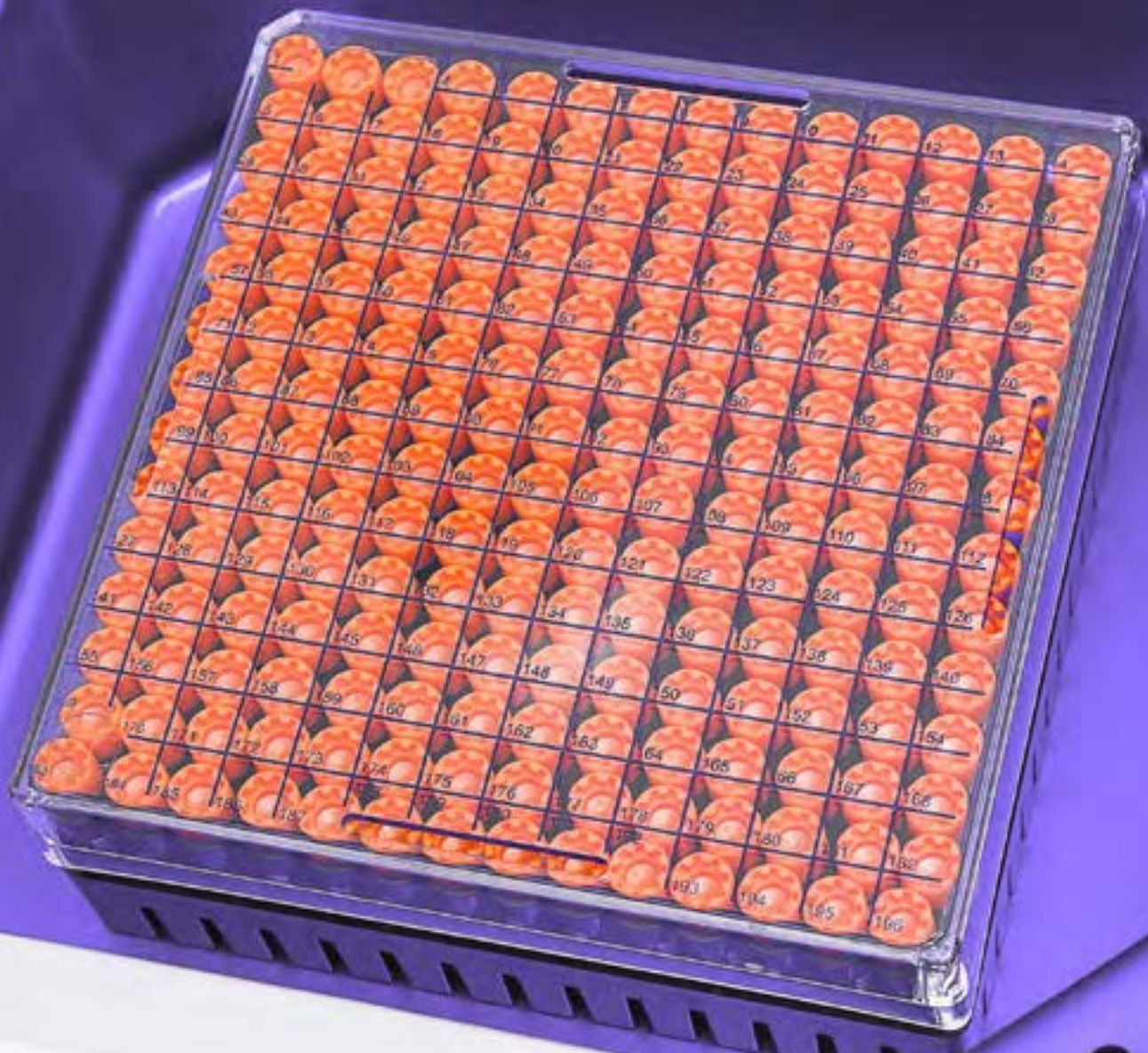

**CAUTION**

**EXTREME COLD.**  
Liquid Nitrogen inside.  
Use appropriate personal protective equipment  
when filling liquid nitrogen manually.



# 2D-Coded Sample Tubes



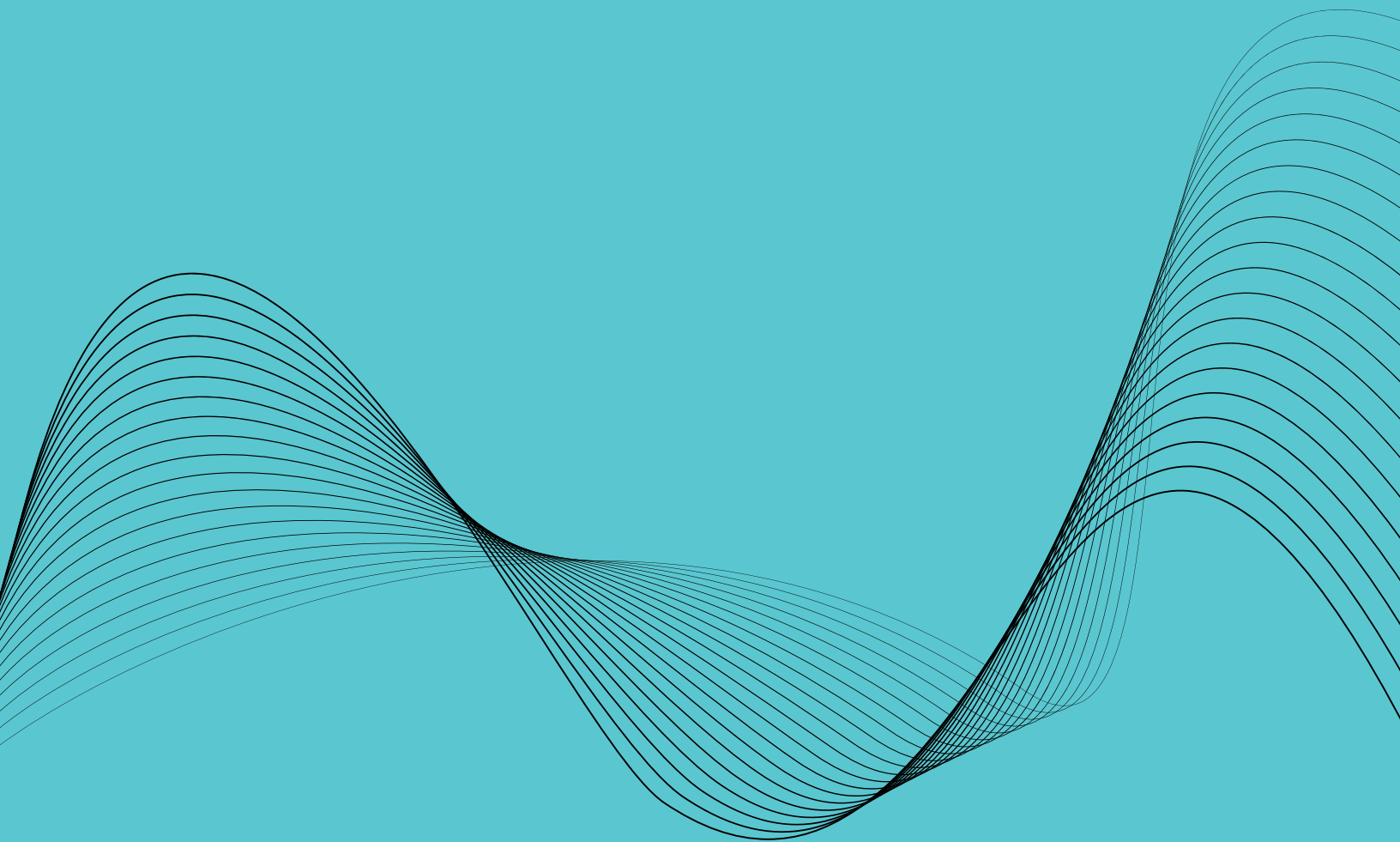

**AZENTA**  
LIFE SCIENCES

# External Thread 2D-Coded Tubes

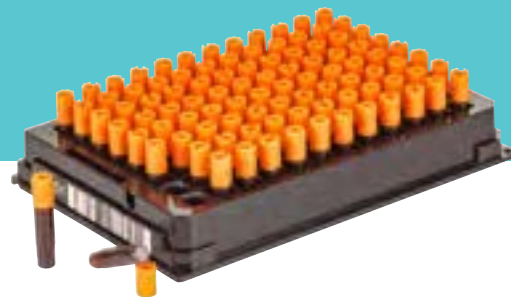

External Thread 2D-coded tubes carry a unique and permanent high-contrast 2D-code tube identifier on the base of the tube readable in frost or condensation conditions, or when damaged. The tubes provide a lifelong and secure chain of custody for samples in biobanks, compound libraries and a broad range of biological and chemical stores, including cryogenic storage.

## Key Features

- Permanently laser etched, 2D-code on base
- 100% Quality Control, each tube is tested to ensure both readability and uniqueness
- Manufactured from high-quality virgin polypropylene
- External thread tubes provide greater working volume than internal thread tubes
- Suitable for cryogenic storage as low as  $-196^{\circ}\text{C}$
- Secure Sample Storage and Tracking
- Available bulk uncapped or capped

- Available pre-racked and capped in 96, 48 and 24 well format SBS racks
- 2D-codes readable without removing tubes from racks

### Screw Caps

- A deforming compression seal is more effective than a silicone alternative
- Non-silicone seal means the cap can never be over-tightened
- Caps and tubes are manufactured from the same material, preventing differential expansion during freeze-thaw cycles
- A double-start thread engages in a maximum rotation of  $180^{\circ}$  thereby facilitating automation

# Internal Thread 2D-Coded Tubes

2D-coded internal thread tubes carry a unique and permanent high-contrast 2D-code tube identifier on the base of the tube providing a lifelong and secure chain of custody for samples in biobanks, compound libraries and a broad range of biological and chemical stores, including cryogenic storage.

## Key Features

- Permanently laser etched, 2D-code on base
- 100% Quality Control, each tube is tested to ensure both readability and uniqueness
- Manufactured from high-quality virgin polypropylene
- Suitable for cryogenic storage as low as  $-196^{\circ}\text{C}$
- Secure sample storage and tracking
- Available bulk uncapped or capped
- Available pre-racked and capped in 96, 48 and 24 well format SBS racks
- 2D-codes readable without removing tubes from racks

### Screw Caps

- Co-molded screw caps for internal thread tubes eliminate the possibility of over-tightening
- Co-molded caps eliminate the failures common in caps using silicon O-rings
- Improved internal thread provides a more secure seal when using screw caps

### TPE Septum Caps

- Cost-effective sealing option for samples that are only accessed occasionally
- Septum caps are supplied in 96-format back mats to facilitate automation



# Acoustic Sample Tube – Echo<sup>®</sup> Qualified Consumable

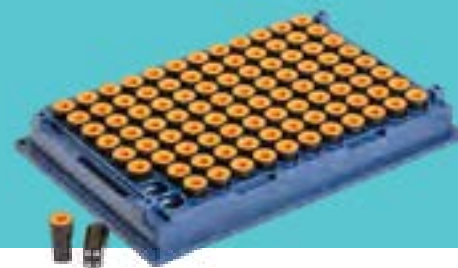

- Acoustic dispense direct from the tube
- Assay robustness based on a higher sample integrity
- Compound saving vs. Conventional storage methods
- Faster turnaround time from request for compound to compound ready for assay
- Established benefits of 2D-coded Tubes vs. Plates which have to be fully thawed and unsealed to access one sample
- Combined technologies of 2D-coded Tubes and Acoustic Transfer
- Unique and permanent 2D4 Quad Code laser-etched on tube base
- Secure Sample Storage and Tracking - barcode ensures a permanent link between sample and data
- Scan and decode without removing tubes from storage racks, enables data to be associated with individual tubes
- Leak tested to ensure sample security
- Screw Caps - non-silicone seal means the cap can never be overtightened
- Double-start thread engages in a maximum rotation of 180°, facilitating automation

## Acoustic Sample Tube – Echo<sup>®</sup> Qualified Consumable



Acoustic Sample Tube – Echo<sup>®</sup> Qualified Consumable

<b>Max Working Volume</b>	70 $\mu$ L @5mm
<b>Dead Volume</b>	Approx. 15 $\mu$ L (with DMSO)
<b>Total Volume</b>	85 $\mu$ L
<b>Rack Option</b>	SBS format 96-way rack
<b>Tube Height (mm)</b>	13.4
<b>Tube Height with Cap (mm)</b>	14.7
<b>Outer Diameter with Cap (mm)</b>	7.9
<b>Rack Height with lid (mm)</b>	22.1
<b>Coding</b>	2D4 Quad Code on base
<b>Capping Option</b>	Internal Thread

## Ordering Information

Please contact your local Azenta Life Sciences representative.

# Introduction to Dual-coded Tissue Tube, 24-format, External Thread

## Overview

Dual-coded tissue tubes are specifically designed for long-term storage of tissue samples. Suitable for cryogenic storage, tubes are supplied in 24-well format SBS racks or, bulk. The 2D-codes are readable without removing the tubes from their racks.

Dual-coded tissue tubes offer unequalled audit traceability, enabling sample tracking and data sharing between multiple labs, locations and automation capabilities. Tubes are manufactured from high-quality virgin polypropylene and are securely sealed using standard screw caps or automation-friendly screw caps.



## Key Features

- Secure Sample Storage and Tracking Optimized for Tissue Sample Storage
- Flat Bottom for easy sample extraction
- Straight sides optimized for forceps use
- Holds samples up to 9.5mm in size, ideal for samples between 5-7mm
- External thread is easy to tighten with gloves or forceps,
- Permanently laser etched, 2D-code on tube base
- Permanently laser etched, 2D-code and Human Readable number on tube side
- Dual-Coded tube supports sample sharing between labs and locations
- 100% Quality control, each tube is tested to ensure code readability and uniqueness
- Azenta tubes have been leak tested to ensure sample security
- Suitable for cryogenic storage
- Manufactured from high-quality virgin polypropylene

### Screw Caps

- Automation friendly cap option

### 24-Format SBS Racks

- Automation Rack Orientation: racks are supplied with a unique 2D-code which can be read at the same time as the tube 2D-code, to provide automatic rack orientation and more secure sample tracking
- Direct Laser Etching: linear barcodes are permanently laser etched directly onto the rack



# 2.2ml Dual-coded Tissue Tube, 24-format, External Thread

2.2ml screw cap		
	Max Working Volume (ml)	2.2
	Tube Height (mm)	25.9
	Tube Height with Cap (mm)	32.1
	Inner Diameter (mm)	13.1
	Outer Diameter with Cap (mm)	17.0
	Center to Center	18.0
	Minimum Temperature (°C)	-196
2.2ml Tissue Tube with screw cap	Tube Height in Rack (mm)	33.8
	Overall Rack Height including lid (mm)	35.7

## Ordering Information

68-4000-00	2.2ml Dual-coded Tissue Tube, 24-format, External Thread, flat bottom, 2D Code on base, 2D and Human Readable Number on side, uncapped, bulk, 240 tubes per case
68-4000-31	2.2ml Dual-coded Tissue Tube, 24-format, External Thread, flat bottom, 2D Code on base, 2D code and Human Readable Number on side, capped with clear Automation Friendly Screw Cap, bulk, 240 tubes per case
68-4000-33	2.2ml Dual-coded Tissue Tube, 24-format, External Thread, flat bottom, 2D Code on base, 2D and Human Readable Number on side, capped with clear Automation Friendly Screw Cap, 10 racks per case, 24-format rack, without TwistLock, empty rack part number: 68-4000-22

## Tissue Tube Caps

66-9402	Screw Cap, 24-format, External Thread, clear, automation friendly, bulk, 240 caps per case, suitable for 2.2ml Tissue Tube, and 7.6ml Tubes
66-9401	Screw Cap, 24-format, External Thread, orange, automation friendly, bulk, 240 caps per case, suitable for 2.2ml Tissue Tube, and 7.6ml Tubes

## Tissue Tube Racks

68-4000-22	Rack, 24-format, without TwistLock, 10 racks per case, suitable for Tissue Tubes with automation friendly caps
------------	--



# 0.2ml 2D-coded Tube, 96-format, External Thread



- Supplied in 96-well format SBS racks
- Securely sealed using screw caps
- Available in 240-well format on request

0.2ml screw cap



0.2ml 2D-coded Tube, 96-format, External Thread with screw cap

Max Working Volume (ml)	0.2
Tube Height (mm)	24.1
Tube Height with Cap (mm)	27.5
Inner Diameter (mm)	3.9
Outer Diameter with Cap (mm)	5.8
Center to Center	9.0
Minimum Temperature (°C)	-196
Tube Height in Rack (mm)	28
Overall Rack Height including lid (mm)	31

## Ordering Information

67-0203-01	0.2ml 2D-coded Tube, 96-format, External Thread, 2D Code on base, uncapped, bulk, 960 tubes per case
67-0203-10	0.2ml 2D-coded Tube, 96-format, External Thread, 2D Code on base, capped, bulk, 960 tubes per case
67-0203-02	0.2ml 2D-coded Tube, 96-format, External Thread, 2D Code on base, uncapped, 10 racks per case, empty rack part number: 67-0203-00
67-0203-11	0.2ml 2D-coded Tube, 96-format, External Thread, 2D Code on base, capped, 10 racks per case, empty rack part number: 67-0203-00
67-0203-51	Screw Cap, 96-format, External Thread, bulk, 960 caps per case, suitable for 0.2ml 2D-coded Tube, 96-format, External Thread
67-0203-00	Rack, 96-format, 10 racks per case, suitable for 0.2ml Tubes
67-0200-00	Rack, 240-format, 10 racks per case, suitable for 0.2ml Tubes





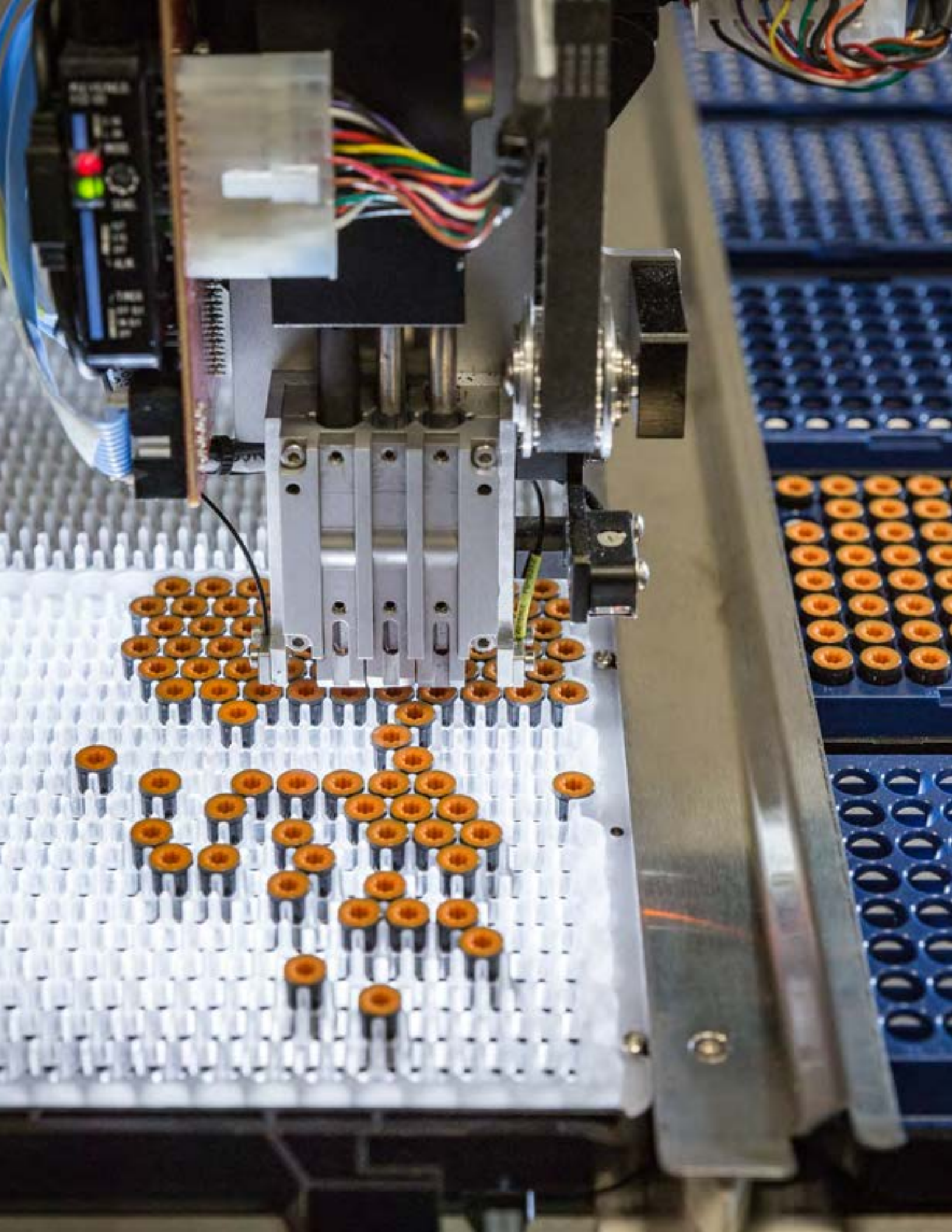

# Non-Coded Sample Storage Tubes



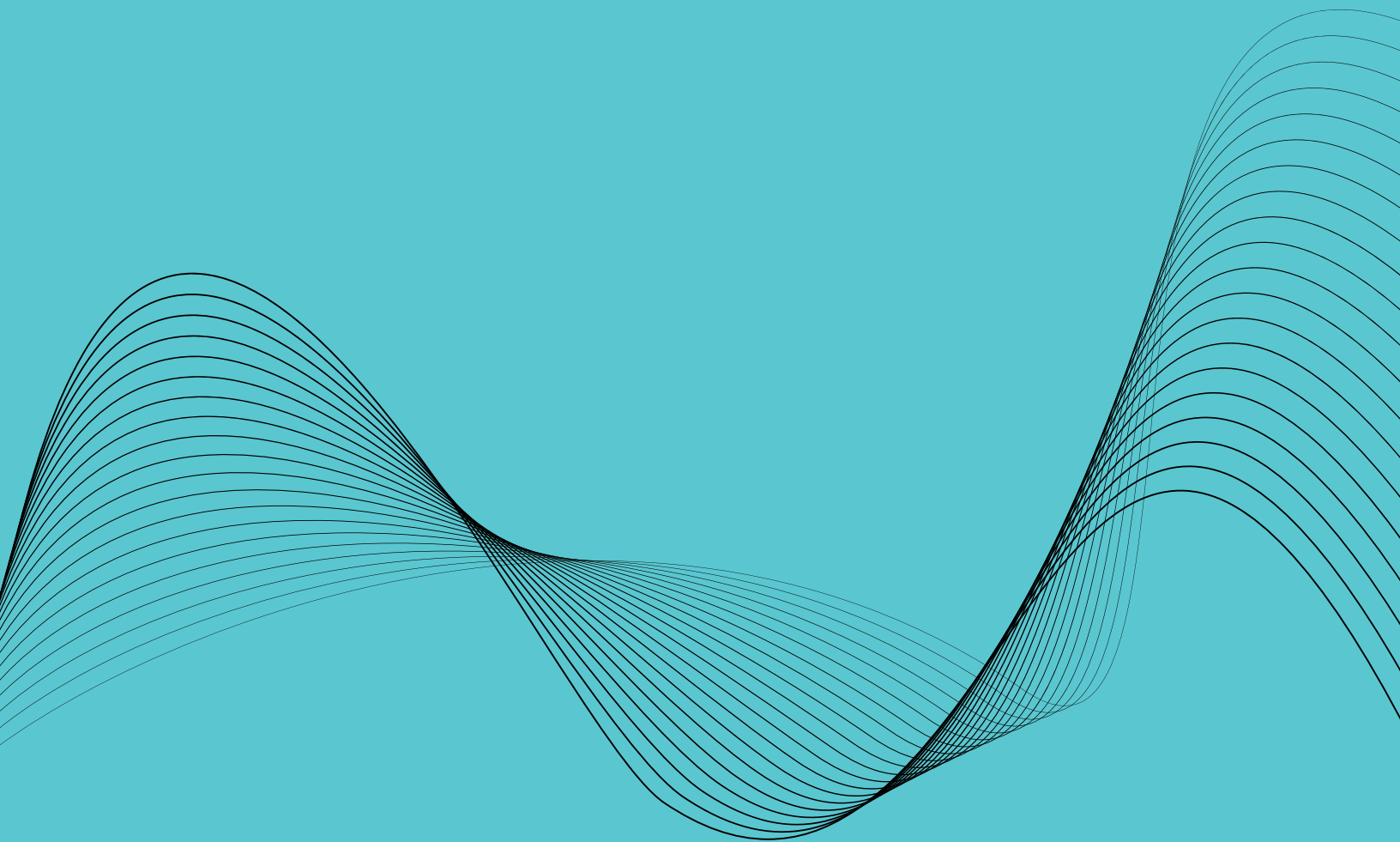

**AZENTA**  
LIFE SCIENCES

# Non-Coded Tubes

In addition to our fully traceable coded tubes offering sample security, management and tracking in modern high-density storage applications, Azenta tubes are also available non-coded or with alpha numeric coding.

## Ordering Information

### 0.5ml Non-Coded External Thread Screw Cap Tubes

66-0700-01	0.5ml Non-coded Tube, 96-format, External Thread, uncapped, 10 racks per case, LowBase rack, empty rack part number: 66-51004
66-0700-11	0.5ml Non-coded Tube, 96-format, External Thread, capped, 10 racks per case, LowBase rack, empty rack part number: 66-51004
66-0700-02	0.5ml Non-coded Tube, 96-format, External Thread, uncapped, 10 racks per case, HighBase rack, empty rack part number: 66-51026
66-0700-12	0.5ml Non-coded Tube, 96-format, External Thread, capped, 10 racks per case, HighBase rack, empty rack part number: 66-51026
66-0700-00	0.5ml Non-coded Tube, 96-format, External Thread, uncapped, bulk, 960 tubes per case
66-0700-10	0.5ml Non-coded Tube, 96-format, External Thread, capped, bulk, 960 tubes per case

### 0.9ml Non-Coded External Thread Screw Cap Tubes

66-1000-01	0.9ml Non-coded Tube, 96-format, External Thread, uncapped, 10 racks per case, HighBase rack, empty rack part number: 66-61002
66-1000-11	0.9ml Non-coded Tube, 96-format, External Thread, capped, 10 racks per case, HighBase rack, empty rack part number: 66-61002
66-1000-02	0.9ml Non-coded Tube, 96-format, External Thread, uncapped, 10 racks per case, HighBase rack, with TubeLock, empty rack part number: 66-51016
66-1000-12	0.9ml Non-coded Tube, 96-format, External Thread, capped, 10 racks per case, HighBase rack, with TubeLock, empty rack part number: 66-51016
66-1000-00	0.9ml Non-coded Tube, 96-format, External Thread, uncapped, bulk, 960 tubes per case
66-1000-10	0.9ml Non-coded Tube, 96-format, External Thread, capped, bulk, 960 tubes per case



## Non-Coded Tubes

### 0.3ml Non-Coded Internal Thread Tubes

<b>66-32041</b>	<b>0.3ml Non-coded Tube, 96-format, Internal Thread, V-bottom, uncapped, 10 racks per case, LowBase rack, suitable for use with Screw Cap Tubes, empty rack part number: 66-51004</b>
<b>66-32041-Y6</b>	<b>0.3ml Non-coded Tube, 96-format, Internal Thread, V-bottom, capped, 10 racks per case, LowBase rack, empty rack part number: 66-51004</b>
<b>66-32041-Y6-L</b>	<b>0.3ml Non-coded Tube, 96-format, Internal Thread, V-bottom, capped, 10 racks per case, LowBase rack, with TubeLock, includes standard profile non-locking lid, empty rack part number: 66-51014</b>
<b>66-32141</b>	<b>0.3ml Non-coded Tube, 96-format, Internal Thread, uncapped, 10 racks per case, LowBase rack, lid suitable for use with TPE Caps/Thermal Individual Tube Seal only, empty rack part number: 66-51003</b>
<b>66-32040</b>	<b>0.3ml Non-coded Tube, 96-format, Internal Thread, V-bottom, uncapped, bulk, 960 tubes per case</b>
<b>66-32040-Y6</b>	<b>0.3ml Non-coded Tube, 96-format, Internal Thread, V-bottom, capped, bulk, 960 tubes per case</b>

### 0.7ml Non-Coded Internal Thread Tubes

<b>66-32033</b>	<b>0.7ml Non-coded Tube, 96-format, Internal Thread, V-bottom, uncapped, bulk, 960 tubes per case</b>
<b>66-32033-Y6</b>	<b>0.7ml Non-coded Tube, 96-format, Internal Thread, V-bottom, capped, bulk, 960 tubes per case</b>
<b>66-32034</b>	<b>0.7ml Non-coded Tube, 96-format, Internal Thread, V-bottom, uncapped, 10 racks per case, HighBase rack, empty rack part number: 66-61002</b>
<b>66-32034-Y6</b>	<b>0.7ml Non-coded Tube, 96-format, Internal Thread, V-bottom, capped, 10 racks per case, HighBase rack, empty rack part number: 66-61002</b>
<b>66-32034-L</b>	<b>0.7ml Non-coded Tube, 96-format, Internal Thread, V-bottom, uncapped, 10 racks per case, HighBase rack, with TubeLock, empty rack part number: 66-51016</b>
<b>66-32034-Y6-L</b>	<b>0.7ml Non-coded Tube, 96-format, Internal Thread, V-bottom, capped, 10 racks per case, HighBase rack, with TubeLock, empty rack part number: 66-51016</b>

### 0.9ml Non-Coded Internal Thread Screw Cap Tubes

<b>66-32062</b>	<b>0.9ml Non-coded Tube, 96-format, Internal Thread, V-bottom, uncapped, bulk, 960 tubes per case</b>
<b>66-32062-Y6</b>	<b>0.9ml Non-coded Tube, 96-format, Internal Thread, V-bottom, capped, bulk, 960 tubes per case</b>
<b>66-32042</b>	<b>0.9ml Non-coded Tube, 96-format, Internal Thread, uncapped, 10 racks per case, HighBase rack, lid suitable for TPE caps only, empty rack part number: 66-61002</b>
<b>66-32043</b>	<b>0.9ml Non-coded Tube, 96-format, Internal Thread, uncapped, 10 racks per case, HighBase rack, lid suitable for Screw Caps and TPE Caps, empty rack part number: 66-61003</b>
<b>66-32043-Y6</b>	<b>0.9ml Non-coded Tube, 96-format, Internal Thread, capped, 10 racks per case, HighBase rack, lid suitable for Screw Caps and TPE Caps, empty rack part number: 66-61003</b>
<b>66-32042-L</b>	<b>0.9ml Non-coded Tube, 96-format, Internal Thread, uncapped, 10 racks per case, HighBase rack, with TubeLock, lid suitable for TPE caps only, empty rack part number: 66-51016</b>
<b>66-32043-L</b>	<b>0.9ml Non-coded Tube, 96-format, Internal Thread, uncapped, 10 racks per case, HighBase rack, with TubeLock, lid suitable for Screw Caps and TPE Caps, empty rack part number: 66-51017</b>
<b>66-32043-Y6-L</b>	<b>0.9ml Non-coded Tube, 96-format, Internal Thread, capped, 10 racks per case, HighBase rack with TubeLock, empty rack part number: 66-51017</b>



# Capping and Sealing Options



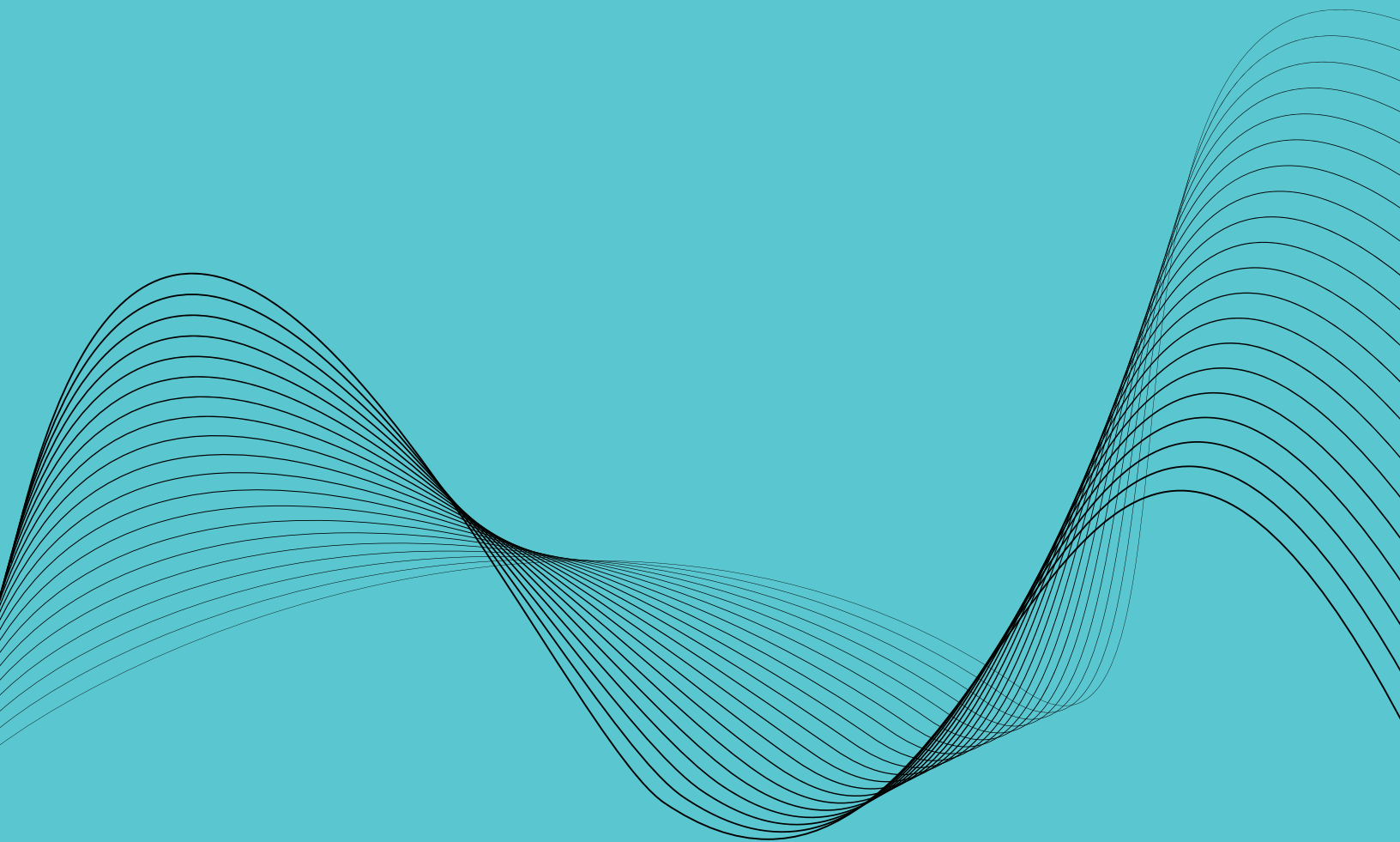

**AZENTA**  
LIFE SCIENCES

# Tube Screw Caps



Developed to exceed the demands of sample security, management and tracking in modern high-density storage applications, screw caps are manufactured from high-quality virgin polypropylene and are designed for optimal seal quality and sample security.

Compatible with all Azenta 96-format sample storage tubes with a screw top, caps are available for use with either external or internal thread Azenta screw top tubes and are supplied in bags of 960 caps.

## Practical Design Based on Experience of Applications

- High chemical resistance
- Broad operating temperature range -196°C to +121°C, do not use in liquid phase nitrogen
- Automation friendly, available in Azenta Cap Carrier for use with automated capping and de-capping systems
- Autoclavable
- Available in up to 10 different colors to aid sample identification
- Manufactured from high-quality virgin polypropylene

## Screw Caps for External Thread Tubes

- Deforming compression seal is more effective than a silicone alternative
- Non-silicone seal means the cap can never be over-tightened
- Cap and tube manufactured from the same material, preventing differential expansion during freeze-thaw cycles
- Double-start thread engages in a maximum rotation of 180°, facilitating automation

## Screw Caps for Internal Thread Tubes

- Co-molded screw caps for internal thread tubes eliminate the possibility of over-tightening
- Co-molded caps eliminate the failures common in caps using silicon O-rings
- Improved internal thread provides a more secure seal when using screw caps

## Designed for Reduced Sample Loss

- Significant amounts of liquid can become trapped within a standard design screw cap, resulting in potential loss of valuable sample
- This hollow area on the cap can catch sample, and surface tension then makes cap removal difficult
- Studies demonstrate that Azenta cap design, with a reduced hollow, reduces this effect by lowering liquid retention whilst maintaining seal quality

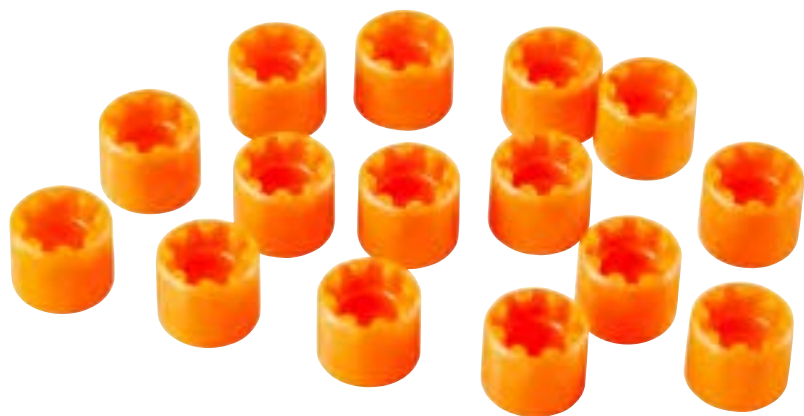



### Ordering Information

#### 96 Format External Thread Screw Caps

<b>68-53111-10N</b>	Cap Carrier (External Thread), with orange caps, 96-format, SBS stackable, re-usable, 10 carriers/960 caps per case, suitable for all 96-format External Thread Screw Cap Tubes
<b>68-53111-50N</b>	Cap Carrier (External Thread), with orange caps, 96-format, SBS stackable, re-usable, 50 carriers/4,800 caps per case, suitable for all 96-format External Thread Screw Cap Tubes
<b>68-53100-Z1N</b>	Screw Cap, 96-format, External Thread, white, bulk, 960 caps per case
<b>68-53100-Z2N</b>	Screw Cap, 96-format, External Thread, red, bulk, 960 caps per case
<b>68-53100-Z3N</b>	Screw Cap, 96-format, External Thread, yellow, bulk, 960 caps per case
<b>68-53100-Z4N</b>	Screw Cap, 96-format, External Thread, blue, bulk, 960 caps per case
<b>68-53100-Z5N</b>	Screw Cap, 96-format, External Thread, transparent blue, bulk, 960 caps per case
<b>68-53100-Z6N</b>	Screw Cap, 96-format, External Thread, orange, bulk, 960 caps per case
<b>68-53100-Z8N</b>	Screw Cap, 96-format, External Thread, green, bulk, 960 caps per case
<b>68-53100-Z10N</b>	Screw Cap, 96-format, External Thread, amber, bulk, 960 caps per case
<b>68-53100-Z11N</b>	Screw Cap, 96-format, External Thread, purple, bulk, 960 caps per case
<b>68-53100-Z12N</b>	Screw Cap, 96-format, External Thread, natural, bulk, 960 caps per case
<b>68-53100-Z13N</b>	Screw Cap, 96-format, External Thread, black, bulk, 960 caps per case

#### 48 Format External Thread Screw Caps

<b>65-7572</b>	Screw Cap, 48-format, External Thread, orange, bulk, 480 caps per case, suitable for 48-format Cryo Tubes
<b>65-7573</b>	Screw Cap, 48-format, External Thread, red, bulk, 480 caps per case, suitable for 48-format Cryo Tubes
<b>65-7574</b>	Screw Cap, 48-format, External Thread, blue, bulk, 480 caps per case, suitable for 48-format Cryo Tube
<b>65-7575</b>	Screw Cap, 48-format, External Thread, green, bulk, 480 caps per case, suitable for 48-format Cryo Tubes
<b>65-7576</b>	Screw Cap, 48-format, External Thread, yellow, bulk, 480 caps per case, suitable for 48-format Cryo Tubes
<b>65-7577</b>	Screw Cap, 48-format, External Thread, purple, bulk, 480 caps per case, suitable for 48-format Cryo Tubes

## Tube Screw Caps

### 96 Format Internal Thread Screw Caps

<b>66-63100-Y1</b>	Screw Cap, 96-format, Internal Thread, white, bulk, 960 caps per case
<b>66-63100-Y2</b>	Screw Cap, 96-format, Internal Thread, red, bulk, 960 caps per case
<b>66-63100-Y3</b>	Screw Cap, 96-format, Internal Thread, yellow, bulk, 960 caps per case
<b>66-63100-Y4</b>	Screw Cap, 96-format, Internal Thread, blue, bulk, 960 caps per case
<b>66-63100-Y5</b>	Screw Cap, 96-format, Internal Thread, transparent blue, bulk, 960 caps per case
<b>66-63100-Y6</b>	Screw Cap, 96-format, Internal Thread, orange, bulk, 960 caps per case
<b>66-63100-Y8</b>	Screw Cap, 96-format, Internal Thread, green, bulk, 960 caps per case
<b>66-63100-Y10</b>	Screw Cap, 96-format, Internal Thread, amber, bulk, 960 caps per case
<b>66-63100-Y11</b>	Screw Cap, 96-format, Internal Thread, purple, bulk, 960 caps per case
<b>66-63100-Y12</b>	Screw Cap, 96-format, Internal Thread, natural, bulk, 960 caps per case
<b>66-63100-Y13</b>	Screw Cap, 96-format, Internal Thread, black, bulk, 960 caps per case

### 24 Format External Thread Screw Caps

<b>66-9401</b>	Screw Cap, 24-format, External Thread, orange, automation friendly, bulk, 240 caps per case, suitable for 2.2ml Tissue Tube, 5ml and 7.6ml PP Tubes
<b>66-9402</b>	Screw Cap, 24-format, External Thread, clear, automation friendly, bulk, 240 caps per case, suitable for 2.2ml Tissue Tube, 5ml and 7.6ml PP Tubes



# TPE Septum Caps



Developed to meet the needs of sample security, management and tracking in modern high-density storage applications, TPE septum caps are a disposable, thermo plastic elastomer (TPE) cap designed for optimal seal quality. Compatible with 96-format tubes, TPE caps are available for use with internal thread tubes and are manufactured from high-quality TPE, supplied as 96-cap mats or in bulk.



## Practical Design Based on Experience of Applications

- Piercable cap, for use with any 96-format internal thread tube
- Broad operating temperature range, suitable for use -80°C to +110°C
- Ideal solution for -20°C storage with occasional access
- Available in a choice of five colors to aid sample identification
- Suitable for Automatic and Semi-Automatic Cappers and De-cappers
- Natural color only recommended for automatic systems
- Supplied in 96-format back mats to facilitate automation

## Septum Cap Compatibility

- Suitable for 96-format Tri-coded Sample Storage Tubes, internal thread 0.65ml, 0.9ml
- Suitable for 96-format Dual-coded Tubes internal thread 0.3ml, 0.7ml, 0.9ml



## Ordering Information

### Internal Thread TPE Septum Seals

<b>65-73000</b>	TPE Septum Cap, natural, 96-format, on backing mat, 50 mats/4,800 caps per case, suitable for all Internal Thread Tubes
<b>65-73001</b>	TPE Septum Cap, blue, 96-format, on backing mat, 50 mats/4,800 caps per case, suitable for all Internal Thread Tubes
<b>65-73002</b>	TPE Septum Cap, green, 96-format, on backing mat, 50 mats/4,800 caps per case, suitable for all Internal Thread Tubes
<b>65-73003</b>	TPE Septum Cap, red, 96-format, on backing mat, 50 mats/4,800 caps per case, suitable for all Internal Thread Tubes
<b>65-73004</b>	TPE Septum Cap, yellow, 96-format, on backing mat, 50 mats/4,800 caps per case, suitable for all Internal Thread Tubes
<b>65-74000</b>	TPE Septum Cap, natural, 96-format, bulk, 960 caps per case, suitable for all Internal Thread Tubes



# SBS Cap Carriers

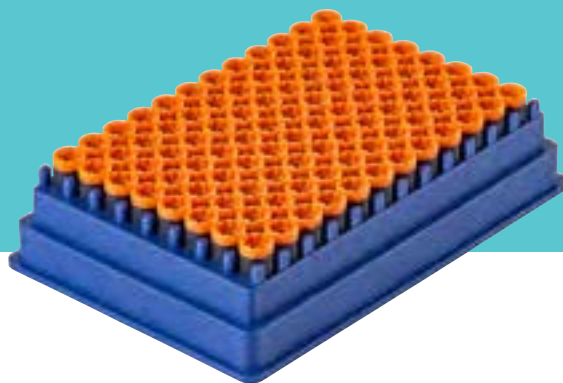

SBS-format screw cap carriers enable automated capping of 96-format sample storage tubes. Cap carriers are suitable for manual use or for use with Semi-Automated Screw Cap Decapper/Recapper, Single Channel systems and Automated Single Column Screw Cap Capper/Decapper systems.

Cap carriers are supplied in cases of 10 or 50, pre-filled with low-retention screw caps that can reduce sample loss (960 caps per case for 10 cap carriers, 4800 caps per case for 50 cap carriers).

## Improved Process Efficiency

- Cap Carriers enable uncapped tubes to be used immediately and then capped using an automated capping and de-capping system
- Leads to improved process efficiency and allows batch filling of tubes prior to capping
- When used manually, by transferring caps from the carrier to the tube using a single tube transfer device, the operation becomes faster and the risk of contamination is reduced as cap handling is eliminated

## Ordering Information

68-53111-50X	Cap Carrier (External and Internal Thread), empty, 96-format, SBS stackable, re-usable, 50 carriers per case, suitable for all 96-format External and Internal Thread Screw Cap Tubes
67-63111-10	Cap Carrier (Internal Thread), with orange caps, 96-format, SBS stackable, re-usable, 10 carriers/960 caps per case, suitable for all Internal Thread Screw Cap Tubes
67-63111-50	Cap Carrier (Internal Thread), with orange caps, 96-format, SBS stackable, re-usable, 50 carriers/4,800 caps per case, suitable for all Internal Thread Screw Cap Tubes
68-53111-10N	Cap Carrier (External Thread), with orange caps, 96-format, SBS stackable, re-usable, 10 carriers/960 caps per case, suitable for all 96-format External Thread Screw Cap Tubes
68-53111-50N	Cap Carrier (External Thread), with orange caps, 96-format, SBS stackable, re-usable, 50 carriers/4,800 caps per case, suitable for all 96-format External Thread Screw Cap Tubes
68-53111-10X	Cap Carrier (External Thread), empty, 96-format, SBS stackable, re-usable, 10 carriers per case, suitable for all 96-format External Thread Screw Cap Tubes
66-9951	Cap Carrier, 48-format, empty, SBS, for use with Semi-Automated and Automated Screw Cap Decapper series, 10 carriers per case
65-9801	Cap Carrier, 24-format, empty, SBS stackable, 10 carriers per case, suitable for 24-format Automation Friendly External Thread Screw Caps (part number 66-9401)



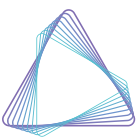

**AZENTA**  
LIFE SCIENCES

# Treatment Services

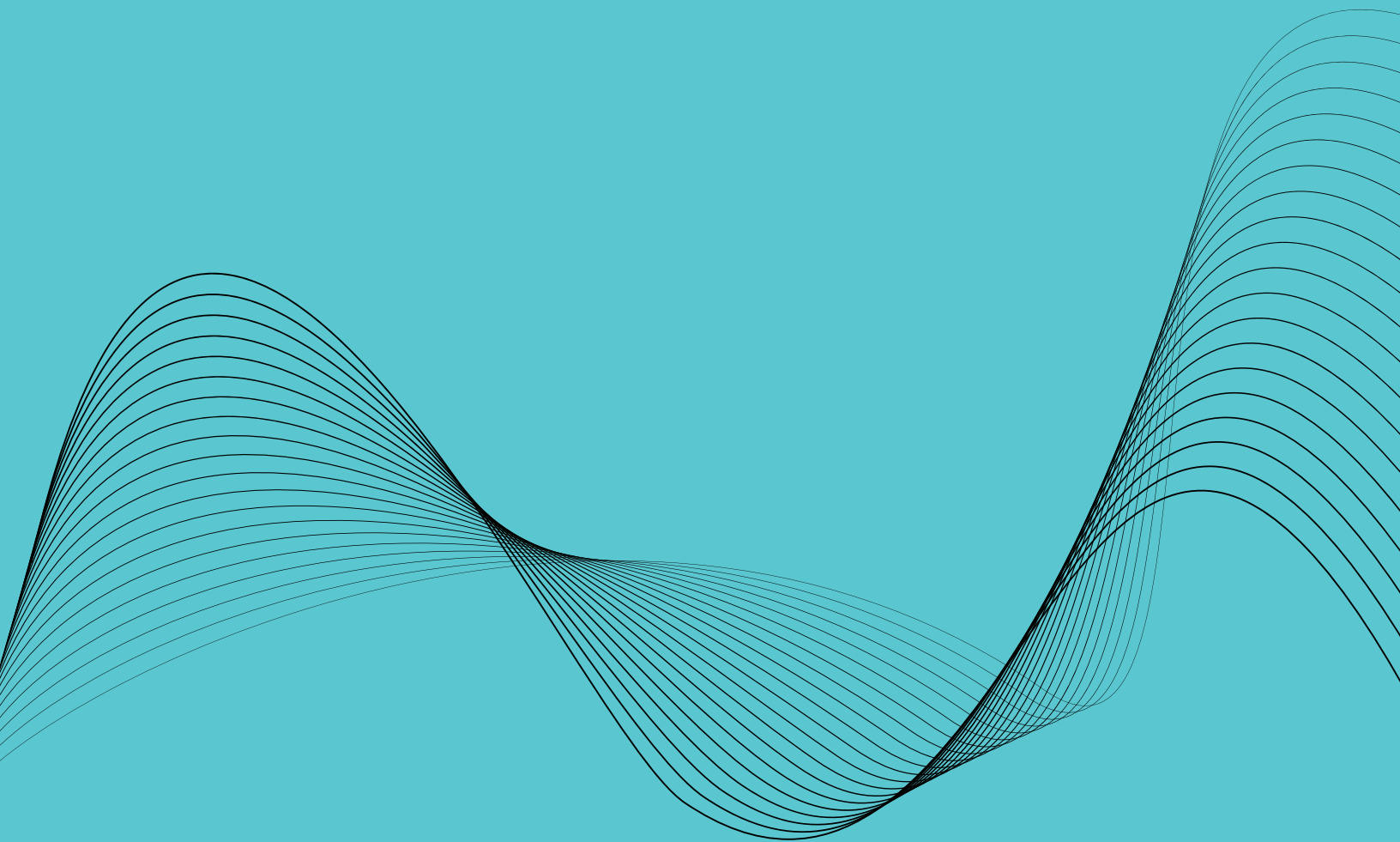

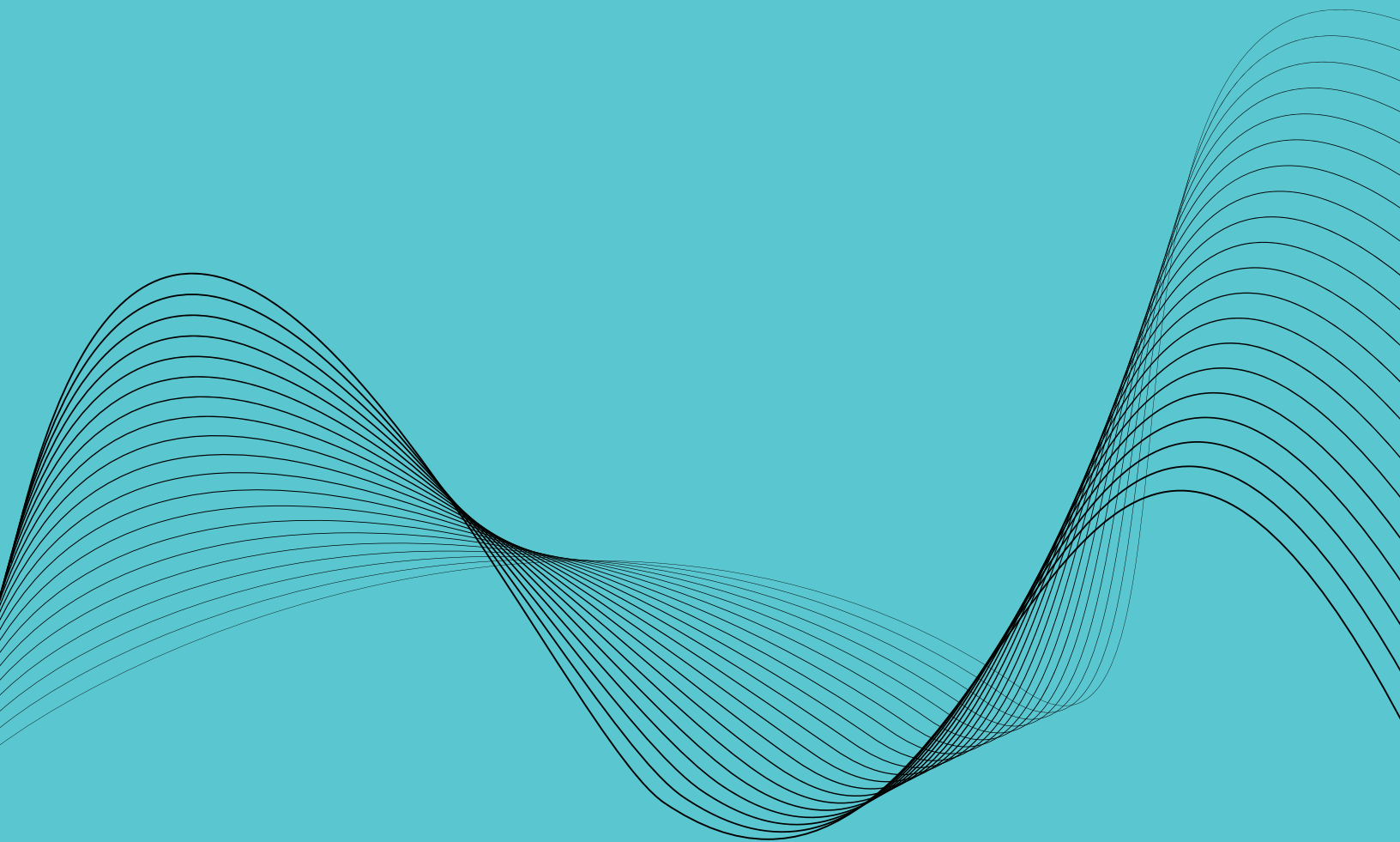

**AZENTA**  
LIFE SCIENCES

# Treatment Services

We understand how important it is to provide labware in a contamination-free condition and ideally suited for your research. This is why we provide alternative methods for treatment of products.

## Standard Product

Prevention is better than a cure, so we manufacture all sample storage consumables in an ISO class 8 clean-room environment. To gain access to this area, everyone must wear a gown, gloves, face mask, hair net and overshoes. In addition, they must pass through a double door with an “air-shower” designed to remove any particles. No material that could cause contamination is allowed in the clean-room.

The products are sterile at the point of molding, which takes place at temperatures that melt the resin – typically between 140°C to 150°C for copolymer and 165°C to 175°C for homopolymer.

From the injection molding machine, our consumables are processed and bagged in the clean-room. Only once they have left the clean-room are they placed in the transport box for shipment.

The efficacy of this process is tested periodically, which allows us to have a high degree of confidence that our products meet the standards outlined in the table below.

Contaminant	Testing Standard
Endotoxin (Pyrogen)	Product(s) are tested on a periodic basis and found to be below the acceptance level $\leq 0.05$ EU/ml
DNA/RNA DNase/RNase	Product(s) are free of contaminations based on 3rd party electrophoresis evaluation of degradation
Heavy Metals	No heavy metal is contained in any of our product(s) that meet CONEG requirements of 100 ppm/weight
Animal (TSE/BSE)	No product(s) are manufactured from or come into contact with, animal materials
PCR Inhibitors	Product(s) are PCR-inhibitor free

## Gamma Irradiation

Gamma irradiation is not guaranteed to destroy DNA contamination to the point where it doesn't amplify or interfere with subsequent analysis. Ensuring that no amplifiable DNA is present relies on (i) the manufacturing process and testing described above and (ii) fulfilling requirements for sensitive applications such as using Ethylene Oxide (EtO).

Gamma irradiation can negatively affect polypropylene, making it more brittle over time and increasing the binding characteristics of the plastic. For this reason, Azenta Life Sciences recommends that wherever possible, the standard product is relied on to deliver the contamination-free product required for research and long-term storage.

## Ethylene Oxide (EtO)

EtO is just as effective as gamma irradiation and in addition, it ensures there is no DNA that can be amplified to a level where there is risk of subsequent interference. Therefore, EtO is the treatment method of choice in critical areas such as forensics.



## Dual Ethylene Oxide (EtO2)

The newly published ISO 18385:2016 standard centers on minimizing the risk of human DNA contamination in consumable products used in collection, storage, or analysis of biological material for forensic DNA purposes. Dual EtO treatment is being recommended to further minimize the presence of PCR-amplifiable DNA

### Ordering Information

Contaminant	Standard Product	Gamma Irradiation	Ethylene Oxide	Dual Ethylene Oxide
<b>General Description</b>	Product is made in an ISO 8 (class 100K) clean room. Product is endotoxin (pyrogen), DNAase/RNAase, heavy metals & animal-free.	Ensures no viable micro-organisms but cannot guarantee destroyed DNA contamination. Affects PP, making it more brittle over time & increasing binding of plastic.	Effective at ensuring no DNA can be amplified to a level where there is any risk of interference.	Recommended for consumables used in the collection, storage, or analysis of biological material for forensic DNA.
<b>Recommended for standard use</b>	Yes	No	No	No
<b>Recommended for critical forensic applications (DNA amplification)</b>	No	No	Yes	Yes
<b>Modifies Polypropylene</b>	NO	Yes	No	No
<b>Product types</b>	All	Capped or uncapped tubes	Uncapped tubes only, bulk caps, cap carriers	Uncapped tubes only, bulk caps, cap carriers
<b>Packaging</b>	Bulk, case of 10 racks	Sleeve of five racks as standard – individually wrapped as option	Individually wrapped	Individually wrapped
<b>Min Quantity</b>	None	10 cases	25 cases	25 cases
<b>Part number</b>	N/A	-GS	-S	-DS
<b>Example part number</b>	<b>68-0703-02</b>	<b>68-0703-02-GS</b>	<b>68-0703-02-S</b>	<b>68-0703-02-DS</b>

# Recommended Temperature Range for Sample Storage Tubes



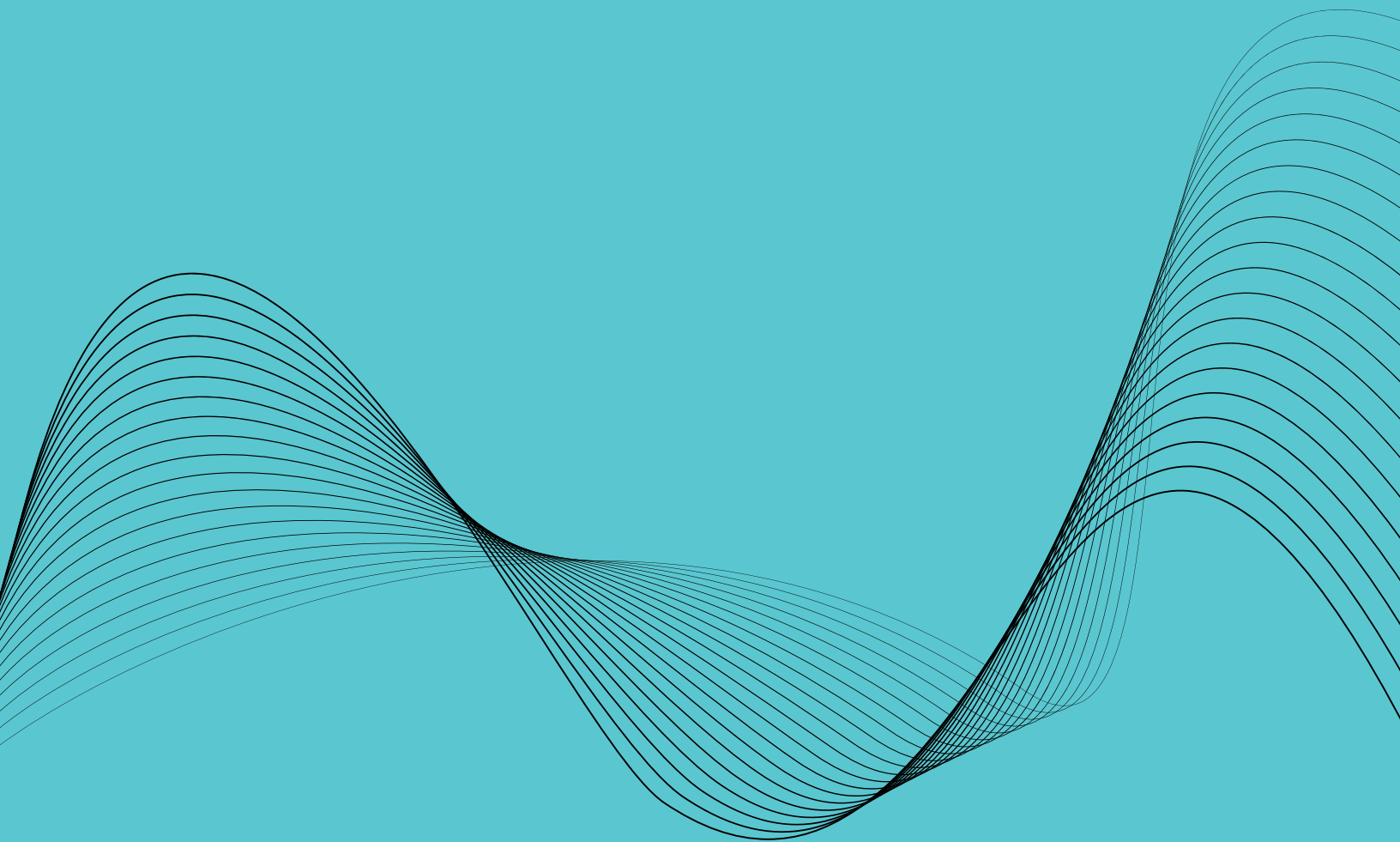

**AZENTA**  
LIFE SCIENCES

# Recommended Temperature Range for Sample Storage Tubes

Cryogenic storage at very cold temperatures is designed to provide an indefinite, if not nearly infinite, longevity to biological materials. By reducing sample temperatures to below the glass transition phase of water, all metabolic activity comes to a halt. Storage below this temperature therefore offers the most secure form of long term cryopreservation.

Storage in gas phase liquid nitrogen provides a convenient way of storing samples at temperatures below this transition temperature.

Screw cap storage tubes are designed for long term sample storage at cryogenic temperatures, including storage in the gas phase of liquid nitrogen.

Gas phase liquid nitrogen temperatures have been typically quoted as between  $-150^{\circ}\text{C}$  and  $-178^{\circ}\text{C}$ , depending on the location and the distance away from the liquid nitrogen reservoir surface. However, the latest generation of cryogenic storage systems are powered by liquid nitrogen in such a way to ensure a consistent temperature within the storage chamber, and can be as low as  $-195^{\circ}\text{C}$ .

All screw cap storage tubes are fully compatible with this storage temperature and can be safely used for long term storage in this environment. However, immersion in liquid nitrogen is not recommended for two reasons:

1. Liquid nitrogen is extremely pervasive.

If a tube cap is not completely and correctly tightened nitrogen may seep inside the tube. When the tube is then removed from storage this liquid nitrogen will instantly boil, expanding to over 700 times its liquid volume. This creates a significant risk of explosion and/or biohazard risk from aerosols.

2. Many researchers have noted that immersion in liquid nitrogen carries with it a significant risk of cross contamination from bacteria, viruses and DNA that can be present within the liquid nitrogen.

Therefore, if required, snap-freezing is best achieved by immersing the tube in liquid nitrogen to a depth that avoids the nitrogen coming into direct contact with the tube cap.

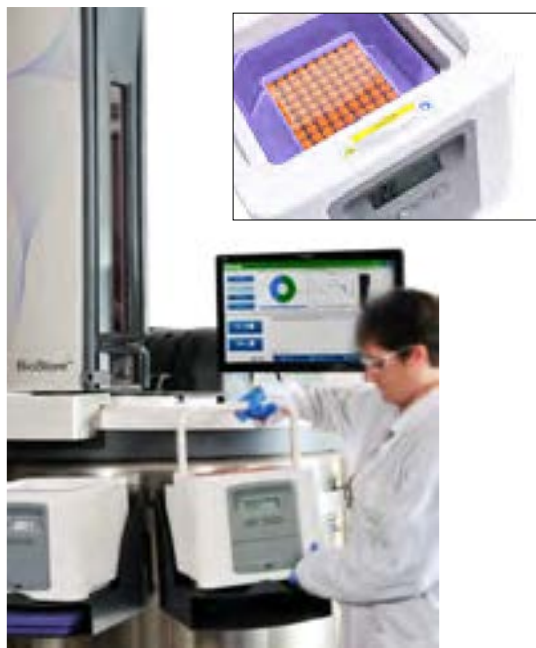

*BioStore™ with CryoPod™ Carrier*



*BioStore™ Automated Cryogenic Storage Solution*



# How Safe Are Your Samples? - Leachables and Extractables, Working Volume and Pressure Testing

## Part I: Evaluation of External Thread Tubes for Potential Leachable Compounds

Most plastics are supplied pyrogen- and DNase/RNase-free, it is generally accepted that this guarantees product integrity. Few researchers ever consider that despite these apparent guarantees, plastic ware can still provide a potential source of error. Evidence shows that bioactive compounds can diffuse into solutions that come into contact with the surface of the plastic. These compounds, typically referred to as “leachables” or “extractables”, are used during the manufacturing process to improve product stability and durability.

The aim of this evaluation was to determine if “extractables” could be detected in solvent solutions stored in Azenta external thread tubes and to compare the performance against competitor tubes.

## Part II: Working Volume

Knowledge of the working volume is a key criterion to consider when selecting the most appropriate tube and, is dependent on a range of factors including: Fill volume of the tube; Accuracy of the volume dispensed; Freezing conditions; Thawing conditions; Cap selected; Burst pressure of the cap.

Manufacturers of sample storage tubes specify the size of tubes in a variety of ways, but rarely state the sample type or storage conditions required to achieve the volumes stated. This can lead to catastrophic results if the working volume of the tube is exceeded.

## Part III: Sample Integrity Through Secure Capping

When using sample tubes, secure capping is paramount to protect sample integrity during the storage and handling process for a range of applications. These applications could include; Biobanking, Compound Management, Cell Therapy, Benchtop Research or applied industry. Two major hazards that can be mitigated through safe and secure sample tube capping are Evaporation and Cross contamination.



White Papers Available



**AZENTA**  
LIFE SCIENCES

# Code Reading Systems



# Single Tube Reader

The tube reader is high-performance, easy to use and portable with the dual capability of decoding any 2D datamatrix coded tube and reading any tube or rack carrying a 1D linear barcode.

Given the variety of 2D-coded tubes on the market, the reader is designed and developed with broad compatibility in mind and can read any 2D-coded sample tube currently on the market, not only those supplied by Azenta.

This USB single tube reader provides instant “plug and play” decoding of all 2D-coded tubes and 1D-barcode tubes and racks and is supplied with a 5-year warranty.



Single Tube Reader

## Key Features

### Compatible with all 2D-Coded Tubes

- Single tube reader is compatible with all Azenta tubes as well as any 2D datamatrix coded tubes, including those supplied by Greiner, Matrix, Nunc, LVL and Micronic
- Any tube size can be read. Will quickly scan tubes in 24, 48, 96, 240 and 384-well rack formats, as well as larger capacity tubes including glass compound storage tubes, cryo tubes and biological sample tubes

### Instant 1D and 2D-Code Reading

- Takes less than one second to scan any 2D-coded tube and display the result
- The tube ID is displayed instantly on the computer screen for identification or sample entry, or the application can be run in the background
- The large scanning window and superior decoding technology means the Single Tube Reader can quickly and easily decode 1D barcodes on racks and tubes

### Error-Proof Barcode Reading

- Blue LED target lights are emitted so that positioning the barcode for scanning is error proof, even when the user is wearing gloves
- Automatically scans the code (1D or 2D) and confirms a “good read”
- Direct Data Export to Any Application
- The keyboard wedge allows you to enter the results into any application
- Simply place the cursor where the data is to be entered before scanning the tube. The data will instantly be displayed wherever the cursor is positioned
- Will insert tube data into any application, such as Excel, Notepad, etc.



## Single Tube Reader

### Fast Set Up

- No need to calibrate, no drivers or software to install before scanning your first 1D or 2D-code
- USB simply starts working when plugged into a PC or laptop, no external power supply is required due to USB connectivity

### USB Single Tube Reader



<b>Code formats read</b>	Datamatrix, ISO 16022, square and rectangular format, ECC200, 0 to 20 grid sizes, white on black, black on white, numeric, alpha numeric and 1D linear barcodes
<b>Sensor type</b>	Sensor CMOS 1.2 Megapixel (1280 x 960) gray scale
<b>Light source</b>	Red LED with blue targeting LED
<b>Read time</b>	< 1 second per tube or rack, either 1D or 2D
<b>Ambient operating temperature</b>	-20°C to 55°C
<b>Tube compatibility</b>	All tubes in 24, 48, 96, 240 and 384-formats Glass compound storage tubes, cryo tubes, biological sample tubes
<b>Rack compatibility</b>	Linear barcode types: Codabar, Code 11, Code 32, Code 39, Code 93, Code 128
<b>Dimensions</b>	38mm (H) x 59mm (W) x 150mm (D)
<b>Operating humidity</b>	5% to 95% (non condensing)
<b>Power requirements</b>	5vdc (mA): typical = <200mA idle = <90mA
<b>User interface</b>	USB 2.0 HID keyboard
<b>Operating system(s)</b>	Windows XP, Windows Vista, Windows 7, Windows 8, Windows 10, Windows CE Mac O SX and Linux

## Ordering Information

**FLX-20-1003**

**Single Tube Reader USB "Plug And Play"**, with large window for all 2D Datamatrix labeled tubes and 1D Linear barcodes, hardware decoding with USB Keyboard wedge



**AZENTA**  
LIFE SCIENCES



# Scanner-Based Reader



Developed specifically for integration, the Scanner-Based Reader offers fast identification of SBS-format racked, 2D-coded sample storage tubes, without the need to remove tubes from racks. The backbone of many sample storage and tracking systems, this scanner based system is ideal for applications including biobanks, compound libraries and other high-throughput storage environments

- Compact, bench-top whole SBS rack scanner
- Integration friendly
- Small-footprint scanner-based solution
- No decoding attempt for empty tube position
- Given the variety of 2D-coded tubes on the market, this Scanner Based Reader is designed and developed with broad compatibility in mind, including 2D-coded tubes from alternative manufacturers, not only Azenta. Designed and developed entirely with the end user in mind, the Scanner-Based Reader offers fast identification of SBS-format racked, 2D-coded sample storage tubes, without the need to remove tubes from racks.
- Scanner-Based Reader systems offer the very best optical quality barcode scanning for 2D and 1D barcoded tubes within a rapid whole-rack scanner format with a small footprint. The system is based on scanning technology and forms the backbone of many sample storage and tracking systems, for applications including biobanks, compound libraries and other high-throughput storage environments
- The Scanner-Based Reader is supplied with a 5-year warranty



## Key Features

### Compatibility

- Compatible with all Azenta 2D datamatrix coded tubes, as well as with tubes supplied by other manufacturers
- Suitable for use with 48 and 96 SBS-format racks

### Integration Friendly

- Solution for rapid reading and integration
- Includes single position USB 1D linear barcode module for reading linear rack barcodes

### “No Tube” Feature Eliminates Errors

- Able to discriminate between a tube with a code that cannot be decoded, and an empty rack position
- Will not decode empty tube positions, so data files are kept clean
- Decoding speed is optimized as wasted data entry is eliminated.



## Scanner-Based Reader

### Scanner-Based Reader



<b>Code formats read</b>	datamatrix, ISO 16022, square and rectangular format, ECC200, 0 to 20 grid sizes, white on black, black on white, numeric, alpha numeric, Option: 1D linear barcodes
<b>Sensor type</b>	Color Contact Image Sensor (CMOS CIS)
<b>Light source</b>	R, G, B LED (variable light source)
<b>Read time</b>	4 to 5 seconds total scan and decode time
<b>Ambient operating temperature</b>	5°C to 55°C
<b>Tube compatibility</b>	Most tubes in 48 and 96 format SBS racks
<b>Dimensions</b>	51mm (H) x 156mm (W) x 256mm (D)
<b>Operating humidity</b>	10% to 90% (non condensing)
<b>Power requirements</b>	USB and AC 100 to 240V
<b>User interface</b>	Azenta GUI, including Windows TCP/IP, ODBC
<b>Operating system(s)</b>	Windows 7, Windows 8, Windows 10

## Ordering Information

<b>20-2101-A</b>	<b>Scanner-Based Reader</b> , includes linear barcode reader (70-2010), small-footprint scanner-based solution for rapid reading and integration
<b>70-2010</b>	<b>Single Position USB Linear Barcode Reader</b> , for Scanner-Based Reader. 1 per case

# Camera-Based Full Rack Readers

The Camera-Based range of compact whole rack 2D & 1D code readers offer fast identification of racked, 2D-coded sample storage tubes, without the need to remove tubes from racks.

Using advanced camera-based imaging systems, Camera-Based Full Rack Readers are ideal for more challenging applications and environments, such as integrating into robotic systems, or when speed and size of reader are important.

Camera-Based readers form the backbone of many sample storage and tracking systems, for applications including biobanks, compound libraries and other high-throughput storage environments.

An integrated multi-position Linear Barcode Reader is available for the simultaneous reading of rack linear 1D barcodes.

## Key Features of the Camera-Based Reader Range

### Flexible Applications through Advanced Design

- Using advanced camera-based systems, whole rack readers are ideal for more challenging applications, such as integration into robotic systems, cold store and low temperature environments and where speed and small footprint are important

### Automation and Robotics Friendly

- All Camera-Based rack readers have a gripper cutout section around the scan window to enable easy robotic handling of shallow racks
- The Camera-Based Reader for SBS Racks has a small footprint, barely larger than the SBS rack itself, aiding greater compatibility with automated systems including liquid handling

### Easy System Integration with Decoding Software

- Camera-Based Full Rack Barcode Reader systems used in conjunction with decoding software offer the most advanced data export options available
- Easy integration with database sample tracking and LIMS systems
- Compatible with multiple export templates including csv and pdf, with powerful design and formatting capabilities to create customized reports



*Camera-Based Reader for SBS Racks*



*Camera Based Reader for Acoustic Tubes*



*Camera-Based Reader for SBS Racks and Cryo Boxes*

## Camera-Based Full Rack Readers

### Additional Sample Security

- Storage tube racks can be supplied with the option of carrying a unique 2D-code identifier
- All Camera-Based Readers for SBS Racks are capable of reading both tube and rack 2D-codes simultaneously, to provide automatic rack orientation and greater sample security

### Linear 1D Barcode Reader (optional)

- Integrated multi-position 1D linear barcode reader helps to simplify robotic integration, is ideal for decoding more challenging (non-Azenta) linear barcodes and provides rack orientation

### Stored Rack Profiles

- Custom rack profiles can be set up for the regular use of routine, custom rack profiles, such as empty rows or control tubes in specific positions, saving set-up time
- Seamless Changing of Rack Format
- Using either built-in, or customized rack profiles, decoding software will automatically determine which rack type is being read
- Switch between 24, 48, 96, 240 and 384-format racks without making any changes to Camera-Based readers or decoding software



### “No Tube” Feature Eliminates Errors

- Camera-Based Readers for SBS Racks are able to discriminate between a tube with a code that cannot be decoded, and an empty rack position
- The reader will not attempt to decode empty tube positions, so data files are kept clean
- Reading speed is optimized as wasted data entry is eliminated

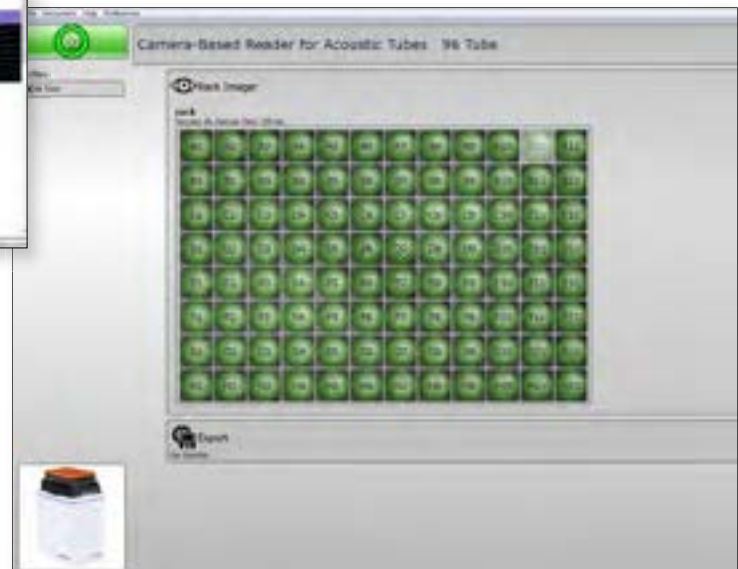

### Camera-Based Reader for SBS Racks

Providing even greater clarity, the Camera-Based range of compact whole rack 2D & 1D barcode readers offers fast identification of racked, 2D-coded sample storage tubes, without the need to remove tubes from racks.

Using high definition, camera based imaging systems, Camera-Based whole rack readers are ideal for more challenging applications and environments, such as integrating into robotic systems, cold environments or when speed and size of reader are important.

#### Features & Benefits:

- Compatibility – Use with any 2D-coded tubes in SBS format rack
- Footprint – Small footprint for integration
- Speed – Decode a full rack of tubes in less than 1 second
- High Definition – Reliably decode a variety of tubes
- Avoid Waste – “No tube” feature ensures wasted data entries are avoided

- Integration – Automation friendly design
- Linear Barcode Reading – Available with integrated multi-position linear barcode reader

#### Available in 3 models:

- Camera-Based Reader for SBS Racks
- Camera Based Reader for Acoustic Tubes
- Camera-Based Reader for SBS Racks and Cryo Boxes



Integration Friendly



Compatible with FreezerPro®

#### Camera-Based Reader for SBS Racks



Part Number	<b>20-4018</b>
Dimension (W x L x H)	97mm x137mm x 160mm
Weight	1000g
Camera Resolution	18 MegaPixel
Power supply	Powered by USB
Communication	USB 3.1
Linear Barcode Reader	Optional (70-4012) – Plug directly into PC
Decodable Formats	2D Datamatrix, QR Codes, ISO 16022, Square and Rectangular Format, ECC 200, 0 - 20 grid sizes, White on Black and Black on White, Numeric and Alphanumeric
Tube Formats	Almost all tubes in SBS format rack. Either 24, 48, 96, 240 or 384-formats.
Total Read Time	<1 second
Operating Systems	Windows 7, Windows 8, Windows 10

### Ordering Information

<b>20-4018</b>	<b>Camera-Based Reader for SBS Racks</b> , Whole rack reader for racks of 2D labeled tubes; small-footprint single camera based solution for very rapid reading and ideal for integration, USB 3.1 cable
<b>70-4012</b>	<b>Multiple Position Linear Barcode Adaptor</b> , including USB Opticon Barcode Reader for Camera-Based Reader for SBS Racks (20-4018)



## Camera Based Reader for Acoustic Tubes



<b>Part Number</b>	<b>20-4013</b>
<b>Dimension (W x L x H)</b>	97mm x137mm x 160mm
<b>Weight</b>	1000g
<b>Camera Resolution</b>	18 MegaPixel
<b>Power supply</b>	Powered by USB
<b>Communication</b>	USB 3.1
<b>Linear Barcode Reader</b>	Optional (70-4012) – Plug directly into PC
<b>Decodable Formats</b>	2D Datamatrix, Camera Based Reader for Acoustic Tubes 2D4 Codes, QR Codes, ISO 16022, Square and Rectangular Format, ECC 200, 0 - 20 grid sizes, White on Black and Black on White, Numeric and Alphanumeric
<b>Tube Formats</b>	Almost all tubes in SBS format rack. Either 24, 48, 96, 240 or 384-formats.
<b>Total Read Time</b>	<1 second
<b>Operating Systems</b>	Windows 7, Windows 8, Windows 10

## Ordering Information

<b>20-4013</b>	<b>Camera Based Reader for Acoustic Tubes, Whole rack reader for racks of 2D labeled tubes</b> , including Acoustic Sample Tube – Echo® Qualified Consumable; small-footprint single camera based solution for very rapid reading and ideal for integration, USB 3.1 cable
<b>70-4012</b>	<b>Multiple Position Linear Barcode Adaptor</b> , including USB Opticon Barcode Reader for Camera-Based Reader for SBS Racks (20-4018) and Camera Based Reader for Acoustic Tubes (20-4013)

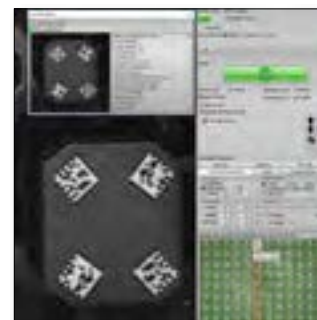
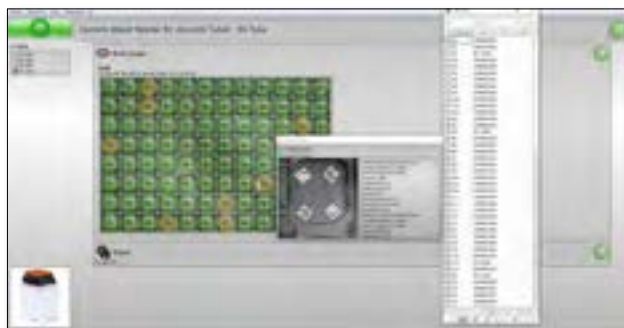

## Camera-Based Reader for SBS Racks and Cryo Boxes



<b>Part Number</b>	<b>20-4016</b>
<b>Dimension (W x L x H)</b>	147mm x147mm x 224mm
<b>Weight</b>	1350g
<b>Camera Resolution</b>	18 MegaPixel
<b>Power supply</b>	Powered by USB
<b>Communication</b>	USB 3.1
<b>Linear Barcode Reader</b>	Optional (70-4013) – Plug directly into PC
<b>Decodable Formats</b>	2D Datamatrix, QR Codes, ISO 16022, Square and Rectangular Format, ECC 200, 0 - 20 grid sizes, White on Black and Black on White, Numeric and Alphanumeric
<b>Tube Formats</b>	Almost all tubes in SBS format rack and Freeze Boxes. Either 9x9, 10x10, 13x13, 14x14, 24, 48, 96, 240 or 384-formats.
<b>Total Read Time</b>	<1 second
<b>Operating Systems</b>	Windows 7, Windows 8, Windows 10

## Ordering Information

<b>20-4016</b>	<b>Camera-Based Reader for SBS Racks and Cryo Boxes</b> , Whole rack reader for 14x14, 10x10, 9x9, 7x7 5x5 Square Cryo Racks of 2D labeled tubes and 24, 48, 96, 240, 384 SBS-format racks; Single camera based solution for very rapid reading, with USB 3.1 cable
<b>70-4013</b>	<b>Multiple Position Linear Barcode Adaptor</b> , including USB Opticon Barcode Reader for Camera-Based Reader for SBS Racks and Cryo Boxes (20-4016)

# Decoding Software



Decoding Software is intuitive software, designed with the input of users, for decoding 1D and 2D-coded sample storage tubes and racks.

Rapidly and simultaneously decodes Azenta sample storage tubes as well as any 2D datamatrix coded tubes, including those supplied by Greiner, Matrix, Nunc and Micronic.

Decoding Software can automatically determine rack types with the Profile Auto Detection feature, and provides a secure audit trail of all decoding performed creating export files and customized reports in multiple formats including csv and pdf, as well as secure data export to an SQL database.

## Key Features

### Easy Set-up Saves Time

- Decoding Software is pre-configured for use with 24, 48, 96, 240 and 384-format SBS racks
- Simply place your rack on the sample storage tube reader and the Decoding Software will do the work
- Simple, automatic profile creation for any readable 2D-coded tubes at the push of a button
- Determines rack profile (24, 48, 96, 240 and 384), automatically decodes and saves your data

### Ultra-Fast Decoding

- Decoding Software takes only 3.1 milliseconds to decode a sample storage tube, using the Camera-Based Reader for SBS Racks
- Dual Decoding Engine, so both Azenta proprietary decoding and industry-standard decoding engines work simultaneously for additional power and speed
- With true Multi-Core optimization, our Decoding Software is designed for use with modern PCs. This parallel processing enables a rack of 96 2D-coded tubes to be imaged and decoded in less than one second

### Unique and Secure Audit Trail

- Decoding Software keeps a secure audit trail of all decoding performed
- To recreate any export files, change file format or make a backup copy, simply set the data range required and the Decoding Software will generate the export file as required

### Simple File Export to LIMS or Database

- The built-in generator will customize the export file so that it is compatible with any LIMS or database system (txt or CSV files)
- Alternatively, use the auto-generate function to create a file in standard export format
- Use the built-in database connector for secure transfer of scanned tube data to your corporate SQL database

### Creative Report Generation

- Design your own, customized MS Word template with images, logos and format
- Decoding Software can automatically use this template to create professional and elegant data reports for your internal and external customers

### Remote Use

- Decoding Software can be remotely controlled using a console or TCIP.

### Advanced Rack ID Functionality

- Decoding Software can perform both 2D and 1D rack decoding when used in conjunction with a Scanner-Based whole rack scanner with Linear Barcode Reader
- A manual input option is available if the rack scanner is unable to read a rack barcode, or if an independent linear barcode reader is to be used

### “No Tube” Feature

- Our decoding software is able to discriminate between a tube with a code that cannot be decoded and a rack position containing no tube, and will not attempt to decode empty tube positions
- Data files are kept clean as wasted data entry is avoided, resulting in a faster rack reader and better data

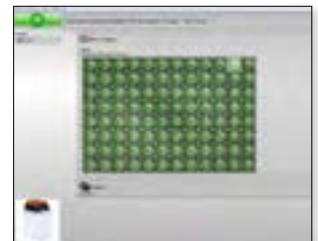

### Share Profiles and Data Files

- User profiles and export files can be shared between users on a single PC, and across a network, reducing set-up time and facilitating work streams







**AZENTA**  
LIFE SCIENCES

# Sample Tube Capping & Sealing Systems



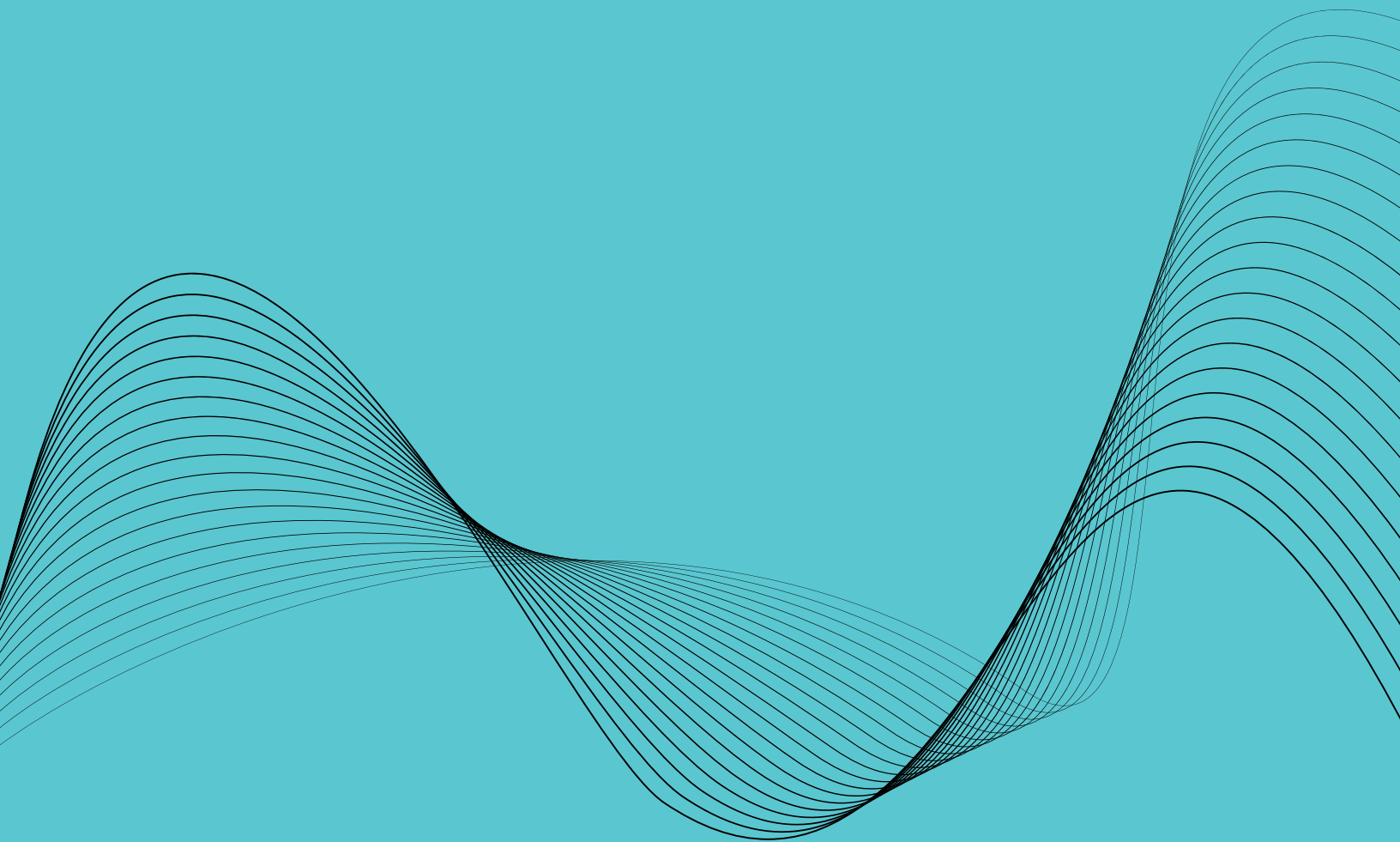

**AZENTA**  
LIFE SCIENCES

# Tube Capping and Sealing Systems

Azenta provides dependable manual, semi- and fully automated capping and de-capping solutions. The range incorporates products from single-tube manual de-cappers, through column cappers / de-cappers to fully automated and whole-rack solutions. All products are the result of over 15 years of continuous development and innovation, bringing the best solutions, with the most useful features, to the sample storage market.

## Semi-Automated Screw Cap Single Tube Decapper/Recapper

The Semi-Automated Screw Cap Single Tube Decapper/Recapper is the first-of-its-kind, single tube capper/de-capper in the industry. It provides a low-cost, reliable solution for managing the automated capping and de-capping of single and larger sized master sample tubes such as: centrifuge, cell culture and even glass tubes. Unlike many products on the market, where an engineering change of the gripper is required in order to tighten different tube types, the Semi-Automated Screw Cap Single Tube Decapper/Recapper allows you to manage a variety of tube types with a simple, interchangeable cap-driver system which can be changed in 5 seconds.

A flexible, faster and lower cost option for managing the capping/de-capping of larger sample tubes in the laboratory, this Semi-Automated Screw Cap Single Tube Decapper/Recapper is compatible with Azenta sample storage tubes, as well as a wide variety of tubes, with internal and external threads, from almost all major manufacturers.

Our Semi-Automated Screw Cap Single Tube Decapper/Recapper is designed to improve productivity while reducing the risk of repetitive strain injury.



## Key Features

- Fast and consistent single tube capping/decapping
- Perfect for automating the handling of larger sized master sample tubes such as: centrifuge, cell culture or even glass tubes
- Interchangeable cap driver kit for any tube format (9mm-40mm)
- Change the cap driver in 5 seconds
- Easy, single button, multi-torque control
- Suitable for use inside a laminar flow cabinet
- Low cost, automated solution
- Please contact us to discuss your specific tube requirements

### Automation for Fast and Consistent Capping Performance

- The same torque is applied to each cap, according to tube manufacturer specification, in order to ensure a consistent seal quality
- Automation reduces sample handling time, increasing sample throughput and workflow
- Screw caps can be held within the Semi-Automated Screw Cap Single Tube Decapper/Recapper unit whilst the user fills, or accesses, the sample tube
- Caps can subsequently be re-applied to the same tubes, eliminating the risk of cross-contamination

### Broad Compatibility for Every Laboratory

- The Semi-Automated Screw Cap Single Tube Decapper/Recapper is compatible with sample storage tubes from almost every manufacturer, as long as the screw cap can be gripped with cap drivers and the cap has a diameter from 9mm up to 40mm
- By adjusting the tube pitch required for each tube manufacturer, the Semi-Automated Screw Cap Single Tube Decapper/Recapper ensures that caps are not cross threaded during the capping cycle

## Semi-Automated Screw Cap Single Tube Decapper/Recapper

### Multiple Torque Control and Interchangeable Cap Driver

- Quick, user-friendly, interchangeable cap driver
- Cap driver can be changed in less than 5 seconds
- Torque is adjusted to fit the majority of tubes, allowing users to determine the optimal setting for their tubes
- 3 different torque settings: Low, Medium and High
- Easy to Use

### Technical Specification

Dimensions	333(L) x 110(W) x 300(H) mm
Weight	6.0 kg
Power Requirements	AC 100 -240V, 50/60 Hz, 26W
Cycle Time De-cap	< 3 sec per tube
Cycle Time Cap	< 3 sec per tube
Compatibility	Standard sized tubes with screw cap (verify gripper list)

## Ordering Information

46-6001	Semi-Automated Screw Cap Decapper, 1-channel, with interchangeable cap drivers and multiple torque settings
---------	---

## Ordering Information - Grippers

46-6002-1	Gripper kit, TRP tube 50ml Cap (Fujifilm)
46-6002-2	Gripper kit, BD Falcon tube 50ml Cap
46-6002-3	Gripper kit, BD Greiner tube Cap
46-6002-4	Gripper kit, Sarstedt 0.5 & 1.5 & 2.0ml Cap
46-6002-5	Gripper kit, Azenia 6 & 10ml Automation-Friendly Cap
46-6002-6	Gripper kit, Corning 21mm Cap
46-6002-7	Gripper kit, Azenia 6.0 & 10ml External Cap
46-6002-8	Gripper kit, Azenia 4.0ml Glass Jacket Tube Cap
46-6002-9	Gripper kit, Ø 50mm Cap for glass container
46-6002-10	Gripper kit, Azenia / Greiner Ext & Sarstedt Internal Cap
46-6002-11	Gripper kit, Greiner/Corning 1.2ml – 5.0ml Cap
46-6002-12	Gripper kit, Fisher Custom Tube Cap dia. 16mm
46-6002-13	Gripper kit, Falcon 15mm dia. centrifuge tube
46-6002-14	Gripper kit, Azenia 96-format External & Internal Co-Molded Caps
46-6002-15	Gripper kit, Sarstedt 12ml screwcap tube (60.9922.937); dia. 16mm
46-6002-16	Gripper kit, 3.5ml 14mm dia. False Bottom MarketLab Tube (Inpeco tube, EXT)
46-6002-17	Gripper kit, Glass Vials, 4ml (dia. 15mm,length 48mm, GNF)
46-6002-18	Gripper kit, 50ml, green cap, dia. 35.8mm, customized tube for optimum processing



# Semi-Automated Handheld Screw Cap Decapper, 8-channel



The Semi-Automated Handheld Screw Cap Decapper, 8-channel provides users with a flexible solution for capping and de-capping 96 format screw caps for low-to-mid throughput environments, with easily interchangeable cartridges to switch between tube types. The 8-channel hand-held capper and de-capper offers consistent sealing at an affordable price.

## Key Features

### Designed with the User in Mind

- Lightweight, hand-held, semi-automatic single column-based capper and de-capper
- Compatible with 96-SBS rack format screw capped tubes
- Caps a single column in under 4 seconds; caps/de-caps a complete rack of 96 tubes in less than 90 seconds
- All caps are tightened to the same torque to create a secure seal
- Battery operation allows capping/de-capping for more than 40 complete racks
- Docking station for instrument placement/storage and charging also provides contamination-free handling of caps
- Single 'action' button operation to de-cap, re-cap and eject caps
- Option to eject caps onto cap carrier using second 'eject' button



### Flexibility for Ease of Use

- Designed to be used by both left and right-handed users
- Unit can be operated by battery charge or powered through AC plug in
- Easily transportable
- Interchangeable cartridges, easy to switch between cap types

Get in touch with your local representative to discuss your labware requirements with us.

## Ordering Information

46-9012

**Semi-Automated Handheld Screw Cap Decapper, 8-channel**, Includes decapper (46-9008), docking station (46-9001), set of power cables, operation manual, cartridges for Azenta Internal Thread (48-9013-01) and External Thread (48-9013-02) for 96-SBS format racks



**AZENTA**  
LIFE SCIENCES

# Semi-Automated Screw Cap Decapper/Recapper

The Semi-Automated Screw Cap Decapper/Recapper systems are compact, bench top units designed for efficient tube capping in labs with medium throughput. Offering the consistency of an automated de-capping system, but at much lower cost, the Semi-Automated Screw Cap Decapper/Recapper can cap a single column of tubes, from a cap carrier, in under 10 seconds and will cap, or de-cap, a complete rack of 96 tubes in under 2 minutes.

## Key Features

### Flexible Product Options to Suit a Range of Tube Types



*Semi-Automated Screw Cap  
Decapper, 4-channel*



*Semi-Automated Screw Cap  
Decapper, 6-channel*



*Semi-Automated Screw Cap  
Decapper, 8-channel*

- **4-channel capping and de-capping system** compatible with screw-capped tubes in 24-format SBS racks
- **6-channel capping and de-capping system** compatible with screw-capped tubes in 48-format SBS racks
- **8-channel capping and de-capping system** compatible with screw-capped tubes in 96-format SBS racks

Your choice of model can be configured for use with one of the following tube types:

- Azenta internal and external thread screw-capped tubes
- Thermo-Matrix internal thread screw-capped tubes
- Micronic internal and external thread screw-capped tubes
- Thermo-Nunc Bank-IT tubes
- LVL external thread screw capped tubes

Please contact your local representative for the latest list of supported tubes

### Fast and Consistent Sealing Performance

- Has a set-down position that allows the simple insertion of screw caps using an Azenta Cap Carrier
- Caps a single tube in under 10 seconds
- Caps or de-caps a complete rack of 96 tubes in less than 2 minutes
- Individually spring-loaded cap drivers mean easy and consistent capping
- All caps tightened to the same torque, delivering a secure seal and peace of mind
- Designed for ease of use by both left and right handed people



## Semi-Automated Screw Cap Decapper/Recapper

### Space Saving Design

With a small footprint, the semi-automated screw cap decapper/recapper fits easily onto the bench top and is easy to install in a laminar flow cabinet.

Weight: 6 kg, Dimensions: 310mm (w) x 345mm (l) x 345mm (h)

### Ordering Information

Semi-Automated Screw Cap Decapper, 8-channel for use with 96-format racked tubes	
46-6501	Semi-Automated Screw Cap Decapper, 8-channel, compatible with Azenta Life Sciences internal thread tubes, in 96-SBS format rack
46-6502	Semi-Automated Screw Cap Decapper, 8-channel, compatible with Azenta Life Sciences external thread tubes, in 96-SBS format rack
46-6601	Semi-Automated Screw Cap Decapper, 8-channel, compatible with Matrix and Thermo internal thread tubes, in 96-SBS format rack
46-6602	Semi-Automated Screw Cap Decapper, 8-channel, compatible with Micronic internal thread tubes, in 96-SBS format rack
46-6604	Semi-Automated Screw Cap Decapper, 8-channel, compatible with LVL external thread tubes, in 96-SBS format rack
46-6606	Semi-Automated Screw Cap Decapper, 8-channel, compatible with Micronic external thread tubes, in 96-SBS format rack
Semi-Automated Screw Cap Decapper, 6-channel for use with 48-format racked tube	
46-6511	Semi-Automated Screw Cap Decapper, 6-channel, compatible with Azenta Life Sciences external thread tubes, in 48-SBS format rack
46-6512	Semi-Automated Screw Cap Decapper, 6-channel, compatible with Azenta Life Sciences internal thread tubes, in 48-SBS format rack
46-6513	Semi-Automated Screw Cap Decapper, 6-channel, compatible with Nunc external thread tubes in Greiner racks, in 48-SBS format rack
46-6605	Semi-Automated Screw Cap Decapper, 6-channel, compatible with LVL external thread tubes, in 48-SBS format rack
Semi-Automated Screw Cap Decapper, 4-channel for use with 24-format racked tube	
46-6521	Semi-Automated Screw Cap Decapper, 4-channel, compatible with Azenta Life Sciences external thread tubes, in 24-SBS format rack





# IntelliXcap™

IntelliXcap™ is the next-generation capper and de-capper, engineered for increased throughput, ease of use and high system reliability, making the system ideal for any laboratory managing compound libraries or biological sample stores.

## Key Features

### Advanced Automation Means Increased Throughput

- IntelliXcap is extremely fast and works with multiple sample storage tube types from a range of tube manufacturers in 24, 48 and 96 format
- Capable of de-capping a complete rack of 96 tubes in as little as 20 seconds
- Automation and high speed reduces sample handling time, increasing sample throughput workflow
- Ideal for medium to high-throughput laboratories managing compound libraries, biobanks or other biological samples
- Specific model available with verification camera, designed for use with Azenta Life Sciences Acoustic Sample Tube – Echo Qualified Consumable

### Compact, Modular Design Means Ultimate Flexibility

- IntelliXcap features the unique, fully automated, interchangeable cartridge cap driver system
- Cartridges allow change between different pre-configured tube types in less than 2 minutes
- Simply by fitting the relevant cartridge, IntelliXcap is compatible with all Azenta sample storage tubes, as well as sample storage tubes from Thermo Matrix, Thermo Nunc, LVL and Micronic
- Cartridges are available for both internal and external thread screw-cap tubes
- Control is via a quick installation, easy-to-use touch panel
- Light Curtain System detects the height of tube rack on the stage reducing the risk of damage to tubes, samples or the instrument itself that could be caused by failed de-capping / capping or the use of incorrect consumables



*Capper & De-capper for 96, 48 and 24 format Screw Capped Tubes*



### Easy to Use, Easy to Integrate

- Quick installation, easy-to-use touch panels bring instant control
- Wide operating temperature range of 5°C to 40°C
- Electric torque control means less persistent wear on cap drivers
- Easily integrated, sample rack stage extension facilitates fully automated workflow integration

### Driver and Cap Compatibility

- We provide a wide range of custom made and off the shelf driver cartridges to accommodate your specific labware needs
- The modular design of IntelliXcap™ allows you to quickly and easily change the cap driver cartridge and seamlessly swap between tube types, making the instrument the ideal capper/de-capper for your automated high throughput workflows
- Due to its flexibility, with one IntelliXcap instrument you can cap, de-cap and re-cap both internal and external thread tubes
- Please contact us to discuss your specific tube requirements

### Weights and Dimensions

	Weight (kg)	Height (mm)	Width (mm)	Depth (mm)
IntelliXcap 96	26.80	320	256	468
IntelliXcap 48	28.74	386.2	256	464.4
IntelliXcap 24	27.96	386.2	256	464.4
IntelliXcap 96 Acoustic	27	316	256	634

### Ordering Information

<a href="#">46-8012</a>	IntelliXcap Automated Screw Cap Decapper, 96-format, compatible with validated sample storage tubes and cartridges
<a href="#">46-8011</a>	IntelliXcap Automated Screw Cap Decapper, 48-format, compatible with validated sample storage tubes and cartridges
<a href="#">46-8010</a>	IntelliXcap Automated Screw Cap Decapper, 24-format, compatible with validated sample storage tubes and cartridges
<a href="#">46-8014</a>	IntelliXcap Automated Screw Cap Decapper, Acoustic 96-format, compatible with validated sample storage tubes and cartridges including Echo Qualified Acoustic Tube
<a href="#">46-8112</a>	IntelliXcap Extended Stage Kit



# Semi-Automated Septum Cap Capper

Semi-Automated Septum Cap Capper for TPE septum cap sealing of sample tubes in 96-well SBS format.

Offering secure storage tube sealing, this Semi-Automated Septum Cap Capper helps preserve sample integrity and audit trails in biobanks, compound libraries and other high-throughput storage applications.

## Key Features

### Flexible Sealing Performance, Broad Compatibility

- Semi-Automated Septum Cap Capper suitable for use with all 96-format Azenta sample storage tubes with TPE Septum Caps, as well as Micronic tubes with TPE Capmats, Matrix Technologies tubes with Sepraseals and Abgene Sealing Mats
- Depth of capping action is adjustable with the use of spacer plates, which ensures effective and efficient capping of all tube types
- Semi-Automated Septum Cap Cappers can be used to seal either full, or partially-full, racks

### Fast and Easy to Use

- Cycle time for capping is 20-30 seconds, depending on tube type and on the spacer plate used
- Simply place a rack in the Semi-Automated Septum Cap Capper drawer, with a TPE septum cap mat fitted loosely on top and, if needed, a spacer plate (adapter). Push the drawer shut, and the capping action will start automatically. Once all caps have been inserted, the drawer will open automatically and the sealed rack of tubes can be removed



*Semi-Automated Septum Cap Capper*

### Additional TubeLock Functionality

- Using the Semi-Automated Septum Cap Capper in conjunction with Azenta racks featuring TubeLock enables automatic locking and unlocking of tubes within the rack
- Azenta racks with TubeLock are dual position, allowing tubes to be locked in place for added sample security during handling
- Individual sample tubes can be pushed downwards to lock and pulled upwards to unlock in the rack
- For a faster approach, the Semi-Automated Septum Cap Capper, with an adapter set, can be used to lock, or unlock, all tubes in a 96-format rack simultaneously

## Ordering Information

System	
<a href="#">46-2004-115V</a>	Semi-Automated Septum Cap Capper, 115V
<a href="#">46-2004-230V</a>	Semi-Automated Septum Cap Capper, 230V
Adapters	
<a href="#">42-1003</a>	Adapter for Azenta tube rack [A] C:2mm H:4mm - Included
<a href="#">6.09.661</a>	Adapter for Azenta tube rack [B] C:1.6mm H:14mm - Included
<a href="#">42-1001</a>	Adapter for Azenta tube rack [C] C:2mm H:21mm - Included
<a href="#">6.09.663</a>	Adapter for Azenta tube rack [D] C:0.4mm H:30mm - Optional
<a href="#">6.09.664</a>	Adapter for Azenta tube rack [E] C:0.4mm H:37mm - Optional



# Sample Tube Management Systems



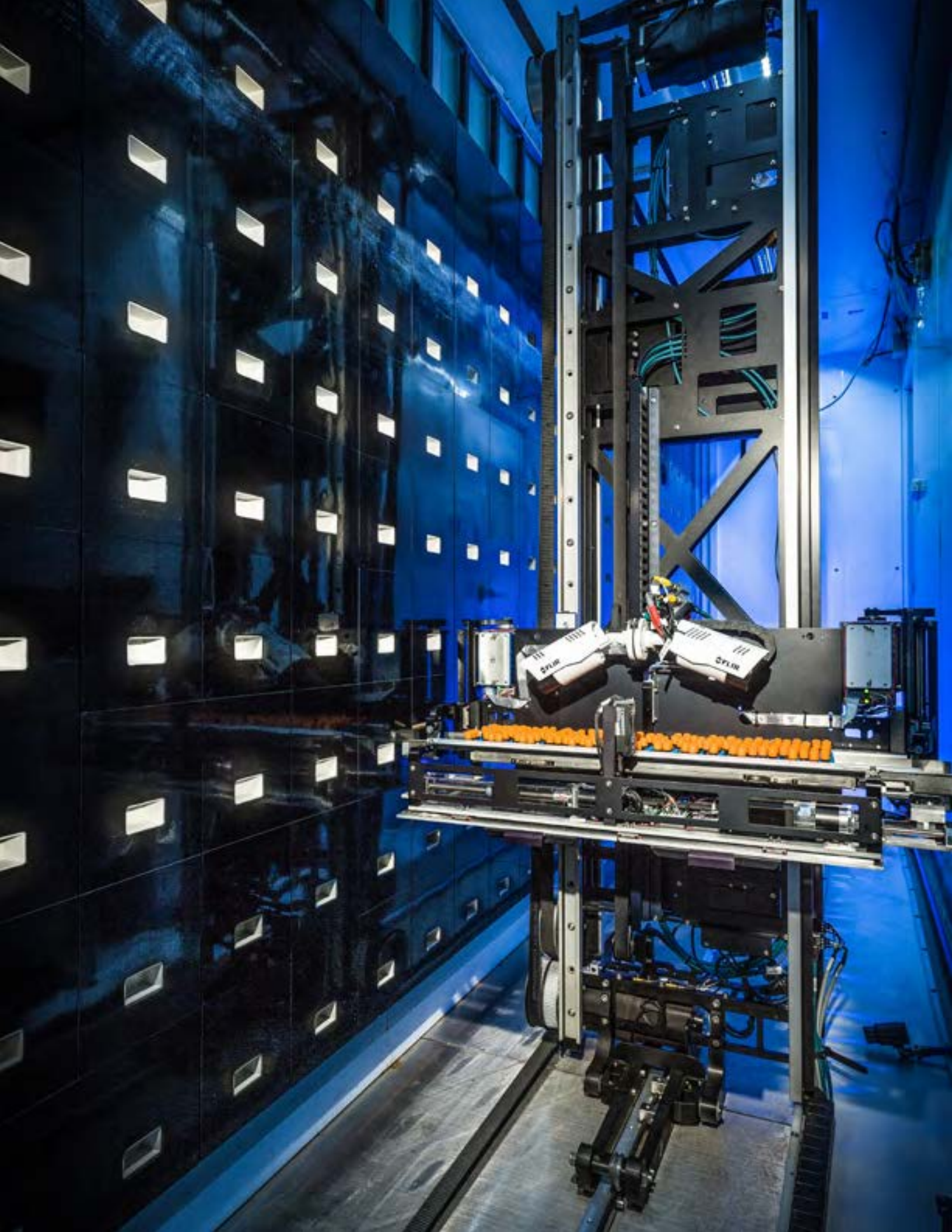

# Manual Tube Pickers and Manual Decappers

A manual device, with one-handed operation, the Manual Single Tube Picker incorporates an eject button enabling tube pick and place operations whilst avoiding contact between the hand and tube.

The Manual Single Tube Picker minimizes the risk of heat transfer to a frozen sample, as well as minimizing the risk of possible cross contamination.

Simple to use, even when wearing laboratory or cryogenic-handling gloves, the tube picker is available in either 96-rack or 48-rack format.



## Key Features

- Single-handed operation, soft grip handle
- Easy to use whilst wearing gloves
- All components that potentially come into contact with samples are made from temperature-resistant and chemically-resistant plastics
- Tubes can be selected from any position in the rack
- Removes the need for manual contact with tubes reducing the risk of heat transfer to frozen samples and cross contamination
- Ideal for use with Azena sample storage tubes and compatible with sample storage tubes from most other manufacturers

## Specifications

Manual Single Tube Picker, 96-format	length 150mm	diameter 17mm	weight 20g
Manual Single Tube Picker, 48-format	length 165mm	diameter 17mm	weight 23g

**Manual Decappers:** The ideal range of accessories for the manual removal of TPE caps and Screw caps.

Our TPE septum cap options comprise: A 1-way decapper for the individual removal of TPE caps and an 8-way decapper for the simultaneous removal of 8 TPE caps. For screw caps, we offer our Azena screw cap Capper/Decapper, designed specifically for external thread tubes.



## Ordering Information

10-5010	Manual Single Tube Picker, 96-format, 1 picker per case Suitable for Azena and most other manufacturers 96-format tubes
10-5020	Manual Single Tube Picker, 48-format, 1 picker per case Suitable for Azena and most other manufacturers 48-format Cryo Tubes
65-54000	Manual Decapper-1, for removal of 1 TPE cap at a time, 1 decapper per case
65-54001	Manual Decapper-8, for removal of 8 TPE caps at a time, 1 decapper per case
65-54004	Manual Screw Cap Capper/Decapper, 1 capper/decapper per case. Suitable for Azena 96-format External Thread tubes



# Automated Tube Labeling System

A highly specialized printer and applicator for the automatic application of individually printed labels on microtubes within SBS format racks.

- Automatic application of individually printed labels on microtubes within SBS format racks
- Thermal printing, labels 800 tubes per hour

## Key Features

- Uses thermal printing to label 800 tubes per hour
- Standard label sizes: 28 x 15mm or 28 x 12.5mm. Further labels sizes are also available
- Compatible with both capped and non-capped tubes
- An integrated PLC unit offers maximum control



## Specifications

Automated Tube Labeling System	
Interface	USB and RS232
Software	Windows XP, 7 & 10 compatible GUI
Print method	Thermal transfer. Able to print a variety of widely used barcodes and human readable text
Label size	Multiple label sizes available depending on tube size. These specially designed labels can withstand temperature as low as -40 °C with no loss of adherence
Media	Compatible with Azenta sample storage tubes, as well as sample storage tubes from Thermo Matrix, Thermo Nunc, Sarstedt and Micronic Operates on capped and uncapped tubes within a 24, 48 or 96 format SBS rack
Capacity	800 tubes/hour (approx)
Dimensions	L 690 x W 510 x H 520mm
Power	100-240 VAC
Air supply	6-8 bar
Weight	25Kg



### Ordering Information

Use these numbers to request a quote	
75-0001	Automated Tube Labeling System, printer and applicator for the Automated application of individually printed labels on sample storage tubes within an SBS format rack Base unit including 1 Gripper Kit - please state at time of ordering
75-0101	Automated Tube Labeling System Rack Tray, custom, 4x96 SBS racks
75-9001	Automated Tube Labeling System, for use with multiple tube formats, includes quick lock head for easy exchange
77-0006	Automated Tube Labeling System Database Software, optional software, required if using multiple tube setup
	Automated Tube Labeling System Gripper Kits. Please contact us for further information
Labels for Automated Tube Labeling System	
75-1001-A	Label 9mm x 32mm, 2000 labels per roll, White PetTop, suitable for -80°C - +150°C
75-1001-B	Label 9mm x 38mm, 2000 labels per roll, White PetTop, suitable for -80°C - +150°C
75-1001-C	Label 9mm x 42mm, 2000 labels per roll, White PetTop, suitable for -80°C - +150°C
75-1001-D	Label 13mm x 28mm, 2000 labels per roll, White PetTop, suitable for -80°C - +150°C
75-1001-E	Label 13mm x 35mm, 2000 labels per roll, White PetTop, suitable for -80°C - +150°C
75-1001-F	Label 13mm x 42mm, 2000 labels per roll, White PetTop, suitable for -80°C - +150°C
75-1001-G	Label 15mm x 35mm, 2000 labels per roll, White PetTop, suitable for -80°C - +150°C
75-1001-H	Label 15mm x 38mm, 2000 labels per roll, White PetTop, suitable for -80°C - +150°C
75-1001-I	Label 15mm x 42mm, 2000 labels per roll, White PetTop, suitable for -80°C - +150°C
75-1001-J	Label 15mm x 28mm, 2000 labels per roll, White PetTop, suitable for -80°C - +150°C
75-1013	Thermal Transfer Black Ribbon, 35mm x 450m
75-9900	Automated Tube Labeling System Customization for non-standard tube labels. Please provide 2 rolls from 2 different batches for testing and validation with instrument. (Azenta is not responsible for batch-to-batch variations in labels causing reliability issues with the instrument)



# Direct Tube Marker

Tube labels or stickers are no longer required for sample identification - Direct Tube Marker is designed to print text, 1D linear barcodes, 2D data matrix codes and / or graphics directly onto most polypropylene sample storage and general-purpose laboratory tubes. Using Thermal Pixel Printing technology, Direct Tube Marker prints directly onto the surface of tubes sized from 0.5ml to 50ml.

Clear and durable marking with consistently legible text and barcodes printed at high resolutions is easier and faster than marking by hand. Direct Tube Markers permanent printing is resistant to water, alcohols (methanol, ethanol, isopropanol), DMSO, haematoxylin, liquid nitrogen and mechanical abrasion.\*

Printed information is stable over a wide temperature range from -196°C to 100°C and markings do not transfer when tubes are manually handled.

The Direct Tube Marker delivery package contains tube adapters with hole diameters 8.5mm, 11.5mm and 12.7mm. These are compatible with most commonly-used tubes. Other adapters are available to order separately, please specify at time of ordering.



## Key Features

- Direct Tube Marker prints directly on the surface of plastic laboratory and sample storage tubes in seconds
- Most 0.5ml to 50ml tubes with a smooth surface can be printed
- Adjustable tube support platform allows printing on tubes without a lip or collar
- Tube profiles created in the Direct Tube Marker software can be saved for future reference and sample tracking
- Adjustable sled pivot point improves overall print quality for larger tubes and labels
- Wide range of adapters available for differing diameter tubes

### Flexible Label Printing to Suit Your Needs

- Tubes can be marked with any orientation
- Direct Tube Marker can print text, 1D linear barcodes, 2D datamatrix codes and graphic files (monochrome .bmp, .gif, .tiff) such as logos
- Several lines of text can be printed, such as: sample name, your name, date, time etc.
- All TrueType fonts available on the connected PC can be printed
- Font size and type will determine the maximum available printable content

### High-Quality and Durable Printing

- Thermal Pixel Printing technology produces clearer and more durable marking than marker pens
- Metallic blue, black and white ink ribbons are available for a range of colored tubes and colored contents
- Printing straight onto the tube surface is much easier than marking by hand or adhesive label
- Quick and easy to change ink ribbon
- Marking resistant to 70% ethanol, 70% isopropanol, >98% methanol, DMSO, pure haematoxylin, liquid nitrogen & mechanical abrasion\*
- Printing is temperature resistant from -196°C (liquid nitrogen) to 100°C
- 300m ink ribbon will mark up to 100,000 tubes\*\*
- Enables full integration within robotic automation systems
- Easy integration with SiLA compliant devices using SiLA driver
- Instrument reliability

\*ribbon chemical resistance dependent on ribbon type

\*\*dependent on size of label print



**AZENTA**  
LIFE SCIENCES

## Direct Tube Marker



### Specifications

Parameter	Value
Communication	USB port
Print Method	Thermal Pixel Printing
Label Detail	Print height: 6mm, Print width: 40mm, Any print orientation
Tube Compatibility	Most plastic laboratory tubes 0.5 to 50ml
Dimensions L x W x H	280mm x 270mm x122mm
Electrical	V in: AC 100-240V V out: DC 18V
Weight	4.8kg
Throughput	Up to 200 Plate Seal Removals per Hour

### Ordering Information

<b>4ti-0680-1</b>	Direct Tube Marker, includes: 3 x tube adapters (4ti-0681, 4ti-0683 and 4ti-0684)
<b>4ti-0681</b>	Direct Tube Marker Adapter, tube adapter for 1.5 ml/2 ml tubes
<b>4ti-0683</b>	Direct Tube Marker Adapter, tube adapter for 2D cluster tubes
<b>4ti-0684</b>	Direct Tube Marker Adapter, tube adapter for cryo tubes
<b>4ti-0685-1</b>	Direct Tube Marker Adapter, tube adapter for 2 ml screw cap tubes (10 mm diameter)
<b>4ti-0685-2</b>	Direct Tube Marker Adapter, tube adapter for 15 ml tubes
<b>4ti-0685-3</b>	Direct Tube Marker Adapter, tube adapter for 50 ml tubes
<b>4ti-0685-4</b>	Direct Tube Marker Adapter, tube adapter for Matrix tubes
<b>4ti-0685-5</b>	Direct Tube Marker Adapter, tube adapter for 0.2 ml tubes
<b>4ti-0686</b>	Direct Tube Marker Ribbon, metallic blue
<b>4ti-0688</b>	Direct Tube Marker Ribbon, white
<b>4ti-0689</b>	Direct Tube Marker Ribbon, black
<b>4ti-0689-1</b>	Direct Tube Marker Ribbon, black, universal



# Tube Auditor™



Tube Auditor™ is a fast, accurate and non-invasive device used to measure sample volume in microtubes. The instrument performs quick and easy Goods-In and Goods-Out QA checks to help ensure that your suppliers are providing what you ordered and that your customers are receiving what you promised. Tube Auditor gives confidence in sample quality (at both collection and output) and helps to reduce downstream costs and waste, which can arise from empty wells and precipitated samples

- High-speed measurement - accurate to better than +/- 10µl - minimizes downstream costs from the processing of empty plate wells
- Compatible with 96-SBS or 48-SBS format racks
- Precipitate detection - increases confidence in the concentration of delivered output samples
- Cap detection - helps avoid damage to liquid handling tips caused by failed de-cap operations
- No need to de-cap tubes - eliminates possibility of cross contamination
- Manual or remote operation - if integrated into an automated system, an OPC license is required to enable remote control
- Image storage and recall - allows audit trail and provides ability to re-assess or re-analyze the image
- Tube Auditor uses high-speed vision technology to measure sample volume and detect precipitate



## Specifications

Parameter	Tube Auditor
Volume measurement	✓
Cap detection	✓
Manual and remote operation	✓
User interface software	✓
Image capture and recall	Available with "Pro" version enabled only
Precipitate detection	Available with "Pro" version enabled only
Dimensions (L x W x H)	872 x 433 x 433mm (34.33 x 17.05 x 17.05in)
Weight	35kg (77lbs)
Electrical	110-240 VAC 50/60Hz
PC	Microsoft Windows 10
Output data format	CSV or XML(user configurable)

## Ordering Information

System	
96-0001	Tube Auditor, 96-format, for high-speed non-contact volume measurement
96-0002	Tube Auditor, 96-format, for high-speed non-contact volume measurement, with 2D tube reader
96-0003	Tube Auditor, 96-format, for high-speed non-contact volume measurement, with opc license
96-0004	Tube Auditor, 96-format, for high-speed non-contact volume measurement, with 2D tube reader and opc license
Tube Auditor compatible with 48-SBS racks	
98-0001	Tube Auditor, 48-format, for high-speed non-contact volume measurement
98-0002	Tube Auditor, 48-format, for high-speed non-contact volume measurement, with 2D tube reader
98-0003	Tube Auditor, 48-format, for high-speed non-contact volume measurement, with opc license
98-0004	Tube Auditor, 48-format, for high-speed non-contact volume measurement, with 2D tube reader and opc license
Software License for Pro version	
97-0001	Tube Auditor Precipitate Detection Software, used to activate the Precipitate Detection feature of Tube Auditor, provides a facility to save and recall audited tube images, suitable for Tube Auditor 48-format (part number 98-0001-98-0004) and Tube Auditor 96-format (part number 96-0001-96-0004), compatible with all existing Tube Auditor configurations

# FreezerPro® Sample Management System

The FreezerPro system is a scalable web-based sample inventory management system ideal for users managing hundreds of collections in all types of organizations ranging from lower throughput labs to central biorepositories with millions of records; delivers secure management of samples and sample information.

- Complete sample management
- Track samples in and out of freezers
- Reporting and data export/import (multiple formats)
- Live and smart search
- Full audit trails

Using cross-region servers and industry-defining storage technologies, the system is designed to keep samples in the right conditions and make retrieving them for study easier. We manage security through sample data encryption, both during sample transit and while they are at rest. FreezerPro is designed and developed as a web-based sample management system that provides access to sample information from anywhere in the world.

- **No IT Requirements Whatsoever** - By not requiring installation, individual labs within larger organizations gain more autonomy. Start-ups and other small labs can completely avoid all IT staffing and investment
- **Regulatory Liability Protection** - Remove nearly all liability concerns related to data security. Using FreezerPro Cloud negates expensive information security upgrades for individual labs
- **Lower Capital Expenditure** - With FreezerPro Cloud, the total cost of deployment is significantly lower, compared to other sample management software options. FreezerPro is a class-leading frozen sample management solution that is indispensable to any modern scientific or pharmaceutical laboratory
- **Deployed in Hours, Not Weeks** - FreezerPro systems automate more daily sample management operations than expensive software solutions
- **Makes Daily Lab Operations Easier** - FreezerPro Cloud records information for sample check in and out, aliquotting and inheritance, plus storage location data with only a few clicks or a drag of the mouse
- **Enhances Accuracy and Availability of Lab Information** - Advanced data mining, automatic data validity checks, hundreds of alert settings and embedded integration with Microsoft Excel are just a few of the tools users and admins have to ensure that data is input properly and is immediately accessible for analysis and reporting.



**AZENTA**  
LIFE SCIENCES

# Automated Sample Storage Solutions

In addition to our extensive range of consumables and instruments, Azenta Life Sciences is also the global leader in automated sample storage systems.

Our deep application experience and proven, highly reliable technology protects sample integrity and improves sample visibility to ensure the continuity of your sample management. From compound management and high-throughput screening, to biobank sample management, to storage of cellular products at cryogenic temperatures; Azenta provides flexible, modular solutions that offer the security and reliability to optimize our customers workflow. As the preferred storage partner to the world's top biotechnology companies, Azenta reduces risk and delivers industry-leading uptime that maximizes the return of your sample management investment.

Flexible automated storage technology that fits your applications allowing you to focus on delivering your research goals.

Transforming workflows and productivity to improve research timelines, our stores accommodate collections from fewer than 7,000 to up to 100 million samples, and are adaptable to meet future needs.

- **SampleStore Space Efficient** – Ambient to -20°C
- **BioStore Space Efficient** – -80°C
- **SampleStore** – Ambient to -20°C
- **BioStore** – -80°C
- **BioStore Automated Cryogenic Storage Solutions** – Desired temperature between -20°C and -150°C\*; -190°C vapor storage environment

*\*Temperature variation is +/- 6°C due to thermocouple variation and thermal loading*



*SampleStore  
Ambient to -20° C*

*BioStore Automated  
Cryogenic Storage  
Solutions -190° C*



*BioStore  
-80° C*



### Strata™ Control Software

Strata™ control software enables precise sample inventory management within the Azenta automated storage systems. Strata's intuitive, information rich interface makes automated storage flexible, easy and convenient.

- No special engineering expertise is required
- Efficiently processes and securely protects samples
- Sample data is accessible from any location using a laptop, tablet, or other web enabled devices
- Simplified integration with corporate IT and LIMS networks
- Intelligent diagnostics and error recovery ensure reliable performance

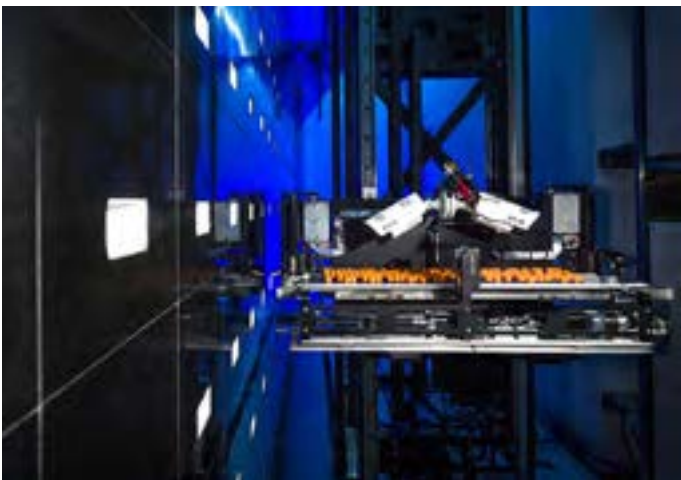
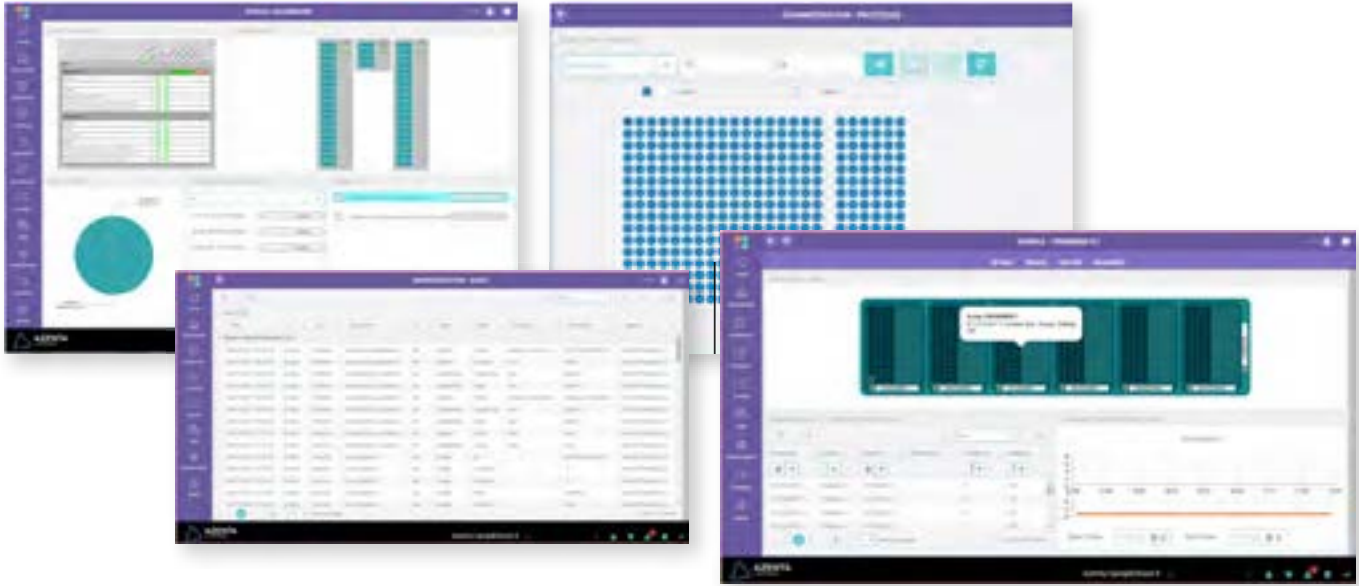

# CryoPod™ Carrier



Portable Liquid Nitrogen (LN2)-Based Cryogenic Transport.

CryoPod™ Carrier provides a safe, reliable and portable <math>-150^{\circ}\text{C}</math> cryogenic environment for the handling and transport of biological specimens for over 3 hours. The instrument displays and logs temperature, date and time, and features audible and visual alarms, and integrates into an optional automated filling station for hands-free replenishing of the LN2 charge in less than 15 minutes.

## Ensures operator safety

- Allows safe and quick transportation of cryogenic samples
- Hands-free auto-fill option

## Maintains sample cold chain integrity

- Temperature display with audible and visual alarms
- Temperature logging and retrieval

## Delivers reliable performance

- Over 3 hours <math>-150^{\circ}\text{C}</math>
- No direct sample contact with LN2

## Portable

- Compact footprint; only ~9 lbs
- Built-in handle and bottom finger grips



## Specifications

Hold Time	Over 3 hours <math>-150^{\circ}\text{C}</math> with lid closed
Capacity	One 2" cryobox, 2 SBS plates or some cassette sizes
Charge	Requires <math>< 3\text{L}</math> liquid nitrogen (LN2)
Alarm	Two settings with audible and visual signals
Lid	Magnetized foam lid for safer transport and insulation
Power	3 AA alkaline batteries (included)
Temperature Audit Trail	Downloadable temperature log data via USB port and CryoPod Data Log Software
Weight	4.1 kg (9 lbs) without LN2 5.9 kg (13 lbs) fully charged with 3L LN2 - no samples
External dimensions (L x W x H)	34.0 x 32.0 x 26.0 cm (13.4 x 12.6 x 10.2 in)
Cryogenic chamber basket dims (L x W x H)	17.4 x 18.8 x 7.8 cm (6.9 x 7.4 x 3.1 in)

## Ordering Information

243354-001	CryoPod™ Carrier, includes orange lid and manual fill kit
252888-002	CryoPod™ lid, green, optional
252888-001	CryoPod™ lid, orange, optional
252888-004	CryoPod™ lid, pink, optional
252888-003	CryoPod™ lid, grey, optional
252888-005	CryoPod™ lid, purple, optional
252885	CryoPod™ Manual Fill Kit
252886	CryoPod™ LN2 Absorbent Pads, 4pc, 2/pk

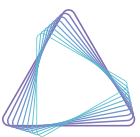

**AZENTA**  
LIFE SCIENCES



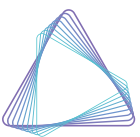
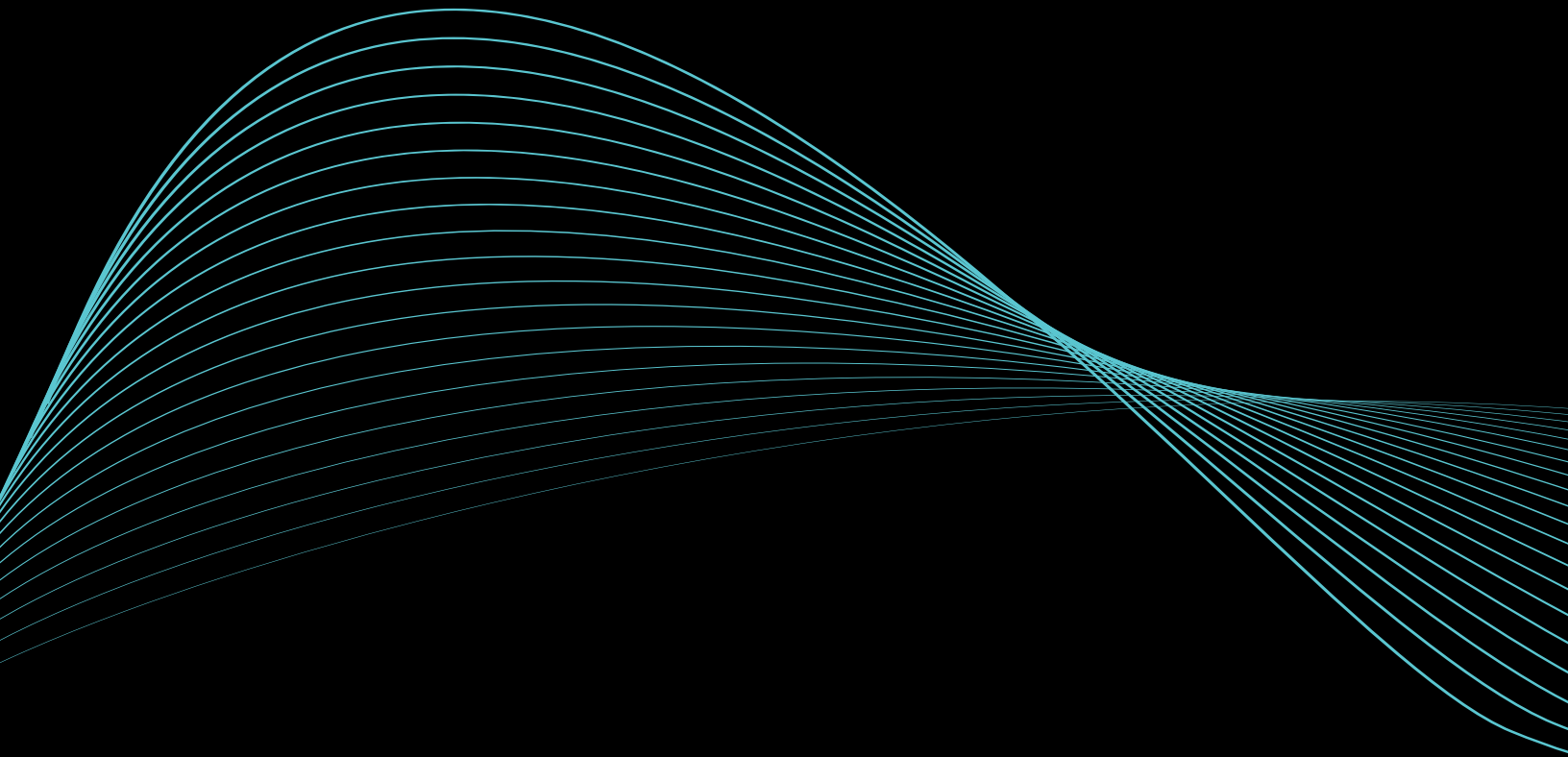

**AZENTA**  
LIFE SCIENCES

# PCR/Microplate Consumables and Instruments

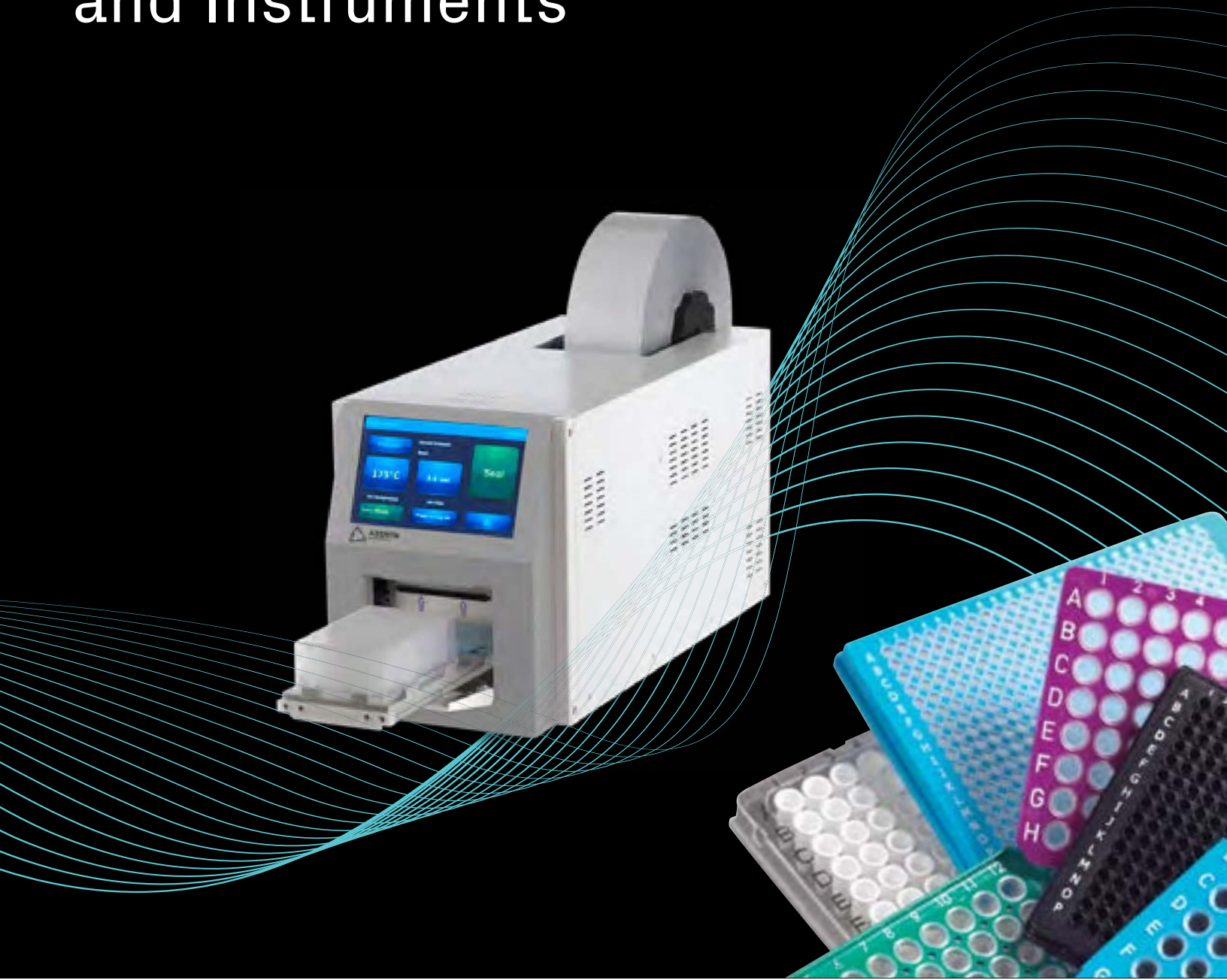

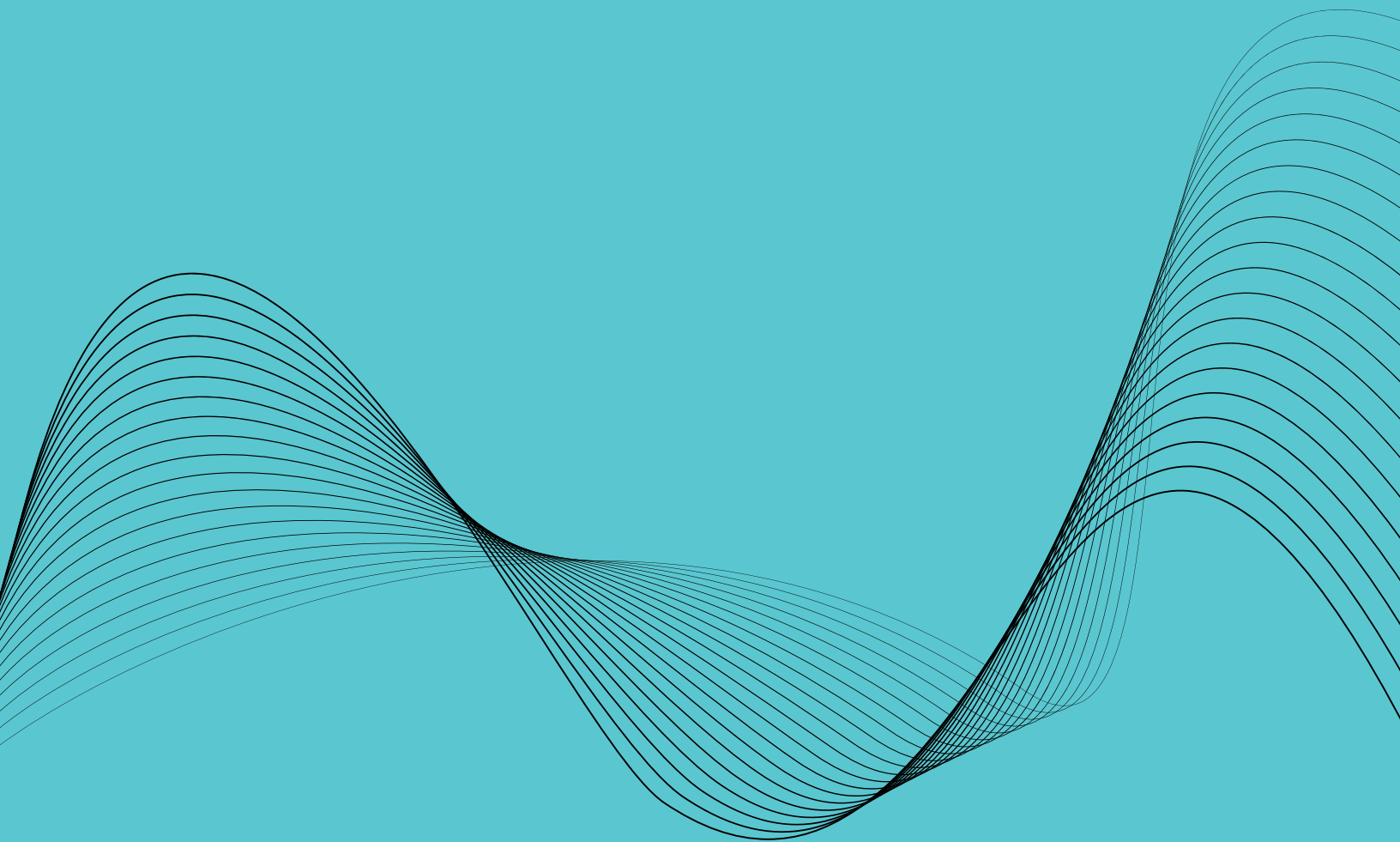

**AZENTA**  
LIFE SCIENCES

# Manufacturing & Quality Standards

Azenta is ISO 13485:2016 certified to manufacture and supply microplates and associated consumables for the life sciences sector. Our management systems comply with the requirements to produce certain medical devices which we sell to diagnostics companies of all sizes including multi-national corporations. We also provide complete custom design solutions from prototyping to tool design and contract manufacturing.



## Manufacturing Standard for Microplate and Associated Consumables

- ISO 13485:2016 certified
- Process validation & mapping
- Fully document controlled manufacturing processes
- Statistical analysis of production processes
- Continuous improvement programs
- Injection molding in ISO class 7 cleanrooms
- Virgin, medical grade polymers

## Quality Standard

Azenta performs visual, physical and biological tests to ensure the integrity of our PCR/Microplate consumables and that they are contamination free at all times.

- Consumables are certified free from human genomic DNA, nucleases and pyrogens
- Skirted microplates and PCR plates meet the SBS standard footprint
- PCR inhibition tests are performed on polymers used
- Leak tests are performed on every well of every PCR plate
- White-well plates are checked for background fluorescence



# PCR Plates: Clear, Frosted or White Wells & Low DNA Binding Properties



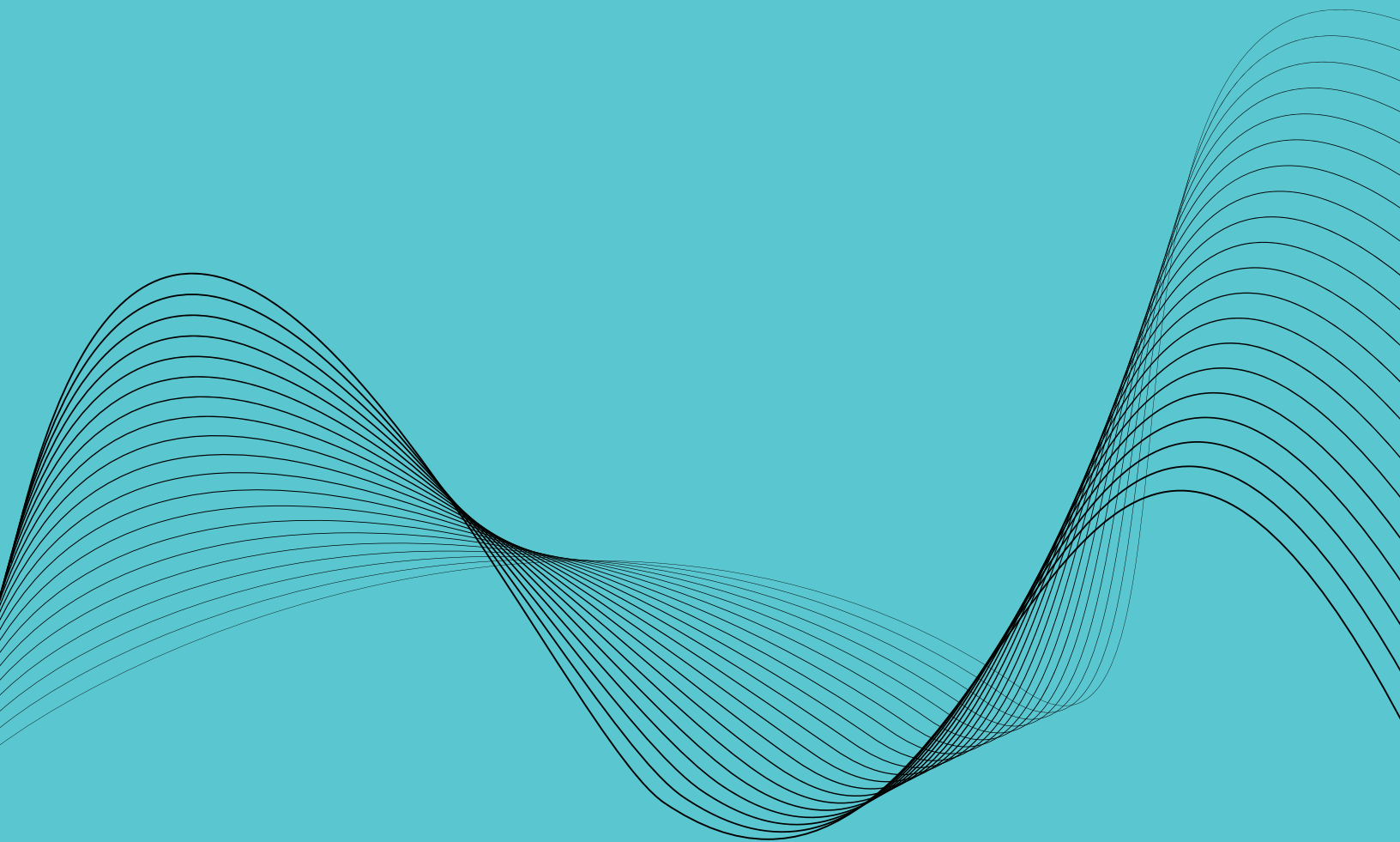

**AZENTA**  
LIFE SCIENCES

# Clear, Frosted or White Wells & Low DNA Binding Properties

Selection of the right plastic material of your PCR consumables has a measurable effect on your (q)PCR results. Azenta has carried out extensive research and development into our PCR consumables to offer customers a range of products suitable for the diverse applications and instruments they are required for.

## Well color options - A question of sensitivity

Well color is often not considered when choosing a PCR plate, but can in fact have a significant impact on results. PCR plates are available in three color options: clear, frosted and white, each of which has specific advantages and disadvantages.

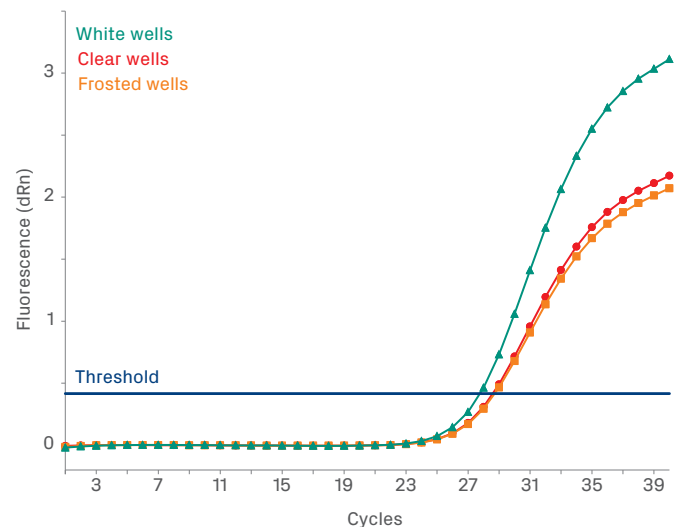
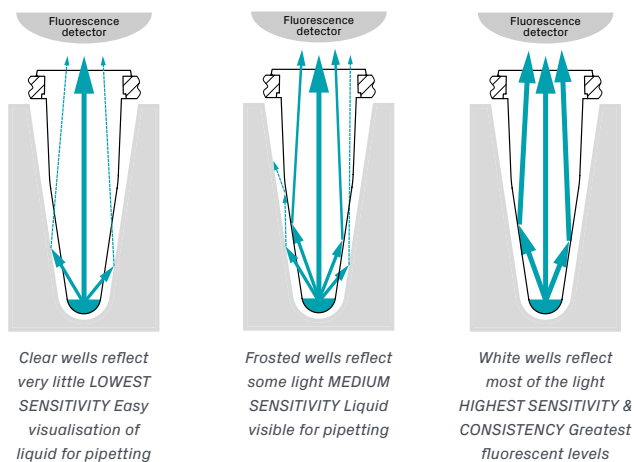

Greater sensitivity in a qPCR reaction enables earlier Ct values and higher fluorescence readings.

Identical qPCR assays in plates with clear, frosted and white wells (4ti-0770/C, 4ti-0772 and 4ti-0771, respectively). Clear and frosted wells perform similarly whereas white wells gave earlier Ct values and higher fluorescence intensity.

Azenta recommends the use of white wells, where possible, to achieve the greatest sensitivity and consistency of qPCR reactions. Another point to consider are well color recommendations from (q)PCR instrument manufacturers, for example, Roche recommend the use of white wells on their instruments and, ABI® recommend the use of frosted wells. In addition to using the recommended well color for your instrumentation, this must be combined with thin walled tubes for optimal heat transfer and optimal sealing to prevent evaporation.

## Low DNA binding - Smarter plastics for advanced applications

Polypropylene (PP) is the best material for PCR tubes as PP is chemically inert, resistant to solvents and well suited for injection molding, allowing for production of thin-walled tubes for optimum PCR results.

DNA has been shown to bind PP, especially at high ionic strength, despite the very hydrophobic nature of this material. This has typically not been an issue but due to progressing miniaturisation of reaction volumes and the introduction of new technologies such as NGS, ultra-low DNA binding consumables have become essential for use in sensitive assays.

Please see our dedicated application note on low DNA binding products which can be found on our website for information outlining the characteristics of our selected low bind polymer and for the range of low-binding PCR consumables available.





# Coding Options & Ethylene Oxide Treatment

## Linear and 2D datamatrix coding – Sample tracking made easy

All skirted and semi-skirted plates are available with linear Code 128 format barcodes for identification and traceability of your samples.

The labels are highly scratch-resistant and can withstand cold storage (-80°C), temperatures of up to 100°C, and solvents such as DMSO. Single, double, triple or quadruple barcodes are available, and a variety of custom options.

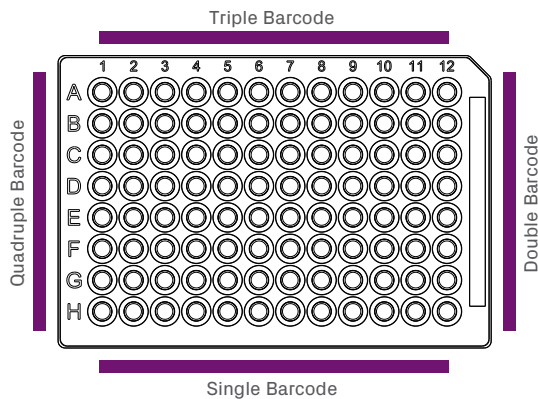

Position of standard barcode labels



8 Well PCR Tube Strip with PC Frame with off-the-shelf 2D code

2D datamatrix coding uses a defined number of fields to encode alphanumeric information. The code uses data redundancy so even if codes become partly destroyed, the information will be retained. Azenta offers 2D coding on several products including 8 Well PCR Tube Strips with PC Frame and PCR tubes with flat caps.

Should additional customizations not covered by our standard barcoding and 2D coding service be required, further information and our custom linear barcode request form can be found on our website.

## Ethylene Oxide Treatment – Reliable consumables for forensic applications



Azenta has a stringently controlled clean-room production facility, for production of PCR consumables free from DNA and RNA contamination. However, some applications require the absolute highest quality of consumables such as forensic workflows and tissue culture.

For these applications, Azenta offer treatment of selected products with Ethylene Oxide, a technique proven to reduce traces of amplifiable DNA, for peace of mind in your reactions. Additional plate types can be treated on request.

# FrameStar<sup>®</sup> 2-Component PCR Plates



# FrameStar 2-Component PCR Plates

FrameStar® PCR plates prevent sample loss by minimizing thermal expansion during PCR, enabling reductions in PCR volumes and cost savings on reagents.

The 2-component design combines the advantages of thin walled polypropylene (PP) tubes, for optimum PCR results, with a rigid polycarbonate (PC) frame for highest thermal stability and rigidity, making them the plates of choice for any robotic workflows.

- **Multiple frame color options with clear, frosted, white or black tubes are available**

Flexible solutions for every application

- **No warping due to stable polycarbonate frame**

Reliable use with stackers and liquid handlers

- **Minimizing thermal expansion**

Better sealing properties & reduced evaporation for improved PCR consistency

- **Downscaling of reaction volumes possible**

Cost saving

- **Standard and custom barcoding options available**

Error-free sample tracking

- **Plates with ultra-low DNA binding properties and processing options such as ethylene oxide treatment available**

Tailor-made solutions



## Evaporation from standard PCR plates vs. FrameStar plates

Thermal expansion of polypropylene (PP) plates leads to greater risk of evaporation from outer wells.

PP is the optimum material for PCR tubes. It provides the most efficient heat transfer, as well as an inert surface with low binding affinity to nucleic acids, proteins and other molecules. However, the material is not thermally stable in plate format, causing it to expand and contract during each PCR cycle. Such thermal expansion will weaken the plate seal and lead to sample evaporation, mainly from corner and outer wells.

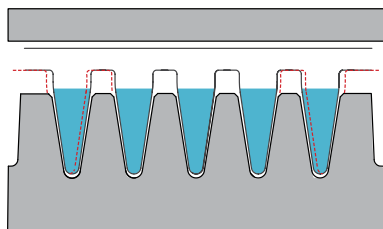

*Side-on view of a PCR plate in a thermal cycler. The sealed plate is sandwiched between the cycler block and the heated lid but it is only partly fixed in position at the bottom of tubes, allowing the plate to expand horizontally at the top.*

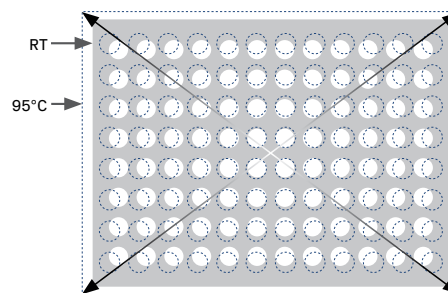

*Standard polypropylene plates expand by up to 2 mm during thermal cycling which leads to movement of wells away from the plate centre. This movement is most significant in corner and outer wells.*



## FrameStar 2-Component PCR Plates

FrameStar 2-component technology allows for reduction of assay volumes and cost.

Due to the much improved seal integrity, reaction volumes can often be reduced when using FrameStar plates. Such downscaling of experiments can be successfully implemented without any loss of assay sensitivity or consistency and, reagent savings can be considerable.

### Evaporation from standard PP plates is highest in the outer wells

Since thermal expansion and movement of wells in standard PP plates is greatest around the edges of the plates, evaporation is highest from the two outer rows of wells. The adjacent figure illustrates the level of risk of sample evaporation from different areas of PP plates. The inner 32 wells of a standard 96 well plate have low risk of evaporation whilst the risk of sample loss is much higher in the outer two rows which contain 65 per cent of the wells.

*“FrameStar plates led to significantly better results and reduced evaporation compared to standard PCR plates.”*

*Dr. Andreas Dahl, MPI f. Molekulare Genetik, Berlin, Germany*

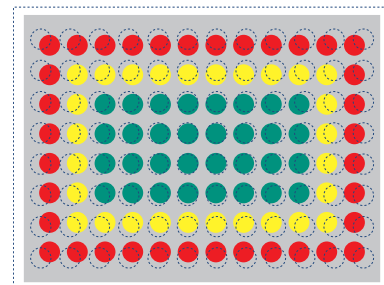

Risk of evaporation from the outer rows (red) of a standard PP PCR plate is highest, medium level evaporation occurs in the second row (yellow) and sample loss from the inner 32 wells (green) is lowest (the dotted line represents an expanded standard PP plate).

### FrameStar 2-component plates improve consistency of PCR results

We have compared the degree of evaporation from different areas of standard PP and FrameStar PCR plates. First, the 64 outer wells (two outer rows - above, red and yellow area) of both plate types were filled with 10 µl H<sub>2</sub>O. Plates were then sealed with a qPCR adhesive seal (code 4ti-0560) and their total weight determined before and after PCR. The experiment was repeated with a set of plates of which the inner 32 wells (green area) were filled. Table 1 shows that evaporation from outer wells of standard PP plates was 65 higher than from inner wells. As a result, evaporation causes varying changes in reaction volume across standard PP plates.

The results below show that reaction volumes remain consistent across the 96 wells (or 384 wells, data not shown) in FrameStar plates. In contrast, the reaction volumes in standard plates differ significantly between wells during PCR. Reagent concentrations in outer rows will increase dramatically, resulting in sub-optimal reaction efficiency. In extreme cases samples may fully evaporate.

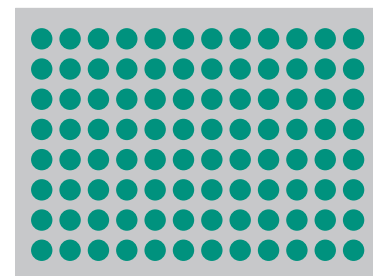

The polycarbonate frame of FrameStar plates is more heat resistant than standard polypropylene plates which reduces thermal expansion to a minimum. For this reason seal integrity remains intact even at elevated temperatures during PCR.

### FrameStar minimizes sample loss across the plate

Plate Type	Well position	Starting weight (g)	Weight post PCR (g)	Weight loss (g)	Volume loss	
					Total	Per well
FrameStar 4ti-0710	outer 64 wells	26.230	26.193	0.037	37 µl	0.57 µl
Standard PP	outer 64 wells	17.299	17.118	0.181	181 µl	2.8 µl
FrameStar 4ti-0710	inner 32 wells	25.841	25.824	0.017	17 µl	0.53 µl
Standard PP	inner 32 wells	17.132	17.078	0.054	54 µl	1.69 µl

Table 1: Weight and volume loss from different sections of 96 well PCR plates. Results shown are averages from 5 plates of each plate type. Volume loss from the outer wells of standard PP plates was 5-times higher than from FrameStar plates.

*Evaporation has a significant effect on the reaction conditions resulting in noticeable effects, especially for qPCR. Identical samples can exhibit significant differences in their Ct values, depending on their position on the plate.*

*A solution to the problem of evaporation related qPCR inaccuracies is the use of 2-component plates.*



**AZENTA**  
LIFE SCIENCES

# FrameStar 384 Well Skirted PCR Plate

**Polypropylene wells, polycarbonate frame, cut corner A24; working volume: <30 µl, total well capacity: 55 µl; designed for use on standard thermal cyclers**

- Our FrameStar 384 Well Skirted PCR Plates are designed for high-throughput PCR
- Compatible with the majority of 384 well block PCR, qPCR and sequencing instruments
- Rigid 2-component design eliminates warping and distortion during PCR making it ideal for use with robotic systems
- The skirt allows for labeling or barcoding
- Ultra-low DNA binding option available

## Key Features

- Free from DNase, RNase, human genomic DNA, and endotoxin/pyrogen
- Stackable

## Wells

- Ultra-smooth, uniform, thin-walled polypropylene tubes for optimum PCR and real-time (RT-qPCR) results
- <30 µl working volume, 55 µl total well capacity

## Frame

- Rigid polycarbonate frame for added mechanical stability
- Significantly reduced thermal expansion and sample evaporation for improved consistency in PCR results
- Improved seal integrity due to thermal stability of the frame
- Alphanumeric grid reference to aid well and sample identification

## Use

- Recommended for low volume PCR
- Compatible with standard multichannel pipettes
- Ideal for use with robotic systems
- Compatible with the majority of 384 well block PCR, qPCR and sequencing instruments



## Options

- Available with the following frame color options for the clear well variety: purple, blue, clear, green, red, and black
- Also available as a black frame with white wells (for optimum signal-to-noise ratio when using fluorescent based assays) and as a black frame with black wells (for minimal light diffusion and interference)
- Also available as a clear frame with frosted wells for use with ABI®/LifeTechnologies® qPCR instruments
- Available barcoded upon request



## FrameStar 384 Well Skirted PCR Plate

### Specifications

Parameter	Value
Plate length	127.76 ± 0.25 mm
Plate width	85.48 ± 0.25 mm
Plate height	10.30 ± 0.05 mm
Well depth	9.20 ± 0.10 mm
Well diameter	3.00 ± 0.10 mm
Distance to center of A1 from top edge	8.99 ± 0.25 mm
Distance to center of A1 from left edge	12.13 ± 0.25 mm
Pitch (distance between A1 and A2)	4.50 mm

### Ordering Information

<b>4ti-0384</b>	FrameStar 384 Well Skirted PCR Plate, clear PP wells, purple PC frame, cut corner A24, 50 plates per case
<b>4ti-0384/B</b>	FrameStar 384 Well Skirted PCR Plate, clear PP wells, blue PC frame, cut corner A24, 50 plates per case
<b>4ti-0384/C</b>	FrameStar 384 Well Skirted PCR Plate, clear PP wells, clear PC frame, cut corner A24, 50 plates per case
<b>4ti-LB0384/C</b>	FrameStar 384 Well Skirted PCR Plate, clear PP wells, clear PC frame, low binding, cut corner at A24, 50 plates per case
<b>4ti-0384/G</b>	FrameStar 384 Well Skirted PCR Plate, clear PP wells, green PC frame, cut corner A24, 50 plates per case
<b>4ti-0384/R</b>	FrameStar 384 Well Skirted PCR Plate, clear PP wells, red PC frame, cut corner A24, 50 plates per case
<b>4ti-0384/X</b>	FrameStar 384 Well Skirted PCR Plate, clear PP wells, black PC frame, cut corner A24, 50 plates per case
<b>4ti-0384/RIG</b>	FrameStar 384 Well Skirted PCR Plate, clear PP wells, black PC frame, extra rigid, low profile, cut corner A24, 50 plates per case
<b>4ti-LB0384/RIG</b>	FrameStar 384 Well Skirted PCR Plate, clear PP wells, black PC frame, extra rigid, low binding, low profile, cut corner A24, 50 plates per case
<b>4ti-0385</b>	FrameStar 384 Well Skirted PCR Plate, white PP wells, black PC frame, cut corner A24, 50 plates per case
<b>4ti-0386</b>	FrameStar 384 Well Skirted PCR Plate, black PP wells, black PC frame, cut corner A24, 50 plates per case
<b>4ti-0387</b>	FrameStar 384 Well Skirted PCR Plate, frosted PP wells, clear PC frame, cut corner A24, 50 plates per case

For recommended plate options depending on manufacturer, block type, and instrument please refer to the Azenta Plate Instrument Compatibility Table Page 187.

# FrameStar 384 Well Skirted PCR Plate, Roche Style

**Polypropylene wells, polycarbonate frame, cut corners A24 and P24; working volume: <30 µl, total well capacity: 55 µl; designed for use on the Roche LightCycler® 480 with 384 well block**

- The dimensions of these plates are designed for optimum compatibility with the Roche LightCycler® 480, and are in a 384 well format for reaction volumes of up to 30 µl
- The rigid two-component design eliminates warping and distortion during the PCR process, making it ideal for use with robotic systems

## Key Features

- Free from DNase, RNase, human genomic DNA, and endotoxin/pyrogen
- Stackable

## Wells

- Ultra-smooth, uniform, thin-walled polypropylene wells for optimum PCR and real-time (RT-qPCR) results
- <30 µl working volume, 55 µl total well capacity

## Frame

- Rigid polycarbonate frame for added mechanical stability
- Significantly reduced thermal expansion and sample evaporation for improved consistency in PCR results
- Improved seal integrity due to thermal stability of frame
- Alphanumeric grid reference to aid well and sample identification

## Use

- Compatible with Roche LightCycler® 480
- Recommended for low volume PCR
- Compatible with standard multichannel pipettes
- Ideal for use with robotic systems

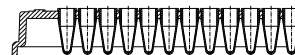

## Options

- Available as a clear polycarbonate frame with clear polypropylene wells
- Also available with white wells for optimum signal-to-noise ratio when using fluorescent based assays
- Available barcoded upon request
- Combi packs available with qPCR Seal (4ti-0560)



## FrameStar 384 Well Skirted PCR Plate, Roche Style

### Specifications

Parameter	Value
Plate length	127.76 ± 0.25 mm
Plate width	85.48 ± 0.25 mm
Plate height	10.60 ± 0.25 mm
Well depth	9.20 ± 0.10 mm
Well diameter	3.00 ± 0.10 mm
Distance to center of A1 from top edge	8.99 ± 0.25 mm
Distance to center of A1 from left edge	12.13 ± 0.25 mm
Pitch (distance between A1 and A2)	4.50 mm

### Ordering Information

<b>4ti-0380/C</b>	FrameStar 384 Well Skirted PCR Plate, Roche style, clear PP wells, clear PC frame, cut corner A24/P24, 50 plates per case
<b>4ti-0381</b>	FrameStar 384 Well Skirted PCR Plate, Roche style, white PP wells, clear PC frame, cut corner A24/P24, 50 plates per case
<b>Combi Pack</b>	
<b>4ti-0382</b>	FrameStar 384 Well Skirted PCR Plate, Roche style, plus qPCR Seal, 4ti-0381 plus 4ti-0560, combi pack, 50 plates and seals per case
<b>4ti-0383</b>	FrameStar 384 Well Skirted PCR Plate, Roche style, plus qPCR Seal, 4ti-0380/C plus 4ti-0560, combi pack, 50 plates and seals per case

*For recommended plate options depending on manufacturer, block type, and instrument please refer to the Azenta Plate Instrument Compatibility Table Page 187.*



# FrameStar 96 Well Skirted PCR Plate

**Low profile, 0.1 ml polypropylene wells, polycarbonate frame, cut corner H1; working volume: <100 µl, total well capacity: 200 µl**

- The low profile wells of this plate are shorter than “standard” profile wells, which decrease the “dead space” between the heated lid of the thermal cycler and the sample in the well
- Eliminates condensation forming on the side wall of the tubes, preventing reduction in PCR volume and increasing the efficiency of the reaction
- Especially recommended for reaction volumes below 20 µl
- The rigid polycarbonate skirt of this design eliminates warping and distortion during PCR, and makes it ideal for use with robotic systems
- Ultra-low DNA binding option available

## Key Features

- Free from DNase, RNase, human genomic DNA, and endotoxin/pyrogen
- Stackable

## Wells

- Ultra-smooth, uniform, thin-walled polypropylene tubes for optimum PCR and real-time (RT-qPCR) results
- <0.1 ml (100 µl) working volume, 0.2 ml (200 µl) total well capacity

## Frame

- Rigid polycarbonate frame for added mechanical stability
- Significantly reduced thermal expansion and sample evaporation for improved consistency in PCR results
- Improved seal integrity due to thermal stability of frame
- Alphanumeric grid reference to aid well and sample identification

## Use

- Recommended for low volume PCR
- Ideal for use with robotic systems
- Compatible with standard multichannel pipettes

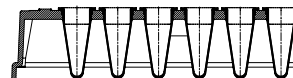

## Options

- Available with the following frame color options for the clear well variety: purple, blue, clear, green, red, black, and white
- Also available with a black frame and with a clear frame for the white well variety, for optimum signal-to-noise ratio when using fluorescent based assays
- Also available as a black frame with black wells for non-PCR fluorescent applications
- Extra rigid skirt option (4ti-0960/RIG) for use with Perkin-Elmer® Sciclone, Beckman, Hamilton, and other automation systems: eliminates the robotic grip picking up more than one plate at a time
- Ethylene oxide treated option available (4ti-OX960C/SBC) for forensic use
- Ultra-low DNA binding option available (4ti-LB0960/RIG) for sensitive applications with ultra-low DNA input and for maximum DNA recovery after low temperature storage and high temperature incubation
- Available barcoded on request
- Combi packs available (for 4ti-0960) with Optically Clear Windowed qPCR Seal (4ti-0565)
- Clear Polystyrene Lid (4ti-0287) compatible with PCR plates & robotics

*For recommended plate options depending on manufacturer, block type, and instrument please refer to the Azena Plate Instrument Compatibility Table Page 187.*



**AZENTA**  
LIFE SCIENCES

## FrameStar 96 Well Skirted PCR Plate

### Specifications

Parameter	Value
Plate length	127.76 ± 0.25 mm
Plate width	85.48 ± 0.25 mm
Plate height	16.10 ± 0.05 mm
Well depth	15.10 ± 0.10 mm
Well diameter	5.50 ± 0.10 mm
Distance to center of A1 from top edge	11.24 ± 0.25 mm
Distance to center of A1 from left edge	14.38 ± 0.25 mm
Pitch (distance between A1 and A2)	9.00 mm

### Ordering Information

<b>4ti-0960</b>	FrameStar 96 Well Skirted PCR Plate, clear PP wells, purple PC frame, low profile, cut corner H1, 50 plates per case
<b>4ti-0960/B</b>	FrameStar 96 Well Skirted PCR Plate, clear PP wells, blue PC frame, low profile, cut corner H1, 50 plates per case
<b>4ti-0960/C</b>	FrameStar 96 Well Skirted PCR Plate, clear PP wells, clear PC frame, low profile, cut corner H1, 50 plates per case
<b>4ti-0960/G</b>	FrameStar 96 Well Skirted PCR Plate, clear PP wells, green PC frame, low profile, cut corner H1, 50 plates per case
<b>4ti-0960/R</b>	FrameStar 96 Well Skirted PCR Plate, clear PP wells, red PC frame, low profile, cut corner H1, 50 plates per case
<b>4ti-0960/X</b>	FrameStar 96 Well Skirted PCR Plate, clear PP wells, black PC frame, low profile, cut corner H1, 50 plates per case
<b>4ti-0960/W</b>	FrameStar 96 Well Skirted PCR Plate, clear PP wells, white PC frame, low profile, cut corner H1, 50 plates per case
<b>4ti-0961</b>	FrameStar 96 Well Skirted PCR Plate, white PP wells, black PC frame, low profile, cut corner H1, 50 plates per case
<b>4ti-0961/C</b>	FrameStar 96 Well Skirted PCR Plate, white PP wells, clear PC frame, low profile, cut corner H1, 50 plates per case
<b>4ti-0966</b>	FrameStar 96 Well Skirted PCR Plate, black PP wells, black PC frame, low profile, cut corner H1, 50 plates per case
<b>4ti-OX960C/SBC</b>	FrameStar 96 Well Semi-Skirted PCR Plate, clear PP wells, clear PC frame, with upstand, ethylene oxide treated, single barcoded, low profile, cut corner H1, 20 plates per case
<b>4ti-0960/RIG</b>	FrameStar 96 Well Skirted PCR Plate, clear PP wells, black PC frame, extra rigid, low profile, cut corner H1, 50 plates per case
<b>4ti-LB0960/RIG</b>	FrameStar 96 Well Skirted PCR Plate, clear PP wells, black PC frame, extra rigid, low binding, low profile, cut corner H1, 50 plates per case
<b>Combi Pack</b>	
<b>4ti-0960/0565</b>	FrameStar 96 Well Skirted PCR Plate, plus Optically clear windowed qPCR seal, 4TI-0960 plus 4TI-0565, combi pack, 50 plates and seals per case

For recommended plate options depending on manufacturer, block type, and instrument please refer to the Azenta Plate Instrument Compatibility Table Page 187.

# FrameStar 96 Well Skirted Optical Bottom PCR Plate

Low profile, flat optical bottom, 0.1ml clear polypropylene wells, clear polycarbonate frame, cut corner H1, working volume: <100µl, total well capacity: 180µl

- The FrameStar 96 Well Skirted Optical Bottom PCR Plates (next to their counterpart within our Individual Access range, 4ti-0970/RA) are currently unique in the market, being suitable for use in both microscopy and PCR
- Optical bottom plates are ideal for applications requiring single cell sorting followed by molecular biology techniques such as (q)PCR and sequencing
- The flat bottoms enable excellent stackability, making these plates well suited for small sample volume storage such as compound libraries, with no risk of damaging the seal of the plate below
- Additionally, the small well volume enables excellent sample recovery
- The low profile wells of this plate are shorter than “standard” profile wells, which decreases the “dead space” between the heated lid of the thermal cycler and the reagents in the well
- This reduces condensation forming on the side wall of the tubes, moderating changes in PCR volume and increasing the efficiency of the reaction
- This is especially recommended for reaction volumes below 20µl
- The rigid polycarbonate skirt of this design eliminates warping and distortion during PCR, and makes it ideal for use with robotic systems

## Key Features

- Free from DNase, RNase, human genomic DNA, and endotoxin/pyrogen
- Stackable

## Well

- Ultra-smooth, uniform, thin-walled polypropylene wells for optimum PCR and real-time (RT-qPCR) results
- <0.1ml (100µl) working volume, 0.18ml (180µl) total well capacity

## Frame

- Rigid polycarbonate frame for added mechanical stability
- Significantly reduced thermal expansion and sample evaporation for improved consistency in PCR results
- Improved seal integrity due to thermal stability of frame
- Alphanumeric grid reference to aid well and sample identification



## Use

- Suitable for microscopy and small volume sample storage
- Recommended for low volume PCR
- Compatible with standard multichannel pipettes
- Ideal for use with robotic systems

## Options

- Also available as an Individual Access plate (4ti-0970/RA) with individually detachable and sealable wells
- Available barcoded upon request

## Specifications

Parameter	Value
Plate length	127.70 ± 0.25mm
Plate width	85.48 ± 0.25mm
Plate height	16.10 ± 0.25mm
Well depth	12 ± 0.10mm
Well diameter	5.46 ± 0.10mm
Distance to center of A1 from top edge	11.24 ± 0.25mm
Distance to center of A1 from left edge	14.38 ± 0.25mm
Pitch (distance between A1 and A2)	9.00 mm

## Ordering Information

<b>4ti-0970</b>	<b>FrameStar 96 Well Skirted Optical Bottom PCR Plate, clear PP wells, clear PC frame, low profile, cut corner H1, 50 plates per case</b>
-----------------	---



# FrameStar 96 Well Semi-Skirted PCR Plate, Roche Style

Low profile, 0.1ml polypropylene wells, polycarbonate frame, cut corner H12; working volume: <100µl, total well capacity: 200µl; designed for use on Roche LightCycler® 96 and 480 (with 96 well block)

- Our FrameStar Roche Style plates are designed to achieve optimized assay conditions on the Roche LightCycler® 96 and 480 (with 96 well block)
- This particular style of plate is in a low profile 96-well format; perfect for reaction volumes of 10-100µl
- The wells are shorter than “standard” profile wells, which decrease the “dead space” between the heated lid of the thermal cycler and the sample in the well
- This eliminates condensation forming on the side wall of the tubes, preventing reduction in PCR volume and increasing the efficiency of the reaction
- This is especially recommended for reaction volumes below 20µl
- The semi-skirted frame allows for labeling or barcoding

## Key Features

- Free from DNase, RNase, human genomic DNA, and endotoxin/pyrogen

## Well

- Ultra-smooth, uniform, thin-walled polypropylene tubes for optimum PCR and real-time (RT-qPCR) results
- <0.1ml (100µl) working volume, 0.2ml (200µl) total well capacity

## Frame

- Rigid polycarbonate frame for added mechanical stability
- Significantly reduced thermal expansion and sample evaporation for improved consistency in PCR results
- Improved seal integrity due to thermal stability of frame
- Alphanumeric grid reference to aid well and sample identification

## Use

- Compatible with the Roche LightCycler® 96 and 480 (with 96 well block)
- Recommended for low volume PCR
- Ideal for use with robotic systems
- Compatible with standard multichannel pipettes

## Options

- Standard plate comes with clear polypropylene wells on a clear polycarbonate frame
- Also available with white wells for optimum signal-to-noise ratio when using fluorescent based assays



- Available barcoded upon request
- Combi packs available with qPCR adhesive seal (4ti-0560) and (for 4ti-0951) with Optically Clear Windowed qPCR Seal (4ti-0564)

## Specifications

Parameter	Value
Plate length	127.70 ± 0.25mm
Plate width	85.48 ± 0.25mm
Plate height	15.60 ± 0.25mm
Well depth	15.10 ± 0.10mm
Well diameter	5.50 ± 0.10mm
Distance to center of A1 from top edge	11.24 ± 0.25mm
Distance to center of A1 from left edge	14.38 ± 0.25mm
Pitch (distance between A1 and A2)	9.00 mm

## Ordering Information

4ti-0950/C	FrameStar 96 Well Semi-Skirted PCR Plate, Roche style, clear PP wells, clear PC frame, low profile, cut corner H12, 50 plates per case
4ti-0951	FrameStar 96 Well Semi-Skirted PCR Plate, Roche style, white PP wells, clear PC frame, low profile, cut corner H12, 50 plates per case
Combi Packs	
4ti-0952	FrameStar 96 Well Semi-Skirted PCR Plate, Roche style, plus qPCR Seal, 4TI-0951 plus 4TI-0560, combi pack, 50 plates and seals per case
4ti-0953	FrameStar 96 Well Semi-Skirted PCR Plate, Roche style, plus qPCR Seal, 4TI-0950/C plus 4TI-0560, combi pack, 50 plates and seals per case
4ti-0951/0565	FrameStar 96 Well Semi-Skirted PCR Plate, Roche style, plus Optically clear windowed qPCR seal, 4TI-0951 plus 4TI-0565, combi pack, 50 plates and seals per case

# FrameStar 96 Well Semi-Skirted PCR Plate, Roche Style, High Sensitivity

Low profile, 0.1 ml polypropylene wells, polycarbonate frame, cut corner H12, working volume: <100 µl, total well capacity: 200 µl; designed for use on Roche LightCycler® 96 and 480 (with 96 well block); extra white wells for improved sensitivity in fluorescent assays

- Our FrameStar Roche Style plates are designed to achieve optimized assay conditions on the Roche LightCycler® 96 and 480 (with 96 well block)
- This particular style of plate is in a low profile 96-well format; perfect for reaction volumes of 10-100 µl
- The wells are shorter than “standard” profile wells, which decrease the “dead space” between the heated lid of the thermal cycler and the sample in the well. This eliminates condensation forming on the side wall of the tubes, preventing reduction in PCR volume and increasing the efficiency of the reaction
- Especially recommended for reaction volumes below 20 µl
- The extra white wells allow for increased sensitivity in fluorescent assays
- The semi-skirted frame allows for labeling or barcoding

## Key Features

- Free from DNase, RNase, human genomic DNA, and endotoxin/pyrogen

## Wells

- Ultra-smooth, uniform, thin-walled polypropylene tubes for optimum PCR and real-time (RT-qPCR) results
- <0.1 ml (100 µl) working volume, 0.2 ml (200 µl) total well capacity

## Frame

- Rigid polycarbonate frame for added mechanical stability
- Significantly reduced thermal expansion and sample evaporation for improved consistency in PCR results
- Improved seal integrity due to thermal stability of frame
- Alphanumeric grid reference to aid well and sample identification

## Use

- Compatible with the Roche LightCycler® 96 and 480 (with 96 well block)
- Recommended for low volume PCR
- Compatible with standard multichannel pipettes
- Ideal for use with robotic systems

## Options

- Plates are available with a clear polycarbonate frame and extra white wells for improved sensitivity when using fluorescent based assays
- Combi packs available with qPCR Adhesive Seal (4ti-0560)
- Available barcoded upon request

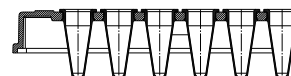
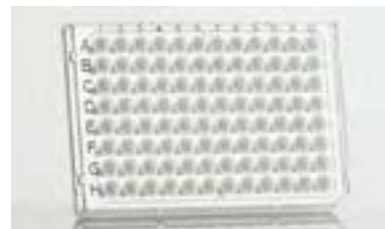

## Specifications

Parameter	Value
Plate length	127.70 ± 0.25 mm
Plate width	85.48 ± 0.25 mm
Plate height	15.60 ± 0.05 mm
Well depth	15.10 ± 0.10 mm
Well diameter	5.50 ± 0.10 mm
Distance to center of A1 from top edge	11.24 ± 0.25 mm
Distance to center of A1 from left edge	14.38 ± 0.25 mm
Pitch (distance between A1 and A2)	9.00 mm

## Ct values Comparison

FrameStar Roche Style, High Sensitivity Plate	
Ct value	17.23
Δ Ct	-3.05
Competitor R equivalent plates	
Ct value	20.28
Δ Ct	0

## Ordering Information

<b>4ti-0954</b>	FrameStar 96 Well Semi-Skirted PCR Plate, Roche style, High Sensitivity, extra white PP wells, clear PC frame, low profile, cut corner H12, 50 plates per case
<b>Combi Pack</b>	
<b>4ti-0954/0560</b>	FrameStar 96 Well Semi-Skirted PCR Plate, Roche style, High Sensitivity, extra white PP wells, plus qPCR Seal, 4TI-0954 plus 4TI-0560, combi pack, 50 plates and seals per case

For recommended plate options depending on manufacturer, block type, and instrument please refer to the Azenta Plate Instrument Compatibility Table Page 187.

# FrameStar 96 Well Semi-Skirted PCR Plate, ABI® FastPlate Style

Low profile, 0.1 ml polypropylene wells, polycarbonate frame with upstand, cut corner A1, working volume: <100 µl, total well capacity: 200 µl; designed for use on ABI® Fast Block cyclers

- This semi-skirted low profile plate is recommended for use with ABI® Fast block thermal cyclers
- The low profile wells of this plate are shorter than “standard” profile wells, which decrease the “dead space” between the heated lid of the thermal cycler and the sample in the well
- This eliminates condensation forming on the side wall of the tubes, preventing reduction in PCR volume and increasing the efficiency of the reaction
- Especially recommended for reaction volumes below 20 µl
- The rigid polycarbonate skirt of this design eliminates warping and distortion during PCR, and makes it ideal for use with robotic systems. Its skirt also allows for labeling or barcoding

## Key Features

- Free from DNase, RNase, human genomic DNA, and endotoxin/pyrogen
- Stackable

## Wells

- Ultra-smooth, uniform, thin-walled polypropylene tubes for optimum PCR and real-time (RT-qPCR) results
- <0.1 ml (100 µl) working volume, 0.2 ml (200 µl) total well capacity

## Frame

- Rigid polycarbonate frame for added mechanical stability
- Significantly reduced thermal expansion and sample evaporation for improved consistency in PCR results

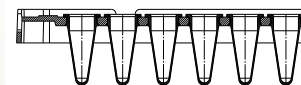
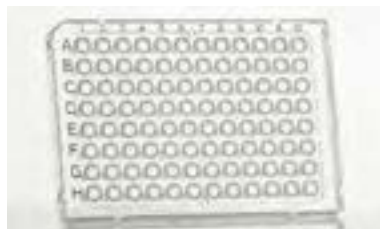

- Improved seal integrity due to thermal stability of frame
- Alphanumeric grid reference to aid well and sample identification

## Use

- Compatible with ABI® Fast block thermal cyclers
- Recommended for low volume PCR
- Compatible with standard multichannel pipettes
- Ideal for use with robotic systems

## Options

- Standard plate comes with clear polypropylene wells with a clear polypropylene frame
- Also available with white wells for optimum signal-to-noise ratio when using fluorescent based assays
- Also available as a clear frame with frosted wells for use with ABI®/LifeTechnologies® qPCR instruments
- Combi packs available (for 4ti-0910/C) with Optically Clear Windowed qPCR Seal (4ti-0565)
- Available barcoded upon request

## Ordering Information

4ti-0910/C	FrameStar 96 Well Semi-Skirted PCR Plate, ABI Fastplate style, clear PP wells, clear PC frame, with upstand, low profile, cut corner A1, 50 plates per case
4ti-0910/C/10P	FrameStar 96 Well Semi-Skirted PCR Plate, ABI Fastplate style, clear PP wells, clear PC frame, with upstand, low profile, cut corner A1, 10 plates per case
4ti-0911	FrameStar 96 Well Semi-Skirted PCR Plate, ABI Fastplate style, white PP wells, clear PC frame, with upstand, low profile, cut corner A1, 50 plates per case
4ti-0912	FrameStar 96 Well Semi-Skirted PCR Plate, ABI Fastplate style, frosted PP wells, clear PC frame, with upstand, low profile, cut corner A1, 50 plates per case
4ti-0912/10P	FrameStar 96 Well Semi-Skirted PCR Plate, ABI Fastplate style, frosted PP wells, clear PC frame, with upstand, low profile, cut corner A1, 10 plates per case
Combi Pack	
4ti-0910/C/ 0565	FrameStar 96 Well Semi-Skirted PCR Plate, ABI Fastplate style, plus Optically clear windowed qPCR seal, 4TI-0910/C plus 4TI-0656, combi pack, 50 plates and seals per case

## Specifications

Parameter	Value
Plate length	127.70 ± 0.25 mm
Plate width	85.48 ± 0.25 mm
Plate height	16.70 ± 0.10 mm
Well depth	15.10 ± 0.10 mm
Well diameter	5.50 ± 0.10 mm
Distance to center of A1 from top edge	11.24 ± 0.25 mm
Distance to center of A1 from left edge	14.38 ± 0.25 mm
Pitch (distance between A1 and A2)	9.00 mm

For recommended plate options depending on manufacturer, block type, and instrument please refer to the Azenta Plate Instrument Compatibility Table Page 187.

# FrameStar 96 Well Semi-Skirted PCR Plate With Upstand, ABI® Style

High profile, 0.2 ml polypropylene wells, polycarbonate frame with upstand, cut corner A12, working volume: <200 µl, total well capacity: 300 µl; designed for use on ABI® instruments

- This ABI® Style PCR plate offers the benefits of our 2-component design to ABI® standard block users
- This design combines the advantages of ultra-thin wall polypropylene tubes for optimum PCR results with a rigid polycarbonate skirt and deck for the highest thermal stability
- We recommend this semi-skirted plate for use with ABI® thermal cyclers and sequencers; it can be used directly with ABI® instruments with no adapters necessary
- The only case where this is not true is with the ABI Fast Block thermal cyclers; in this case, using our FrameStar Fast Plate is recommended instead

## Key Features

- Free from DNase, RNase, human genomic DNA, and endotoxin/pyrogen

## Wells

- Ultra-smooth, uniform, thin-walled polypropylene tubes for optimum PCR and real-time quantitative PCR (RT-qPCR) results
- <0.2 ml (200 µl) working volume, 0.3 ml (300 µl) total well capacity

## Frame

- Rigid polycarbonate frame for added mechanical stability
- Significantly reduced thermal expansion and sample evaporation for improved consistency in PCR results
- Improved seal integrity due to thermal stability of frame
- Alphanumeric grid reference to aid well and sample identification

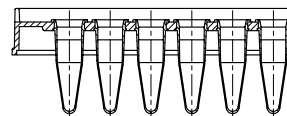

## Use

- Ideal for use with ABI® thermal cyclers & sequencers
- Recommended for low volume PCR
- Compatible with standard multichannel pipettes
- Ideal for use with robotic systems

## Options

- Available with the following frame color options for the clear well variety: purple, blue, clear, green, red, and black
- Also available as a black frame with white wells for optimum signal-to-noise ratio when using fluorescent based assays
- Ethylene oxide treated option available for forensic use
- Available barcoded upon request
- Combi packs available (for 4ti-0730/C) with Optically Clear Windowed qPCR Seal (4ti-0565)



## FrameStar 96 Well Semi-Skirted PCR Plate With Upstand, ABI® Style

### Specifications

Parameter	Value
Plate length	124.26 ± 0.25 mm
Plate width	83.97 ± 0.25 mm
Plate height	23.20 ± 0.05 mm
Well depth	20.20 ± 0.10 mm
Well diameter	5.46 ± 0.10 mm
Distance to center of A1 from top edge	10.495 ± 0.25 mm
Distance to center of A1 from left edge	12.63 ± 0.25 mm
Pitch (distance between A1 and A2)	9.00 mm

### Ordering Information

<b>4ti-0730</b>	<b>FrameStar 96 Well Semi-Skirted PCR Plate, ABI style, clear PP wells, purple PC frame, with upstand, high profile, cut corner A12, 50 plates per case</b>
<b>4ti-0730/B</b>	<b>FrameStar 96 Well Semi-Skirted PCR Plate, ABI style, clear PP wells, blue PC frame, with upstand, high profile, cut corner A12, 50 plates per case</b>
<b>4ti-0730/C</b>	<b>FrameStar 96 Well Semi-Skirted PCR Plate, ABI style, clear PP wells, clear PC frame, with upstand, high profile, cut corner A12, 50 plates per case</b>
<b>4ti-0730/C/10P</b>	<b>FrameStar 96 Well Semi-Skirted PCR Plate, ABI style, clear PP wells, clear PC frame, with upstand, high profile, cut corner A12, 10 plates per case</b>
<b>4ti-0730/G</b>	<b>FrameStar 96 Well Semi-Skirted PCR Plate, ABI style, clear PP wells, green PC frame, with upstand, high profile, cut corner A12, 50 plates per case</b>
<b>4ti-0730/R</b>	<b>FrameStar 96 Well Semi-Skirted PCR Plate, ABI style, clear PP wells, red PC frame, with upstand, high profile, cut corner A12, 50 plates per case</b>
<b>4ti-0730/X</b>	<b>FrameStar 96 Well Semi-Skirted PCR Plate, ABI style, clear PP wells, black PC frame, with upstand, high profile, cut corner A12, 50 plates per case</b>
<b>4ti-OX730C/SBC</b>	<b>FrameStar 96 Well Semi-Skirted PCR Plate, ABI Style, clear PP wells, clear PC frame, with upstand, ethylene oxide treated, single barcoded, high profile, cut corner A12, 20 plates per case</b>
<b>Combi Pack</b>	
<b>4ti-0730/C/0565</b>	<b>FrameStar 96 Well Semi-Skirted PCR Plate, ABI style, clear PP wells, clear PC frame, with upstand, high profile, cut corner A12, 50 plates per case plus 4ti-0565</b>

*For recommended plate options depending on manufacturer, block type, and instrument please refer to the Azenta Plate Instrument Compatibility Table Page 187.*



# FrameStar 96 Well Semi-Skirted PCR Plate, ABI® Style

High profile, 0.2 ml polypropylene wells, polycarbonate frame, cut corner A12; working volume: <200 µl, total well capacity: 300 µl; designed for use on all major cyclers, including ABI® instruments with standard 96 well blocks

- Specifically designed to be directly compatible with all major thermal cyclers, this plate can be used directly in ABI® 96 well instruments without the need for any adapters
- The rigid FrameStar 2-component design eliminates warping and distortion during PCR, making it ideal for use with robotic systems
- The semi-skirt allows for labeling or barcoding for sample tracking

## Key Features

- Free from DNase, RNase, human genomic DNA, and endotoxin/pyrogen

## Wells

- Ultra-smooth, uniform, thin-walled polypropylene tubes for optimum PCR and real-time (RT-qPCR) results
- <0.2 ml (200 µl) working volume, 0.3 ml (300 µl) total well capacity

## Frame

- Cut corner at A12
- Rigid polycarbonate frame for added mechanical stability
- Significantly reduced thermal expansion and sample evaporation for improved consistency in PCR results
- Improved seal integrity due to thermal stability of frame
- Alphanumeric grid reference to aid well and sample identification

## Use

- Perfect for ABI® thermal cyclers & sequencers
- Recommended for low volume PCR
- Ideal for use with robotic systems
- Compatible with standard multichannel pipettes

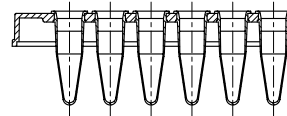

## Options

- Available with the following frame color options for the clear well variety: purple, blue, clear, green, red, and black
- Also available as a black frame with white wells for optimum signal-to-noise ratio when using fluorescent based assays
- Also available as a clear frame with frosted wells for use with ABI®/LifeTechnologies® qPCR instruments
- Ultra-low DNA binding option available (4ti-LB0770/C) for sensitive applications with ultra-low DNA input and for maximum DNA recovery after low temperature storage and high temperature incubation; learn more about our low binding range
- Ethylene oxide treated option available (4ti-OX770C/SBC) for forensic use
- Available barcoded upon request
- FrameStar 96 Lid (4ti-0289) available



## FrameStar 96 Well Semi-Skirted PCR Plate, ABI® Style

### Specifications

Parameter	Value
Plate length	124.26 ± 0.25 mm
Plate width	83.97 ± 0.25 mm
Plate height	20.70 ± 0.10 mm
Well depth	20.20 ± 0.10 mm
Well diameter	5.46 ± 0.10 mm
Distance to center of A1 from top edge	10.495 ± 0.25 mm
Distance to center of A1 from left edge	12.63 ± 0.25 mm
Pitch (distance between A1 and A2)	9.00 mm

### Ordering Information

4ti-0770	FrameStar 96 Well Semi-Skirted PCR Plate, ABI style, clear PP wells, purple PC frame, high profile, cut corner A12, 50 plates per case
4ti-0770/B	FrameStar 96 Well Semi-Skirted PCR Plate, ABI style, clear PP wells, blue PC frame, high profile, cut corner A12, 50 plates per case
4ti-0770/C	FrameStar 96 Well Semi-Skirted PCR Plate, ABI style, clear PP wells, clear PC frame, high profile, cut corner A12, 50 plates per case
4ti-0770/C/10P	FrameStar 96 Well Semi-Skirted PCR Plate, ABI style, clear PP wells, clear PC frame, high profile, cut corner A12, 10 plates per case
4ti-0770/G	FrameStar 96 Well Semi-Skirted PCR Plate, ABI style, clear PP wells, green PC frame, high profile, cut corner A12, 50 plates per case
4ti-0770/R	FrameStar 96 Well Semi-Skirted PCR Plate, ABI style, clear PP wells, red PC frame, high profile, cut corner A12, 50 plates per case
4ti-0770/X	FrameStar 96 Well Semi-Skirted PCR Plate, ABI style, clear PP wells, black PC frame, high profile, cut corner A12, 50 plates per case
4ti-0771	FrameStar 96 Well Semi-Skirted PCR Plate, ABI style, white PP wells, black PC frame, high profile, cut corner A12, 50 plates per case
4ti-0772	FrameStar 96 Well Semi-Skirted PCR Plate, ABI style, frosted PP wells, clear PC frame, high profile, cut corner A12, 50 plates per case
4ti-0772/10P	FrameStar 96 Well Semi-Skirted PCR Plate, ABI style, frosted PP wells, clear PC frame, high profile, cut corner A12, 10 plates per case
4ti-OX770C/SBC	FrameStar 96 Well Semi-Skirted PCR Plate, ABI style, clear PP wells, clear PC frame, with upstand, ethylene oxide treated, single barcoded, high profile, cut corner A12, 20 plates per case
4ti-LB0770/C	FrameStar 96 Well Semi-Skirted PCR Plate, ABI style, clear PP wells, clear PC frame, low binding, high profile, cut corner A12, 50 plates per case



# FrameStar 96 Well Semi-Skirted PCR Plate

High profile, 0.2 ml polypropylene wells, polycarbonate frame, cut corner H1, working volume: <200 µl, total well capacity: 300 µl; universal semi-skirted plate designed for use on standard thermal cyclers

- The rigid FrameStar 2-component design eliminates warping and distortion during PCR, making it ideal for use with robotic systems
- The semi-skirted allows for labeling or barcoding for sample tracking

## Key Features

- Free from DNase, RNase, human genomic DNA, and endotoxin/pyrogen

## Wells

- Ultra-smooth, uniform, thin-walled polypropylene tubes for optimum PCR and real-time (RT-qPCR) results
- <0.2 ml (200 µl) working volume, 0.3 ml (300 µl) total well capacity

## Frame

- Cut corner at H1
- Rigid polycarbonate frame for added mechanical stability
- Significantly reduced thermal expansion and sample evaporation for improved consistency in PCR results
- Improved seal integrity due to thermal stability of frame
- Alphanumeric grid reference to aid well and sample identification

## Use

- Recommended for low volume PCR
- Compatible with standard multichannel pipettes
- Ideal for use with robotic systems

## Options

- Also available with white wells for optimum signal-to-noise ratio when using fluorescent based assays
- Available barcoded upon request
- Similar plate with a cut corner at A12 for use with ABI® thermal cyclers and sequencers available: FrameStar 96 Well Semi-Skirted PCR Plate, ABI® Style

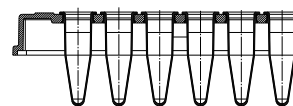
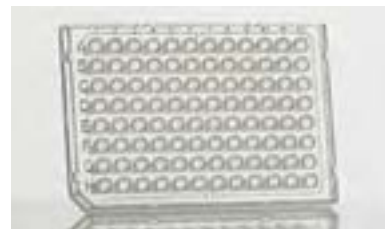

## Specifications

Parameter	Value
Plate length	127.76 ± 0.25 mm
Plate width	85.48 ± 0.25 mm
Plate height	20.70 ± 0.25 mm
Well depth	20.20 ± 0.10 mm
Well diameter	5.46 ± 0.10 mm
Distance to center of A1 from top edge	11.24 ± 0.25 mm
Distance to center of A1 from left edge	14.38 ± 0.25 mm
Pitch (distance between A1 and A2)	9.00 mm

## Ordering Information

<b>4ti-0900/C</b>	FrameStar 96 Well Semi-Skirted PCR Plate, clear PP wells, clear PC frame, high profile, cut corner H1, 50 plates per case
<b>4ti-0901</b>	FrameStar 96 Well Semi-Skirted PCR Plate, white PP wells, clear PC frame, high profile, cut corner H1, 50 plates per case

*For recommended plate options depending on manufacturer, block type, and instrument please refer to the Azenta Plate Instrument Compatibility Table Page 187.*

# FrameStar 96 Well Non-Skirted PCR Plate

High profile, 0.2 ml polypropylene wells, polycarbonate frame, cut corner H1, working volume: <200 µl, total well capacity: 300 µl; universal non-skirted plate designed for use on all major thermal cyclers

- The rigid FrameStar 2-component design eliminates warping and distortion during PCR, meaning seal integrity is not compromised and less of your sample is lost through evaporation

## Key Features

- Free from DNase, RNase, human genomic DNA, and endotoxin/pyrogen
- Greatest compatibility with different thermal cyclers

## Wells

- Ultra-smooth, uniform, thin-walled polypropylene tubes for optimum PCR and real-time (RT-qPCR) results
- <0.2 ml (200 µl) working volume, 0.3 ml (300 µl) total well capacity

## Frame

- Rigid polycarbonate frame for added mechanical stability
- Significantly reduced thermal expansion and sample evaporation for improved consistency in PCR results
- Improved seal integrity due to thermal stability of frame
- Alphanumeric grid reference to aid well and sample identification

## Use

- Recommended for low volume PCR
- Compatible with standard multichannel pipettes

## Options

- Available with the following frame color options for the clear well variety: purple, blue, clear, green, red, and black
- Also available as a black frame with white wells for optimum signal-to-noise ratio when using fluorescent based assays

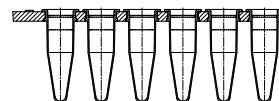
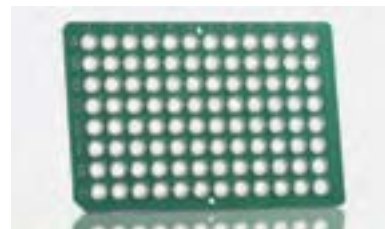

## Specifications

Parameter	Value
Plate length	120.00 ± 0.25 mm
Plate width	80.00 ± 0.25 mm
Plate height	20.70 ± 0.10 mm
Well depth	20.20 ± 0.10 mm
Well diameter	5.46 ± 0.10 mm
Distance to center of A1 from top edge	8.50 ± 0.25 mm
Distance to center of A1 from left edge	10.50 ± 0.25 mm
Pitch (distance between A1 and A2)	9.00 mm

## Ordering Information

4ti-0710	FrameStar 96 Well Non-Skirted PCR Plate, clear PP wells, purple PC frame, high profile, cut corner H1, 50 plates per case
4ti-0710/B	FrameStar 96 Well Non-Skirted PCR Plate, clear PP wells, blue PC frame, high profile, cut corner H1, 50 plates per case
4ti-0710/C	FrameStar 96 Well Non-Skirted PCR Plate, clear PP wells, clear PC frame, high profile, cut corner H1, 50 plates per case
4ti-0710/G	FrameStar 96 Well Non-Skirted PCR Plate, clear PP wells, green PC frame, high profile, cut corner H1, 50 plates per case
4ti-0710/R	FrameStar 96 Well Non-Skirted PCR Plate, clear PP wells, red PC frame, high profile, cut corner H1, 50 plates per case
4ti-0711	FrameStar 96 Well Non-Skirted PCR Plate, white PP wells, black PC frame, high profile, cut corner H1, 50 plates per case

For recommended plate options depending on manufacturer, block type, and instrument please refer to the Azenta Plate Instrument Compatibility Table Page 187.

# FrameStar 96 Well Non-Skirted PCR Plate, Low Profile

Low profile, 0.1 ml polypropylene wells, polycarbonate frame, cut corner H1, working volume: <100 µl, total well capacity: 200 µl; universal non-skirted, low profile plate designed for use on all major thermal cyclers

- The low profile wells of this plate are shorter than “standard” profile wells, which decrease the “dead space” between the heated lid of the thermal cycler and the sample in the well
- This eliminates condensation forming on the side wall of the tubes, preventing reduction in PCR volume and increasing the efficiency of the reaction
- This is especially recommended for reaction volumes below 20 µl
- The rigid polycarbonate skirt of this design eliminates warping and distortion during PCR, meaning seal integrity is not compromised and less of your sample is lost through evaporation

## Key Features

- Free from DNase, RNase, human genomic DNA, and endotoxin/pyrogen
- Greatest compatibility with different thermal cyclers

## Wells

- Ultra-smooth, uniform, thin-walled polypropylene tubes for optimum PCR and real-time (RT-qPCR) results
- <0.1 ml (100 µl) working volume, 0.2 ml (200 µl) total well capacity

## Frame

- Rigid polycarbonate frame for added mechanical stability
- Significantly reduced thermal expansion and sample evaporation for improved consistency in PCR results
- Improved seal integrity due to thermal stability of frame
- Alphanumeric grid reference to aid well and sample identification

## Use

- Recommended for low volume PCR
- Compatible with standard multichannel pipettes

## Options

- Available with the following frame color options for the clear well variety: purple, blue, and clear
- Also available as a black frame with white wells for optimum signal-to-noise ratio when using fluorescent based assays

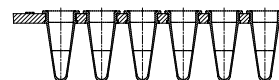

## Specifications

Parameter	Value
Plate length	120.00 ± 0.25 mm
Plate width	80.00 ± 0.25 mm
Plate height	15.60 ± 0.05 mm
Well depth	15.10 ± 0.10 mm
Well diameter	5.50 ± 0.10 mm
Distance to center of A1 from top edge	18.50 ± 0.25 mm
Distance to center of A1 from left edge	10.50 ± 0.25 mm
Pitch (distance between A1 and A2)	9.00 mm

## Ordering Information

<b>4ti-0720</b>	FrameStar 96 Well Non-Skirted PCR Plate, clear PP wells, purple PC frame, low profile, cut corner H1, 50 plates per case
<b>4ti-0720/B</b>	FrameStar 96 Well Non-Skirted PCR Plate, clear PP wells, blue PC frame, low profile, cut corner H1, 50 plates per case
<b>4ti-0720/C</b>	FrameStar 96 Well Non-Skirted PCR Plate, clear PP wells, clear PC frame, low profile, cut corner H1, 50 plates per case
<b>4ti-0721</b>	FrameStar 96 Well Non-Skirted PCR Plate, clear PP wells, black PC frame, low profile, cut corner H1, 50 plates per case

*For recommended plate options depending on manufacturer, block type, and instrument please refer to the Azenta Plate Instrument Compatibility Table Page 187.*

# FrameStar Vertically Breakable & Vertically and Horizontally Breakable PCR Plates



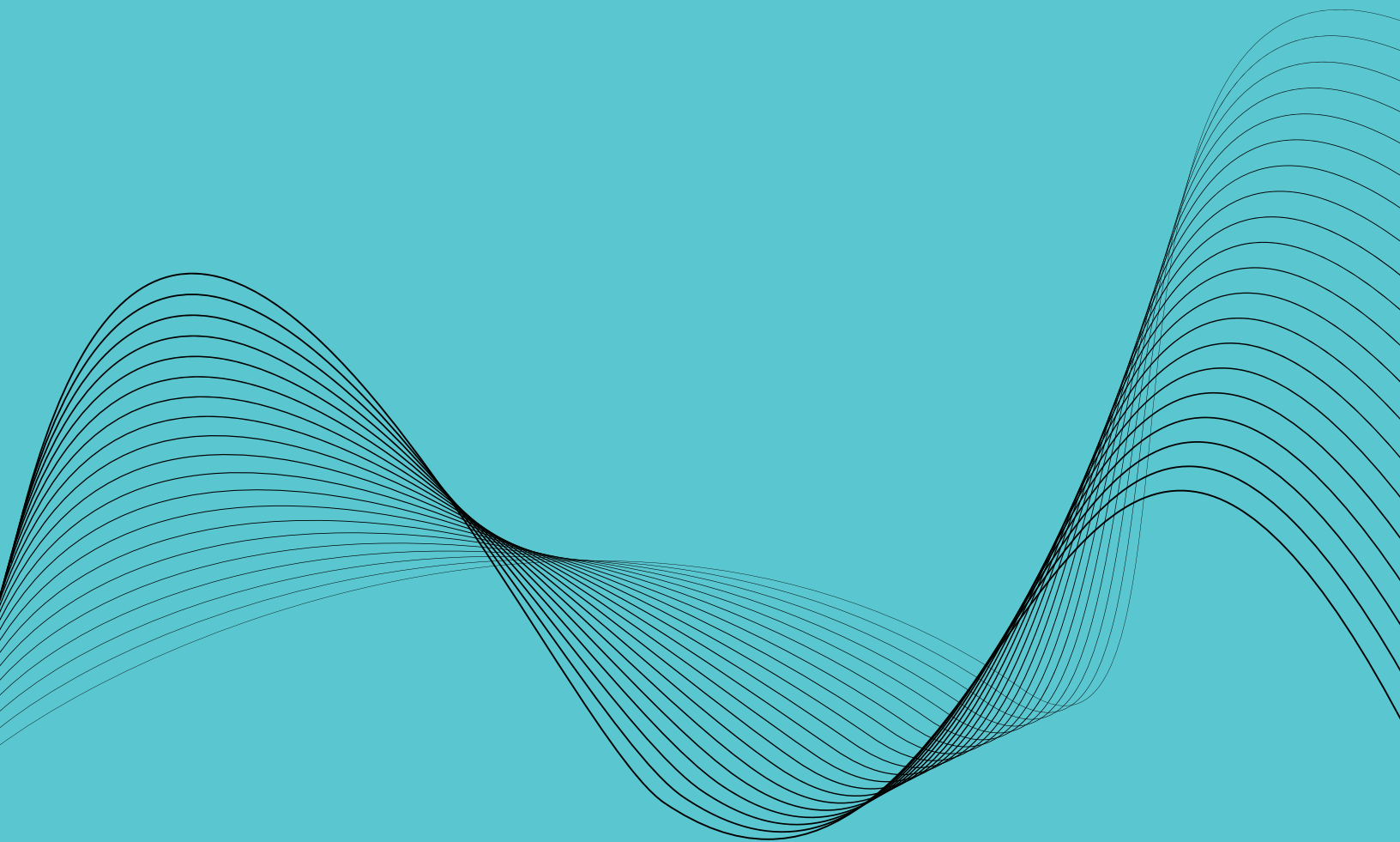

**AZENTA**  
LIFE SCIENCES

# FrameStar Breakable PCR Plates

## FrameStar Breakable PCR Plates

FrameStar Breakable PCR Plates can be easily divided into smaller plate sections, ensuring no tubes are wasted.

The plates combine the advantages of the FrameStar and 8 Well PCR Tube Strip with PC Frame range as well as single tube formats. The result is PCR consumables with thin-walled polypropylene (PP) tubes for optimal PCR results with a rigid polycarbonate frame for easy and reliable handling.

The two-component design minimizes evaporation allowing for the downscaling of reaction volumes and the breakability of the plates offers flexibility to suit your experiment size. Once broken down, strips remain straight and stable for ease of handling and to enable effortless sample tracking if 2D coded.

FrameStar Breakable PCR Plates - Division brings flexibility!

- Dividable vertically, or both vertically and horizontally
- Flexible solutions for every application
- Available as high and low profile plates to suit your reaction volume and instrument format
- Highest instrument compatibility
- Seven frame colors with clear or white tubes available
- Color coding for different workflows
- 2D coded options available
- Error-free sample tracking
- Plate segmentation can be automated
- Also available as pre-cut strips, see 8 Well PCR Tube Strip with PC Frame, page 157

## Sealing options

Plates can be sealed with standard heat or adhesive seals and then cut to produce individually sealed strips of wells.

Alternatively, perforated seals or Individual access seals can be used depending on individual tube, 8 or 12 well strips required. Please refer to [azenta.com](http://azenta.com) for information on semi-automated, fully automated and individual access heat sealers.



*FrameStar Vertically Breakable & Vertically and Horizontally Breakable PCR Plates can be easily divided into smaller plate sections, ensuring no tubes are wasted.*



*FrameStar Breakable PCR Plates offer you all the flexibility of tube strips, in a plate format*

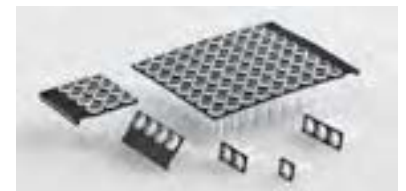

*FrameStar Breakable PCR Plates, dividable both horizontally and vertically*





# FrameStar Vertically Breakable PCR Plate



## High profile

0.2 ml PP wells, working volume:  
<200  $\mu$ l, total well capacity: 300  $\mu$ lAC

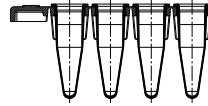

## Low profile

0.1 ml PP wells, working volume:  
<100  $\mu$ l, total well capacity: 200  $\mu$ l

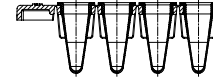

96 well semi-skirted plate, vertically scored, snaps easily into strips of 8 tubes or part plates, cut corner A12

- Our FrameStar Vertically Breakable PCR Plates utilize the 2-component design of the FrameStar range, which combines the advantages of thin-walled polypropylene tubes for optimum PCR results and a rigid frame portion for easy and reliable handling

## Key Features

- Free from DNase, RNase, human genomic DNA, and endotoxin/pyrogen
- 2-component design prevents distortion of tube strips

## Wells

- Ultra-smooth, uniform, thin-walled polypropylene tubes for optimum PCR and real-time (RT-qPCR) results
- Standard 0.2 ml (200  $\mu$ l) working volume, with a 0.3 ml (300  $\mu$ l) total well capacity when used with sealing options
- Low profile 0.1ml (100 $\mu$ l) working volume, with a 0.2ml (200 $\mu$ l) total well capacity when used with sealing options

## Frame

- End tabs for easy handling and labeling
- Eliminates strip breakage
- Alphanumeric grid reference to aid well and sample identification

## Use

- Rigid PCR plate that can be broken into smaller plate sections
- Fits majority of thermal cyclers
- Compatible with standard multichannel

## Options

- Available with the following frame color options for the clear well variety: purple, blue, clear, green, red, black, and white
- Also available as a black frame with white wells for use with optical assays such as qPCR
- 2D coding option
- 2D code reader available

## Specifications

Parameter	Value (High Profile)	Value (Low Profile)
Plate length	125.11 $\pm$ 0.25 mm	125.11 $\pm$ 0.25 mm
Plate width	83.22 $\pm$ 0.25 mm	83.22 $\pm$ 0.25 mm
Plate height	20.80 $\pm$ 0.05 mm	15.60 $\pm$ 0.25 mm
Well depth	20.30 $\pm$ 0.10 mm	15.10 $\pm$ 0.10 mm
Well diameter	5.46 $\pm$ 0.10 mm	5.50 $\pm$ 0.10 mm
Distance to center of A1 from top edge	10.11 $\pm$ 0.25 mm	10.11 $\pm$ 0.25 mm
Distance to center of A1 from left edge	13.06 $\pm$ 0.25 mm	13.06 $\pm$ 0.25 mm
Pitch (distance between A1 and A2)	9.00 mm	9.00 mm

2D coding is available for this product. Contact us for more information



**AZENTA**  
LIFE SCIENCES

## Ordering Information

### FrameStar Vertically Breakable PCR Plate High profile

<b>4ti-1000/P</b>	FrameStar 96 Well Semi-Skirted PCR Plate, clear PP wells, purple PC frame, vertically breakable, high profile, cut corner A12, 50 plates per case
<b>4ti-1000/B</b>	FrameStar 96 Well Semi-Skirted PCR Plate, clear PP wells, blue PC frame, vertically breakable, high profile, cut corner A12, 50 plates per case
<b>4ti-1000/C</b>	FrameStar 96 Well Semi-Skirted PCR Plate, clear PP wells, clear PC frame, vertically breakable, high profile, cut corner A12, 50 plates per case
<b>4ti-1000/G</b>	FrameStar 96 Well Semi-Skirted PCR Plate, clear PP wells, green PC frame, vertically breakable, high profile, cut corner A12, 50 plates per case
<b>4ti-1000/R</b>	FrameStar 96 Well Semi-Skirted PCR Plate, clear PP wells, red PC frame, vertically breakable, high profile, cut corner A12, 50 plates per case
<b>4ti-1000/X</b>	FrameStar 96 Well Semi-Skirted PCR Plate, clear PP wells, black PC frame, vertically breakable, high profile, cut corner A12, 50 plates per case
<b>4ti-1000/W</b>	FrameStar 96 Well Semi-Skirted PCR Plate, clear PP wells, white PC frame, vertically breakable, high profile, cut corner A12, 50 plates per case
<b>4ti-1001</b>	FrameStar 96 Well Semi-Skirted PCR Plate, white PP wells, black PC frame, vertically breakable, high profile, cut corner A12, 50 plates per case

### FrameStar Vertically Breakable PCR Plate Low profile

<b>4ti-1200/P</b>	FrameStar 96 Well Semi-Skirted PCR Plate, clear PP wells, purple PC frame, vertically breakable, low profile, cut corner A12, 50 plates per case
<b>4ti-1200/B</b>	FrameStar 96 Well Semi-Skirted PCR Plate, clear PP wells, blue PC frame, vertically breakable, low profile, cut corner A12, 50 plates per case
<b>4ti-1200/C</b>	FrameStar 96 Well Semi-Skirted PCR Plate, clear PP wells, clear PC frame, vertically breakable, low profile, cut corner A12, 50 plates per case
<b>4ti-1200/G</b>	FrameStar 96 Well Semi-Skirted PCR Plate, clear PP wells, green PC frame, vertically breakable, low profile, cut corner A12, 50 plates per case
<b>4ti-1200/R</b>	FrameStar 96 Well Semi-Skirted PCR Plate, clear PP wells, red PC frame, vertically breakable, low profile, cut corner A12, 50 plates per case
<b>4ti-1200/X</b>	FrameStar 96 Well Semi-Skirted PCR Plate, clear PP wells, black PC frame, vertically breakable, low profile, cut corner A12, 50 plates per case
<b>4ti-1200/W</b>	FrameStar 96 Well Semi-Skirted PCR Plate, clear PP wells, white PC frame, vertically breakable, low profile, cut corner A12, 50 plates per case
<b>4ti-1201</b>	FrameStar 96 Well Semi-Skirted PCR Plate, white PP wells, black PC frame, vertically breakable, low profile, cut corner A12, 50 plates per case

FrameStar Breakable PCR plates are not compatible with the ABI 9700 dual block thermal cycler.

For recommended plate options depending on manufacturer, block type, and instrument please refer to the Azenta Plate Instrument Compatibility Table Page 187.



# FrameStar Vertically and Horizontally Breakable PCR Plate

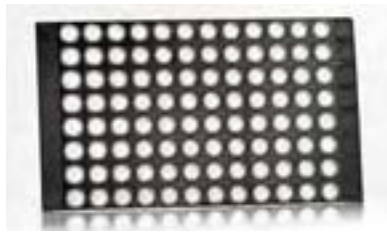

## High profile

0.2 ml PP wells, working volume:  
<200 µl, total well capacity: 300 µl

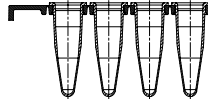

## Low profile

0.1 ml PP wells, working volume:  
<100 µl, total well capacity: 200 µl

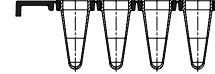

96 well rigid plate, vertically and horizontally scored, snaps easily into part plates, 8 well strips, 12 well strips, part strips or individual tubes

- Azenta's FrameStar Vertically and Horizontally Breakable PCR Plates allow for the most flexible, efficient and cost-effective use of FrameStar PCR plates, ensuring not a single tube is wasted
- Our Vertically and Horizontally Breakable PCR Plates utilize the 2-component design of the FrameStar range, which combines the advantages of thin-walled polypropylene tubes for optimum PCR results and a rigid frame portion for easy and reliable handling

## Key Features

- Free from DNase, RNase, human genomic DNA, and endotoxin/pyrogen

## Wells

- Ultra-smooth, uniform, thin-walled polypropylene tubes for optimum PCR and real-time (RT-qPCR) results
- Standard 0.2 ml (200 µl) working volume, with a 0.3 ml (300 µl) total well capacity when used with sealing options
- Low profile, 0.1ml wells, <100µl working volume, with a 200 µl total well capacity when used with sealing options

## Specifications

Parameter	Value (High Profile)	Value (Low Profile)
Plate length	125.00 ± 0.25 mm	125.00 ± 0.25 mm
Plate width	72.0 ± 0.25 mm	72.0 ± 0.25 mm
Plate height	20.70 ± 0.05 mm	15.60 ± 0.15 mm
Well depth	20.20 ± 0.10 mm	15.10 ± 0.15 mm
Well diameter	5.46 ± 0.10 mm	5.50 ± 0.10 mm
Distance to center of A1 from top edge	4.5 ± 0.25 mm	4.50 ± 0.25 mm
Distance to center of A1 from left edge	8.5 ± 0.25 mm	8.50 ± 0.25 mm
Pitch (distance between A1 and A2)	9.00 mm	9.00 mm

## Use

- Plates can be broken up in both 8-strip vertical and 12-strip horizontal directions, resulting in individual strips, part strips, or even individual tubes, giving you the highest range of flexibility
- Breaking a plate is more accurate, more convenient, and safer than cutting it with scissors, as it avoids damaging the sealing rings and contamination of the wells
- Plates can be filled, sealed and separated for storage, processing or distribution
- Easy to break at any temperature
- The plate can be adapted to individual pipetting schemes without the need to waste empty wells
- Separated strips or tubes can be used for the positive control to avoid contamination of the samples
- Compatible with all instruments that fit non-skirted, high profile plates
- NB: In some cases you may have to break off the end tabs for it to fit
- Compatible with standard multichannel pipettes

## Options

- 2D coding option
- 2D code reader available

## Ordering Information

4ti-1300/X	FrameStar 96 Well Semi-Skirted PCR Plate, clear PP wells, black PC frame, breakable vertically and horizontally, high profile, cut corner A12, 50 plates per case
4ti-1400/X	FrameStar 96 Well Semi-skirted PCR Plate, clear PP wells, black PC frame, breakable vertically and horizontally, low profile, cut corner A12, 50 plates per case

*In some cases it may be required to break off the end tabs to allow for a perfect fit.*

*For recommended plate options depending on manufacturer, block type, and instrument please refer to the Azenta Plate Instrument Compatibility Table Page 187.*

# Individual Access 96 Well PCR Plates



# FrameStar Individual Access 96 Well PCR Plates

FrameStar is our superior technology of making PCR plates with ultra-thin polypropylene wells fitted into a robust polycarbonate frame that provides excellent stability. Our Individual Access plates develop this technology further to supply a novel 96 well plate with individually removable wells combining both flexibility and robustness.

Individual Access plates provide flexibility and robustness to Molecular Diagnostics customers. 96 well plate format is suitable for high throughput reagents dispensing on liquid handling robots, while individually sealable and removable wells provide flexibility to end users to accommodate varying throughputs.

The wells are made from medical grade polypropylene which is perfectly suited for use in PCR as well as for long term storage. The exact number of wells required can be used, meaning no wastage of consumables or reagents. Empty frames are also available for tubes to be transferred to, however, frames can be re-used multiple times, depending on their application.

Each well clicks into place within the frame, holding it securely for use with automation and for transport. Additionally, the fit of the tubes is not compromised following a PCR run due to resistance of the rigid frame to thermal expansion.

- **SBS footprint** – suitable for automation
- **Rigid frame** – does not expand during PCR cycles allowing for individual tubes to fit tightly in the frame before and after PCR
- **PP wells** – low binding to nucleic acids and high solvent resistance, ideal for both PCR and storage
- **Thin walled tubes** – optimal heat transfer during PCR
- **Individually sealed using individual seals, specifically designed individual plates** – tubes can be filled, sealed and then single tubes removed
- **Tubes can be removed and inserted again** – ultimate flexibility

*Individual Access plates provide the greatest flexibility in PCR plates, affording handling of individual wells in a 96 well plate format.*



*Individual Access 96 Well Skirted PCR Plate*



# Individual Access 96 Well Skirted PCR Plates

Low profile, individually removable 0.1 ml polypropylene wells, rigid polycarbonate frame, cut corner H1, working volume: <100 µl, total well capacity: 200 µl

- 96 well, fully skirted, low profile format with each tube inserted separately into the plate frame, allowing for selection and removal of individual tubes from the plate
- Each tube clicks into place in the frame ensuring tubes are secure once inserted
- The rigid polycarbonate skirt of this design eliminates warping and distortion during PCR
- Together with the SBS footprint, this makes the plate suitable for use with robotic systems, ideal for both small to high throughput labs
- Empty frames are available for tubes to be transferred to
- The frames can be re-used multiple times, depending on the application

## Key Features

- Free from DNase, RNase, human genomic DNA, and endotoxin/pyrogen

## Tubes

- Individually removable from the rigid frame, while the rest of the tubes can remain in storage, reducing freeze-thawing of the whole plate
- Thin walled tubes are made from PP for optimal results in (q)PCR whilst also being suitable for storage and incubation
- <100 µl working volume, <200 µl total well capacity

## Frame

- Rigid polycarbonate frame provides mechanical stability of the plate
- Alphanumeric grid reference to aid well and sample identification

## Use

- Ideal for use with robotic systems
- Fewer transfer steps as the same tube can be used for both (q)PCR and storage
- Each tube can still be separated after sealing
- Each tube can be individually heat sealed using the Individual Access Pierce Heat Seal Strong, such as the contents of each tube is left secure from cross contamination and evaporation for storage and transfer

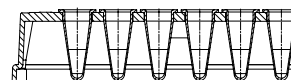

## Options

- Empty frames are available for tubes to be transferred to; frames can be re-used multiple times, depending on the application
- The plate can be sealed in one step using our range of Individual Access Heat Seals on our fully or semi-automated heat sealers (using the 4ti-0613 Individual Access adapter), resulting in individually sealed tubes with pierceable seals to allow for sample access
- Available barcoded upon request
- We also offer customization of the Individual Access Plates such as color coding of the individual wells; please contact us for details

## Specifications

Parameter	Value
Plate length	127.76 ± 0.25 mm
Plate width	85.48 ± 0.25 mm
Plate height	15.50 ± 0.25 mm
Well depth	15.10 ± 0.10 mm
Well diameter	5.50 ± 0.10 mm
Distance to center of A1 from top edge	11.24 ± 0.25 mm
Distance to center of A1 from left edge	14.38 ± 0.25 mm
Pitch (distance between A1 and A2)	9.00 mm

## Ordering Information

4ti-0960/RA	Individual Access 96 Well Skirted PCR Plate, clear PP wells, white rigid PC frame, individually removable wells, low profile, cut corner H1, 50 plates per case
4ti-0960/RA/F	Individual Access 96 Well Skirted PCR Plate Frame, for individually removable wells, white rigid PC frame, cut corner H1, 10 frames per case

For recommended plate options depending on manufacturer, block type, and instrument please refer to the Azenta Plate Instrument Compatibility Table Page 187.

# Individual Access 96 Well Skirted Optical Bottom PCR Plates

**Low profile, flat optical bottom, 0.1 ml clear polypropylene tubes, black rigid polycarbonate frame, cut corner H1, working volume: <100 µl, total well capacity: 180 µl**

- 96 well, fully skirted, low profile format with each tube inserted separately into the plate frame, allowing for selection and removal of individual tubes from the plate
- Each tube clicks into place in the frame ensuring tubes are secure once inserted
- The Individual Access 96 Well Skirted Optical Bottom PCR Plates (next to their counterpart within our FrameStar range, 4ti-0970) are currently unique in the market, being suitable for use in both microscopy and PCR, for example, when single cell sorting is followed by molecular biology applications such as qPCR and sequencing
- Due to their flat bottoms and stackability, these plates are well suited for small sample volume storage (such as compound libraries), with no risk of damaging the seal of the plate below
- Additionally, the small well volume enables excellent sample recovery
- The rigid polycarbonate skirt of this design eliminates warping and distortion during PCR
- Together with the SBS footprint, this makes the plate suitable for use with robotic systems, ideal for both small and high-throughput labs
- Empty frames are available for tubes to be transferred to. The frames can be re-used multiple times, depending on the application

## Key Features

- Free from DNase, RNase, human genomic DNA, and endotoxin/pyrogen

## Tubes

- Individually removable from the rigid frame, while the rest of the tubes can remain in storage, reducing freeze-thawing of the whole plate
- Thin walled tubes are made from PP for optimal results in (q)PCR whilst also being suitable for storage and incubation
- <100 µl working volume, <180 µl total well capacity

## Frame

- Rigid polycarbonate frame provides mechanical stability of the plate
- Alphanumeric grid reference to aid well and sample identification

## Use

- Suitable for microscopy and small volume sample storage
- Ideal for use with robotic systems
- Fewer transfer steps as the same tube can be used for microscopy, (q)PCR and storage
- Each tube can still be separated after sealing

*For recommended plate options depending on manufacturer, block type, and instrument please refer to the Azenta Plate Instrument Compatibility Table Page 187.*



- Each tube can be individually heat sealed using the Individual Access Pierce Heat Seal Strong, such as the contents of each tube is left secure from cross contamination and evaporation for storage and transfer

## Options

- Also available as a FrameStar plate (4ti-0970) with fixed wells
- Empty frames are available for tubes to be transferred to; frames can be re-used multiple times, depending on the application
- We also offer customization of the Individual Access Plates such as color coding of the individual wells; please contact us for details
- Available barcoded upon request, please contact us for details
- The plate can be sealed in one step using our range of Individual Access Heat Seals on our Automated Individual Access Heat Sealer (see page 244) or our Semi-Automated Sheet Heat Sealer (see page 246) (using the 4ti-0613 Individual Access adapter), resulting in individually sealed tubes with pierceable seals to allow for sample access

## Specifications

Parameter	Value
Plate length	127.76 ± 0.25 mm
Plate width	85.48 ± 0.25 mm
Plate height	15.50 ± 0.25 mm
Well depth	12.00 ± 0.10 mm
Well diameter	5.46 ± 0.10 mm
Distance to center of A1 from top edge	11.24 ± 0.25 mm
Distance to center of A1 from left edge	14.38 ± 0.25 mm
Pitch (distance between A1 and A2)	9.00 mm

## Ordering Information

<b>4ti-0970/RA</b>	Individual Access 96 Well Skirted Optical Bottom PCR Plate, clear PP wells, black PC frame, individually removable wells, low profile, cut corner H1, 50 plates per case
<b>4ti-0970/RA/F</b>	Individual Access 96 Well Skirted PCR Plate Frame, for individually removable wells, black rigid PC frame, cut corner H1, 10 frames per case



**AZENTA**  
LIFE SCIENCES

# Individually Removable Well 96 Well Skirted Flat Bottom PCR Plate, 2D Coded

**Low profile, flat bottom 2D coded, 0.1 ml clear polypropylene tubes, white rigid polycarbonate frame, linear barcoded, cut corner H1, working volume: <100 µl, total well capacity: 180 µl**

- 96 well, fully skirted, low profile format with each tube inserted separately into the plate frame, allowing for selection and removal of individual tubes from the plate
- Each tube clicks into place in the frame ensuring tubes are secure once inserted
- We have now extended our Individual Access range to include PCR plates with 2D coded flat bottoms for applications that require superior sample tracking
- In applications where it is essential for samples to be tracked throughout their processing, e.g. for diagnostic assays on clinical samples, tube labeling is a far safer and reliable method compared to cap or seal labeling (which can be misplaced, damaged or rendered unreadable after piercing)
- Our plates have a unique 2D code printed on the bottom of the well and a linear barcode on the side of the plate to allow for identification of both the plate and individual tubes within
- The rigid polycarbonate skirt of this design eliminates warping and distortion during PCR
- Together with the SBS footprint, this makes the plate suitable for use with robotic systems, ideal for both small and high throughput labs
- Empty frames are available for tubes to be transferred to
- The frames can be re-used multiple times, depending on the application
- Sample tubes can be identified by the unique 2D code on the base of the wells, removed from the Individual Access plate quickly and easily, and moved to another Individual Access frame for downstream processing or storage
- Quick selection of desired tubes reduces the time needed for the sample plate to be out of the freezer and therefore reduces the chance of other wells defrosting in the meantime
- Flat bottom PCR plates can be stacked, allowing for optimal use of freezer space as multiple plates can be housed in the same space as a storage rack
- The 2D codes on the bottom of the wells can be read by most 2D data-matrix readers including Azenta Rack Readers
- The codes are highly scratch resistant and can withstand cold storage (-80°C), temperatures up to 100°C and solvents such as DMSO
- 2D data-matrix codes utilize data redundancy so even if codes are partly destroyed, the information will still be retained
- Each code is tested for readability and guaranteed to be unique



## Key Features

- Free from DNase, RNase, human genomic DNA, and endotoxin/pyrogen

## Tubes

- Individually removable from the rigid frame, while the rest of the tubes can remain in storage, reducing freeze-thawing of the whole plate
- Thin walled tubes are made from PP for optimal results in (q)PCR whilst also being suitable for storage and incubation
- <100 µl working volume, <180 µl total well capacity

## Frame

- Rigid polycarbonate frame provides mechanical stability of the plate
- These plates are labeled with linear Code 128-format barcodes to aid identification and traceability for your samples
- Alphanumeric grid reference to aid well and sample identification



**AZENTA**  
LIFE SCIENCES



# Individually Removable Well 96 Well Skirted Flat Bottom PCR Plate, 2D Coded

## Use

- Suitable for small volume sample storage, allowing for optimal use of freezer space as multiple plates can be housed in the same space as a storage rack
- Ideal for use with robotic systems
- Fewer transfer steps as the same tube can be used for microscopy, (q)PCR and storage
- Each tube can be individually heat sealed using the Individual Access Pierce Heat Seal Strong, such as the contents of each tube is left secure from cross contamination and evaporation for storage and transfer
- Each tube can still be separated after sealing

## Options

- Also available as a Individual Access optical bottom plate (4ti-0970/RA) with black frame, ideal for microscopy and PCR
- Empty frames are available for tubes to be transferred to; frames can be re-used multiple times, depending on the application
- We also offer customization of the Individual Access Plates such as color coding of the individual wells; please contact us for details
- The plate can be sealed in one step using our range of Individual Access Heat Seals on our Automated Individual Access Heat Sealer (see page 244) or on our Semi-Automated Sheet Heat Sealer (see page 246) (using the 4ti-0613 Individual Access adapter), resulting in individually sealed tubes with pierceable seals to allow for sample access

## Specifications

Parameter	Value
Plate length	127.76 ± 0.25 mm
Plate width	85.48 ± 0.25 mm
Plate height	15.50 ± 0.25 mm
Well depth	12.00 ± 0.10 mm
Well diameter	5.46 ± 0.10 mm
Distance to center of A1 from top edge	11.24 ± 0.25 mm
Distance to center of A1 from left edge	14.38 ± 0.25 mm
Pitch (distance between A1 and A2)	9.00 mm
Code	
Size	12 x 12 px; 2 x 2 mm
Format	white on black
Content	8 digit numeric

## Ordering Information

<b>4ti-0975/RA</b>	<b>Individual Access 96 Well Skirted Flat Bottom PCR Plate, clear PP wells, white PC frame, individually removable wells, 2D coded, low profile, cut corner H1, 50 plates per case</b>
<b>4ti-0960/RA/F</b>	<b>Individual Access 96 Well Skirted PCR Plate Frame, for individually removable wells, white rigid PC frame, cut corner H1, 10 frames per case</b>

*\*Please note, /SBC must be added to 4ti-0960/RA-F to include a standard single barcode.*

*For recommended plate options depending on manufacturer, block type, and instrument please refer to the Azenta Plate Instrument Compatibility Table Page 187.*

# Individual Access 96 Well Non-Skirted PCR Plate

Low profile, individually removable 0.1 ml polypropylene wells, rigid polycarbonate frame, non-skirted, cut corner H1, working volume: <100 µl, total well capacity: 200 µl

- 96 well, fully skirted, low profile format with each tube inserted separately into the plate frame, allowing for selection and removal of individual tubes from the plate.
- Each tube clicks into place in the frame ensuring tubes are secure once inserted
- The rigid polycarbonate skirt of this design eliminates warping and distortion during PCR
- SBS footprint,
- When used with Non-Skirted PCR Plate Adapter (4ti-0373), it is suitable for use with robotic systems
- Empty frames are available for tubes to be transferred to
- The frames can be re-used multiple times, depending on the application



## Specifications

Parameter	Value
Format	96 Well
Plate length	120.00 ± 0.20 mm
Plate width	80.00± 0.20 mm
Plate height	15.60 mm
Well diameter	5.50 mm
Color (frame)	White
Color (tube)	Clear

## Ordering Information

<b>4ti-0720/RA</b>	<b>Individual Access 96 Well Non-Skirted PCR Plate, clear PP individually removable wells, white PC frame, low profile, cut corner H1, 50 plates per case</b>
--------------------	---

*For recommended plate options depending on manufacturer, block type, and instrument please refer to the Azenta Plate Instrument Compatibility Table Page 187.*

# Individual Access Sealing Options

## Semi-Automated Individual Access Heat Sealing

The 96 well Individual Access plate can be sealed in one step using Individual Access seals. These seals result in individually sealed tubes that can be pierceable, allowing for sample access.

Individual Access Heat Seals are currently available in sheet format for use with the Semi-Automated Sheet Heat Sealer (using the 59-2005 Individual Access adapter).

Individual Access Sealing Procedure using the Semi-Automated Sheet Heat Sealer (59-2000)

1. Place adapter in open drawer of Sealer
2. Place Individual Access Plate on adapter
3. Place Individual Access Seal onto the plate
4. Plate is automatically sealed, remove plate
5. Remove the backing liner from the seal



## Automated Individual Access Heat Sealing

The roll-fed Automated Individual Access Heat Sealer allows for automatic sealing of Individual Access plates using Individual Access Heat Seal rolls.

The roll with the indexed groups of 96 individual sealing discs is automatically fed through the heat sealer. The accurate sealing is controlled by a sensor which gets activated by optical windows in the material feed, but can also be adjusted. Sealing temperature, time of sealing and exit delay (for cooling) can be controlled via the instrument's touchscreen.

Custom versions of instrument and sealing material are possible.

## Cap Mats for PCR Plates

- 96 individual caps in sheet format, blue TPE, pierceable; suitable for sealing all of our 96 well PCR plates
- The caps can be individually applied and removed once detached from the backing liner, making the mats ideally suited for use with our flexible PCR consumables, including Individual Access and divisible plates
- The mats offer an alternative to adhesive and heat sealing, in particular as a temporary solution when samples need to be repeatedly accessed
- They are easily pierceable with pipette tips to access samples, and they are easily removable using 1- and 8-way decappers or, alternatively, using the Azenta Automated Plate Seal Remover if a seal is overlaid on top of the caps



### Ordering Information

#### Semi-Automated Individual Access Heat Sealing

59-2000	Semi-Automated Sheet Heat Sealer, includes adapter (59-2001)
59-2005	Semi-Automated Sheet Heat Sealer Adapter, for Individual Access plates, 1 adapter per case
4ti-05381/RA	Individual Access Pierce Heat Seal Strong, strong heat sealing foil, 96 individual seals in sheet format, 100 sheets (127 x 100mm) per case
4ti-0531/RA	Individual Access Pierce Heat Seal, pierceable heat sealing foil, 96 individual seals in sheet format, 100 sheets (127 x 100mm) per case
4ti-0521/RA-TAB	Individual Access Peel Heat Seal, with tabs, peelable heat sealing foil, 96 individual seals with tabs, sheet format, 100 sheets (127 x 100mm) per case
4ti-0521/RA-8	Individual Access Peel Heat Seal, peelable heat sealing foil, 12 strips, each covering 8 wells, sheet format, 100 sheets (127 x 100mm) per case
4ti-0960/RA	Individual Access 96 Well Skirted PCR Plate, clear PP wells, white rigid PC frame, individually removable wells, low profile, cut corner H1, 50 plates per case
4ti-0753/757	96 Well Skirted PCR Plate with Removable 8 Well Strips, white PP wells, white PC frame, low profile, 50 plates per case
4ti-1200/P	FrameStar 96 Well Semi-Skirted PCR Plate, clear PP wells, purple PC frame, breakable vertically, low profile, cut corner A12, 50 plates per case
4ti-1400/X	FrameStar 96 Well Semi-skirted PCR Plate, clear PP wells, black PC frame, breakable vertically and horizontally, low profile, cut corner A12, 50 plates per case

#### Automated Individual Access Heat Sealing

59-1000	Automated Individual Access Roll Heat Sealer, for heat sealing of individual tubes or custom shaped consumables, for use with individual seals in roll format, includes adapter A (59-1004)
4ti-0539/RA	Individual Access Pierce Heat Seal Strong, strong heat sealing foil, 96 individual seals in roll format, 1 roll (420m x 100mm)
4ti-0532/RA	Individual Access Pierce Heat Seal, pierceable heat sealing foil, 96 individual seals in roll format, 1 roll (420m x 100mm)
4ti-0522/RA-TAB	Individual Access Peel Heat Seal, with tabs, peelable heat sealing foil, 96 individual seals with tabs, roll format, 1 roll (420m x 100mm)
4ti-0522/RA-8	Individual Access Peel Heat Seal, peelable heat sealing foil, 12 strips of 8 individual seals in roll format, 1 roll (420m x 100mm)
4ti-0960/RA	Individual Access 96 Well Skirted PCR Plate, clear PP wells, white rigid PC frame, individually removable wells, low profile, cut corner H1, 50 plates per case
4ti-0753/757	96 Well Skirted PCR Plate with Removable 8 Well Strips, white PP wells, white PC frame, low profile, 50 plates per case
4ti-1200/P	FrameStar 96 Well Semi-Skirted PCR Plate, clear PP wells, purple PC frame, breakable vertically, low profile, cut corner A12, 50 plates per case
4ti-1400/X	FrameStar 96 Well Semi-skirted PCR Plate, clear PP wells, black PC frame, breakable vertically and horizontally, low profile, cut corner A12, 50 plates per case



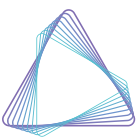

**AZENTA**  
LIFE SCIENCES

# PCR Tubes & Strips

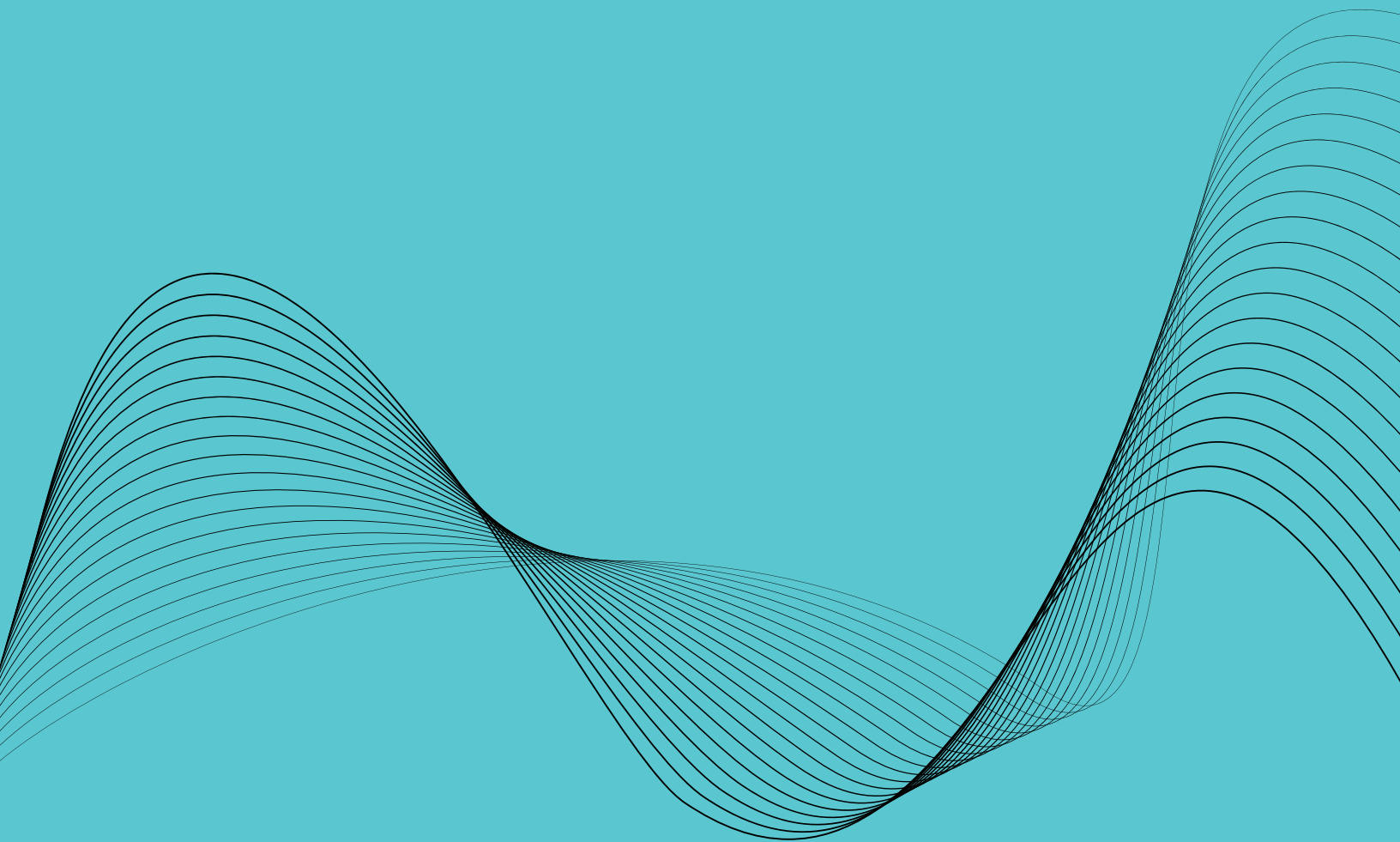

# PCR Tubes & Strips

Strips of 8, clear polypropylene PCR tubes (0.2 mL or 0.1 mL) held in a rigid polycarbonate frame.

By molding the frame portion in a more rigid polymer, the mechanical stability is greatly improved compared with traditional single piece products, as seen here.

For color coding of experiments, we offer strips with clear wells in 6 different frame colors. Additionally, for optical assays such as qPCR, we supply strips with white wells in black frames. White wells increase the signal-to-noise ratio by maximizing reflection of light in fluorescent based assays.

PCR Tubes & Strips are available either with cap strips (domed or optically flat) or without cap strips, and are compatible with the majority of thermal cyclers. End tabs allow for easy handling and labelling of the strips and some products are also available with an off-the-shelf 2D code, offering a vast supply of unique code combinations.

## 8 Well PCR Tube Strips

### Features

- 2-component design in an 8 well strip format
- Compatible with the majority of thermal cyclers
- Available with either domed cap strips or with flat, optically clear cap strips
- Available with off-the-shelf 2D code

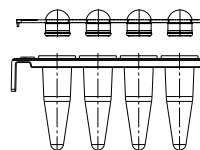

8 Well PCR Tube Strips,  
Plus Strips of Domed Caps

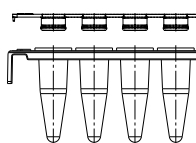

8 Well PCR Tube Strips, Plus  
Strips of Flat Optical Caps



8 Well PCR Tube Strips,  
Low Profile

8 Well PCR Tube Strips feature a rigid polycarbonate frame for highest mechanical stability



Unlike standard tube strips, the PCR Tubes & Strips will remain straight and stable, even at elevated temperatures and when filled with liquid.

## Ordering Information

### High profile + Domed Caps

4ti-0785/P	8 Well PCR Tube Strips, clear PP wells, purple PC frame, high profile, plus strips of domed caps, 120 tube strips and cap strips per case
4ti-0785/G	8 Well PCR Tube Strips, clear PP wells, green PC frame, high profile, plus strips of domed caps, 120 tube strips and cap strips per case
4ti-0785/B	8 Well PCR Tube Strips, clear PP wells, blue PC frame, high profile, plus strips of domed caps, 120 tube strips and cap strips per case
4ti-0785/R	8 Well PCR Tube Strips, clear PP wells, red PC frame, high profile, plus strips of domed caps, 120 tube strips and cap strips per case
4ti-0785/X	8 Well PCR Tube Strips, clear PP wells, black PC frame, high profile, plus strips of domed caps, 120 tube strips and cap strips per case
4ti-0785/X/2D	8 Well PCR Tube Strips, clear PP wells, black PC frame, 2D coded, high profile, plus strips of domed caps, 120 tube strips and cap strips per case
4ti-0785/W/2D	8 Well PCR Tube Strips, clear PP wells, white PC frame, 2D coded, high profile, plus strips of domed caps, 120 tube strips and cap strips per case
4ti-0785/XW	8 Well PCR Tube Strips, white PP wells, black PC frame, high profile, plus strips of domed caps, 120 tube strips and cap strips per case
4ti-0785/M	8 Well PCR Tube Strips, clear PP wells, assorted colors PC frame, high profile, plus strips of domed caps, 120 tube strips and cap strips per case
4ti-0785/C	8 Well PCR Tube Strips, clear PP wells, clear PC frame, high profile, plus strips of domed caps, 120 tube strips and cap strips per case

For recommended plate options depending on manufacturer, block type, and instrument please refer to the Azenta Plate Instrument Compatibility Table Page 187.



**AZENTA**  
LIFE SCIENCES

## 8 Well PCR Tube Strips

### Ordering Information

#### High profile + Flat Caps

<b>4ti-0786/P</b>	8 Well PCR Tube Strips, clear PP wells, purple PC frame, plus strips of flat caps, high profile, 120 tube strips and cap strips per case
<b>4ti-0786/G</b>	8 Well PCR Tube Strips, clear PP wells, green PC frame, plus strips of flat caps, high profile, 120 tube strips and cap strips per case
<b>4ti-0786/B</b>	8 Well PCR Tube Strips, clear PP wells, blue PC frame, high profile, plus strips of flat caps, 120 tube strips and cap strips per case
<b>4ti-0786/R</b>	8 Well PCR Tube Strips, clear PP wells, red PC frame, plus strips of flat caps, high profile, 120 tube strips and cap strips per case
<b>4ti-0786/X</b>	8 Well PCR Tube Strips, clear PP wells, black PC frame, plus strips of flat caps, high profile, 120 tube strips and cap strips per case
<b>4ti-0786/X/2D</b>	8 Well PCR Tube Strips, clear PP wells, black PC frame, plus strips of flat caps, high profile, 2D coded, 120 tube strips and cap strips per case
<b>4ti-0786/W/2D</b>	8 Well PCR Tube Strips, clear PP wells, white PC frame, plus strips of flat caps, high profile, 2D coded, 120 tube strips and cap strips per case
<b>4ti-0786/XW</b>	8 Well PCR Tube Strips, white PP wells, black PC frame, plus strips of flat caps, high profile, 120 tube strips and cap strips per case
<b>4ti-0786/M</b>	8 Well PCR Tube Strips, clear PP wells, assorted colors PC frame, plus strips of flat caps, high profile, 120 tube strips and cap strips per case
<b>4ti-0786/C</b>	8 Well PCR Tube Strips, clear PP wells, clear PC frame, high profile, plus strips of flat caps, 120 tube strips and cap strips per case

For recommended plate options depending on manufacturer, block type, and instrument please refer to the Azenta Plate Instrument Compatibility Table Page 187.

#### Low Profile (no caps)

<b>4ti-0789/B</b>	8 Well PCR Tube Strips, clear PP wells, blue PC frame, low profile, 120 tube strips per case
<b>4ti-0789/XW</b>	8 Well PCR Tube Strips, white PP wells, black PC frame, low profile, 120 tube strips per case
<b>4ti-0789/W</b>	8 Well PCR Tube Strips, clear PP wells, white PC frame, low profile, 120 tube strips per case

#### High profile (no caps)

<b>4ti-0775/P</b>	8 Well PCR Tube Strips, clear PP wells, purple PC frame, high profile, 120 tube strips per case
<b>4ti-0775/G</b>	8 Well PCR Tube Strips, clear PP wells, green PC frame, high profile, 120 tube strips per case
<b>4ti-0775/B</b>	8 Well PCR Tube Strips, clear PP wells, blue PC frame, high profile, 120 tube strips per case
<b>4ti-0775/R</b>	8 Well PCR Tube Strips, clear PP wells, red PC frame, high profile, 120 tube strips per case
<b>4ti-0775/X</b>	8 Well PCR Tube Strips, clear PP wells, black PC frame, high profile, 120 tube strips per case
<b>4ti-0775/X/2D</b>	8 Well PCR Tube Strips, clear PP wells, black PC frame, 2D coded, high profile, 120 tube strips per case
<b>4ti-0775/W/2D</b>	8 Well PCR Tube Strips, clear PP wells, white PC frame, 2D coded, high profile, 120 tube strips per case
<b>4ti-0775/XW</b>	8 Well PCR Tube Strips, white PP wells, black PC frame, high profile, 120 tube strips per case
<b>4ti-0775/M</b>	8 Well PCR Tube Strips, clear PP wells, assorted color PC frame, high profile, 120 tube strips per case
<b>4ti-0775/C</b>	8 Well PCR Tube Strips, clear PP wells, clear PC frame, high profile, 120 tube strips per case





# 8 Well PCR Tube Strip with PC Frame Adapter Lid

A 96 format frame that fits both 8 Well PCR Tube Strips and FrameStar Breakable plates, enabling our flexible PCR consumables to be handled in SBS format; ideal for use in automated or manual manufacturing processes.

Grippers on a robotic deck grip the 8 Well PCR Tube Strip adapter, allowing it to be handled as if it were a plate. The high profile Tube Strips have a push fit with the adapter, ensuring they are held within the plate and do not move around or fall out during handling, thereby ensuring samples are secure throughout the lifecycle.

- SBS footprint for use with robotics – loaded frames can be handled by robotics, increasing efficiency and accuracy during kit assembly
- Dedicated lid with interference fit – samples are securely protected avoiding damage to kits during transport
- Interference fit with high profile tubes – tubes are stable in the frame making them easier to handle and reducing the chance of errors when used with robotics
- Full Breakable plates or individual 8 Well PCR Tube Strips – suitable for use in both high and low throughput environments
- Ability to 2D code end tabs – sample can be tracked from kit manufacture all the way to processing at the end user site
- Locator pins on the deck ensure 8 Well PCR Tube Strips are always loaded in the correct orientation
- Reduces human error
- Adapters can be customized into different colors for custom/OEM opportunities.

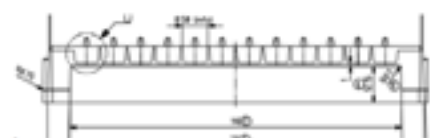

**Important note: the adapters cannot be placed directly into PCR cyclers due to the height of the skirt. These adapters are designed to provide an automation friendly strip/plate support during processing, after which, the strips/plates can be removed from the adapter and placed into a PCR block.**

## Specification Adapter

Feature	Information
Format	96 well
Length	127.76mm ± 0.25mm
Width	85.48mm ± 0.25mm
Height (without lid)	21.25mm
Height (with lid)	24.00mm
Color (adapter)	White
Color (lid)	Clear

## Ordering Information

<b>4ti-0370</b>	<b>8 Well PCR Tube Strip Adapter, 96 well skirted frame, with lid, white PC, cut corner H1, 18 adapters and lids per case</b>
<b>4ti-0371</b>	<b>8 Well PCR Tube Strip Adapter, 96 well skirted frame, white PC, cut corner H1, 18 adapters per case</b>
<b>4ti-0292</b>	<b>8 Well PCR Tube Strip Adapter Lid, without condensation rings, clear PS, low profile, no cut corner, 10 lids per case</b>

# Non-Skirted PCR Plate Adapter

A 96 format frame that fits non-skirted PCR plates to allow for easy handling and use with automation.

- Cost and space saving design
- Clear polycarbonate
- Universal fit with non-skirted PCR plates
- Compatible with the Universal Microplate Lid
- Non-skirted PCR plates have the widest application range, fitting most cyclers
- However, they don't offer the same level of compatibility with robotic platforms and are not as multichannel pipetting friendly as fully- or semi-skirted plates are
- The Azenta Non-Skirted PCR Plate Adapter was developed to address all that, improving the overall ease of use of non-skirted plates
- Azenta adapters are manufactured in class 7 ISO certified cleanroom, and all lids are certified free of DNase, RNase, human DNA, bacterial and eukaryotic cells, dust and endotoxins/pyrogens



## Key Features

- Accommodates both low and high profile non-skirted plates
- No locator pins, ensuring compatibility with all non-skirted plates and tubestrips
- Compatible with the Universal Microplate Lid, for a quick and easy sealing solution to protect samples from contamination and evaporation

## Specification Non-Skirted PCR Plate Adapter

Feature	Information
Format	96 well
Length	127.76mm ± 0.25mm
Width	85.48mm ± 0.25mm
Height (without lid)	21.2mm
Height (with lid)	24.00mm
Color	Clear

## Ordering Information

<b>4ti-0373</b>	<b>Non-Skirted PCR Plate Adapter</b> , 96 well skirted frame, clear PC, cut corner H1, 18 adapters per case
<b>Combi Pack</b>	
<b>4ti-0372</b>	<b>Non-Skirted PCR Plate Adapter</b> , 96 well skirted frame, <b>with lid</b> , clear PC, cut corner H1, 18 adapters and lids per case
<b>Compatible lids</b>	
<b>4ti-0290</b>	<b>Universal Microplate Lid</b> , without condensation rings, clear, low profile, no cut corner, 50 lids per case





**AZENTA**  
LIFE SCIENCES

# 96 Well PCR Plates with 8 Well Removeable Tube Strips



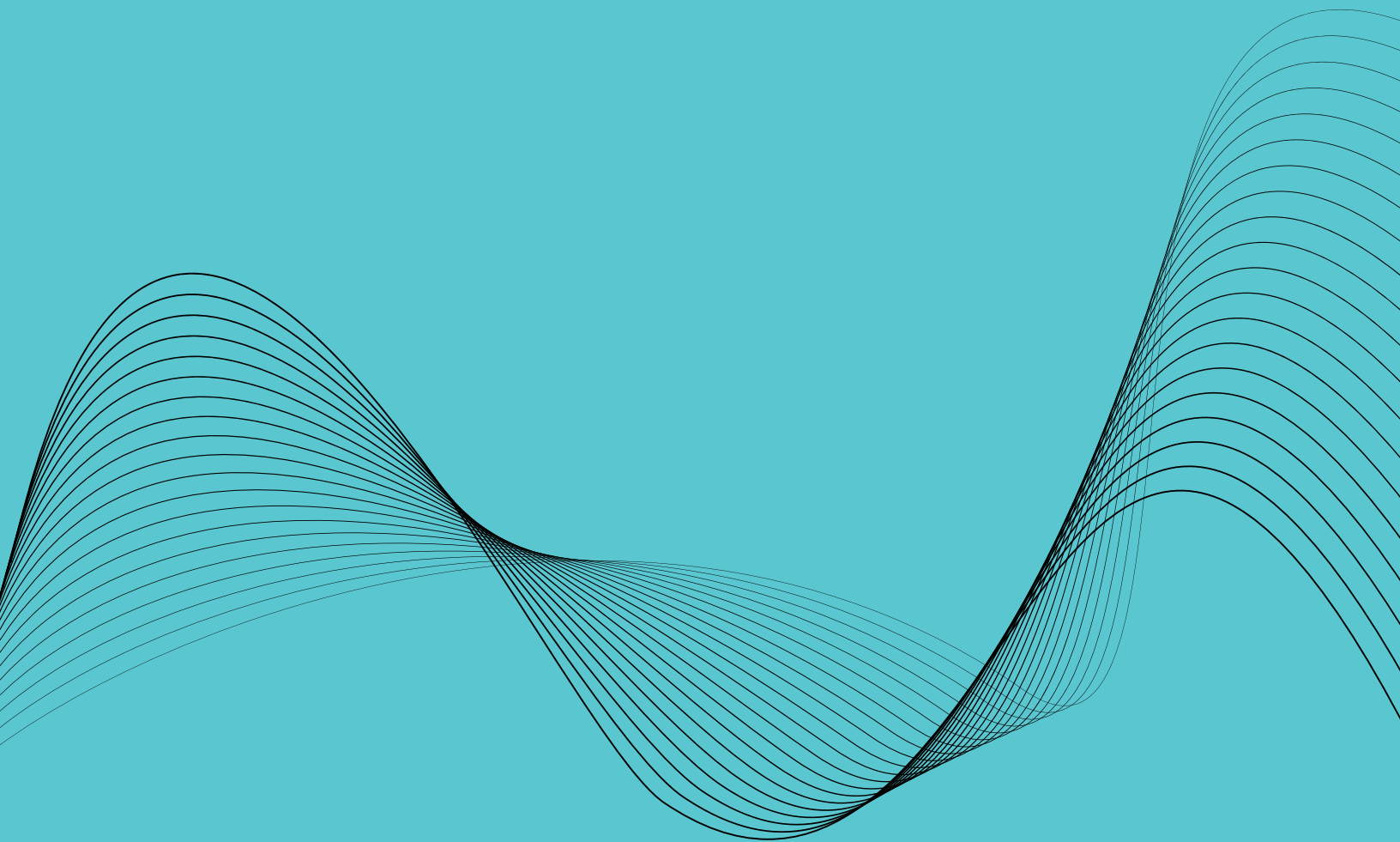

**AZENTA**  
LIFE SCIENCES

# 96 Well PCR Plates with 8 Well Removeable Tube Strips

## PCR tube strips in frames - excellent flexibility

The 96 Well PCR Plates with 8 Well Removeable Tube Strip system offers total flexibility in plate usage. It allows the user to insert or remove strips of 8 tubes from a 96 well plate frame.

- 8 Well Removeable Tube Strips can be used as a stand-alone product or inserted in one of two PCR plate frames for ease of handling
- 96 Well PCR Plate frames are available for use on Roche LightCycler® 480 and for universal use
- Pre-loaded frames are available
- Sealable using cap strips, adhesive seals or heat seals



8 Well Removeable Tube Strips can be used as a stand-alone product or with a frame for ease of handling.

## 8 Well PCR Tube Strips

Low profile, 0.1 ml polypropylene wells, working volume: <100 µl, total well capacity: 200 µl; can be used as a stand-alone product or inserted in any of the 96 Well PCR Plate frames available for ease of handling

- These low profile PCR tube strips are molded from virgin polypropylene under cleanroom conditions
- They are available in either clear polypropylene for standard PCR techniques, or in white polypropylene for use in fluorescent detection applications like qPCR, as they give the highest sensitivity and consistency as all the fluorescence signal is reflected back to the detector

### Key Features

- Free from DNase, RNase, human genomic DNA, and endotoxin/pyrogen

### Tubes

- Ultra-smooth, uniform, thin-walled polypropylene tubes for optimum PCR and real-time (RT-qPCR) results
- Low profile 0.1 ml (100 µl) working volume, with a 0.2 ml (200 µl) total well capacity when used with sealing options
- Raised well rims prevent cross contamination and facilitate effective sealing for reduced evaporation

### Specifications

Parameter	Value
Strip length	82.00 ± 0.10 mm
Strip width	8.20 mm
Strip height	15.60
Well depth	14.20 mm
Well diameter	5.50 ± 0.10 mm
Pitch (distance between A1 and A2)	9.00 mm



### Use

- Can be used as individual strips, or in a 96 Well PCR Plate frame for easier handling
- Compatible with standard multichannel pipettes

### Use

- 8 Well Removeable Tube Strips are available with clear wells
- 8 Well Removeable Tube Strips also available with white wells, giving the highest sensitivity and consistency for fluorescent detection during qPCR
- Combi packs available with strips of 8 flat optical caps
- 8 Well Removeable Tube Strips can be ordered separately or pre-loaded on 96 Well PCR Plate frames

## Ordering Information

<b>4ti-0753</b>	<b>8 Well PCR Tube Strips, white PP wells, low profile, 120 tube strips per case</b>
<b>4ti-0753/C</b>	<b>8 Well PCR Tube Strips, clear PP, low profile, 120 tube strips per case</b>
<b>Combi Pack</b>	
<b>4ti-0754/C</b>	<b>8 Well PCR Tube Strips, clear PP, low profile, plus cap strips, 4ti-0753 plus 4ti-0751 combi pack, 120 tube strips and cap strips per case</b>

For recommended plate options depending on manufacturer, block type, and instrument please refer to the Azenta Plate Instrument Compatibility Table Page 187.

# 96 Well Skirted PCR Plate Frame for Removable 8 Well Tube Strips

Rigid polycarbonate frame, for use with Removable 8 Well Tube Strips available for use on Roche LightCycler® 480 and for universal use

- These 96 Well Skirted PCR Plate frames are molded from rigid polycarbonate for use with our polypropylene Removable 8 Well Tube Strips
- The Removable 8 Well Tube Strips are inserted into the 96 Well Skirted PCR Plate frames to form a complete plate, part plate, or individual strip with an easy-to-handle frame
- As the Removable 8 Well Tube Strips are interchangeable with the 96 Well Skirted PCR Plate frames, the frames themselves are reusable; simply purchase more Removable 8 Well Tube Strips to use
- 96 Well Skirted PCR Plate frames can be purchased separately, or pre-loaded with Removable 8 Well Tube Strips

## Key Features

- Free from DNase, RNase, human genomic DNA, and endotoxin/pyrogen

## Frames

- Rigid polycarbonate frames, which reduce thermal expansion and sample evaporation during PCR, leading to improved consistency in PCR results
- Alphanumeric grid reference to aid well and sample identification

## Use

- Compatible with standard multichannel pipettes

## Specifications

Parameter	Value	
	96 Well Skirted PCR Plate Frame	96 Well Semi-Skirted PCR Plate Frame, Roche Style
Plate length	127.76 ± 0.25 mm	127.70 ± 0.25 mm
Plate width	85.48 ± 0.25 mm	85.48 ± 0.25 mm
Plate height	16.10 ± 0.25 mm	15.60 ± 0.25 mm
Well depth	15.10 ± 0.10 mm	15.10 ± 0.10 mm
Well diameter	5.50 ± 0.10 mm	5.50 ± 0.10 mm
Distance to center of A1 from top edge	11.24 ± 0.25 mm	11.24 ± 0.25 mm
Distance to center of A1 from left edge	14.38 ± 0.25 mm	14.38 ± 0.25 mm
Pitch (distance between A1 and A2)	9.00 mm	9.00 mm

For recommended plate options depending on manufacturer, block type, and instrument please refer to the Azenta Plate Instrument Compatibility Table Page 187.

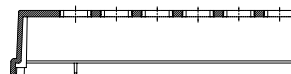

4ti-0757-F

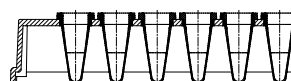

4ti-0753/757 &  
4ti-0753/C/757

## Options

- Available as a 96 Well Skirted Frame for universal use
- Also available as a 96 Well Semi-Skirted Frame, Roche Style for use with the Roche LightCycler® 480
- Frames can be purchased on their own or pre-loaded with Removable 8 Well Tube Strips
- Removable 8 Well Tube Strips are available with clear wells
- Removable 8 Well Tube Strips also available with white wells, giving the highest sensitivity and consistency for fluorescent detection during qPCR
- Available barcoded upon request

## Ordering Information

### 96 Well Skirted PCR Plate Frame

4ti-0757-F	96 Well Skirted PCR Plate for Removable 8 Well Strips, white PC frame, 50 plates per case
4ti-0753/757	96 Well Skirted PCR Plate with Removable 8 Well Strips, white PP wells, white PC frame, low profile, 50 plates per case
4ti-0753/C/757	96 Well Skirted PCR Plate with Removable 8 Well Strips, clear PP wells, white PC frame, low profile, 50 plates per case

### 96 Well Semi-Skirted PCR Plate Frame, Roche Style

4ti-0950W-F	96 Well Semi-Skirted PCR Plate for Removable 8 Well Strips, Roche style, white PC frame, low profile, cut corner H12, 10 frames per case
4ti-0753/950W	96 Well Skirted PCR Plate with Removable 8 Well Strips, Roche style, white PP wells, white PC frame, low profile, 50 plates per case



**AZENTA**  
LIFE SCIENCES

# Standard PCR Plates, Strips & Tubes





# Standard PCR Plates, Strips & Tubes

Azenta offers a wide range of PCR consumables for low to medium throughput applications. Our standard one-piece PCR consumables are manufactured from virgin polypropylene in our Class 7 ISO certified clean-room production facility, and comply to the same stringent QC requirements as our FrameStar range.

The ultra-thin walled tubes of our standard PCR plates maximize heat transfer and the raised rims facilitate sealing. Our range of plates includes fully skirted, semi-skirted, and non-skirted plates, available in clear or white (for qPCR), with additional colors for non-skirted plates available.

All our PCR consumables are certified free from RNase, DNase, and human genomic DNA.

These plates fit most thermal cyclers; for a complete list please see the compatibility table.

- **Clean-room Injection Molding - Class 7 ISO Certification**

No contamination and 10 fold lower amount of air particles compared to most PCR plate manufacturers

- **Virgin, Medical Grade Polymers**

No leakage of substances which may have a detrimental effect on product purity

- **Certified RNase-, DNase-, DNA, and Pyrogen-free**

Inhibitor free consumables

- **Ultra-thin and consistent wall thickness**

Fast and precise thermal transfer

*Azenta's standard PCR plates, strips and tubes are manufactured from virgin polypropylene under ISO certified cleanroom conditions.*



# 384 Well Skirted PCR Plate

**Polypropylene, cut corner A24, working volume: <30 µl, total well capacity: 55 µl; designed for use on standard 384 well thermal cyclers**

- All of our PCR plates are molded from virgin polypropylene under ISO certified cleanroom conditions in our UK-based production facility, and as such comply with the same stringent requirements as our FrameStar range

## Key Features

- Subject to a strict QC procedure which includes a visual check and leak testing of every tube
- Free from DNase, RNase, human genomic DNA, and endotoxin/pyrogen

## Wells

- Ultra-smooth, uniform, thin-walled polypropylene tubes for optimum PCR and real-time quantitative PCR (RT-qPCR) results
- <30 µl working volume, 55 µl total well capacity when used with sealing options
- Maximum thermal conductivity for efficient heat transfer and precise thermal cycling
- Raised well rims prevent cross contamination and facilitate effective sealing for reduced evaporation

## Frame

- Alphanumeric grid reference to aid well and sample identification

## Use

- Recommended for low volume PCR
- Compatible with blocks designed for 384 well PCR plates
- Compatible with standard multichannel pipettes

## Options

- Super clear well option available to maximize sample visibility
- Also available as a frosted plate for increased qPCR signal intensities and improved detection sensitivity
- Available barcoded upon request
- Available as a FrameStar 2-component PCR plate with the same dimensions, but with the added benefits of a polycarbonate frame that eliminates plate distortion and warping during the PCR process, leading to less evaporation and sample loss

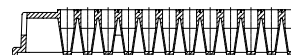

## Specifications

Parameter	Value
Plate length	127.76 ± 0.25 mm
Plate width	85.48 ± 0.25 mm
Plate height	10.30 ± 0.05 mm
Well depth	9.20 ± 0.10 mm
Well diameter	3.00 ± 0.10 mm
Distance to center of A1 from top edge	8.99 ± 0.25 mm
Distance to center of A1 from left edge	12.13 ± 0.25 mm
Pitch (distance between A1 and A2)	4.50 mm

## Ordering Information

<b>4ti-1384</b>	<b>384 Well Skirted PCR Plate, clear PP, cut corner A24, 50 plates per case</b>
<b>4ti-1387</b>	<b>384 Well Skirted PCR Plate, frosted PP, cut corner A24, 50 plates per case</b>
<b>4ti-1385</b>	<b>384 Well Skirted PCR Plate, white PP, cut corner A24, 50 plates per case</b>

*For recommended plate options depending on manufacturer, block type, and instrument please refer to the Azenta Plate Instrument Compatibility Table Page 187.*

# 384 Well Skirted PCR Plate, Roche Style

White polypropylene, cut corners A24 and P24; working volume: <30 µl, total well capacity: 55 µl; designed for use on the Roche LightCycler® 480 with 384 well block

- The dimensions of these plates are designed for optimum compatibility with the Roche LightCycler® 480, and are in a 384 well format for reaction volumes of up to 30 µl
- All of our PCR plates are molded from virgin polypropylene under ISO certified cleanroom conditions, and as such comply with the same stringent requirements as our FrameStar range



## Key Features

- Subject to a strict QC procedure which includes a visual check and leak testing of every tube
- Free from DNase, RNase, human genomic DNA, and endotoxin/pyrogen

## Wells

- Ultra-smooth, uniform, thin-walled polypropylene wells for optimum PCR and real-time (RT-qPCR) results
- <30 µl working volume, 55 µl total well capacity when used with sealing options
- Raised well rims prevent cross contamination and facilitate effective sealing for reduced evaporation
- Maximum thermal conductivity for efficient heat transfer and precise thermal cycling

## Frame

- Alphanumeric grid reference to aid well and sample identification

## Use

- Recommended for low volume PCR
- Compatible with Roche LightCycler® 480 with 384 well block
- Compatible with standard multichannel pipettes

## Options

- Available as a plate made from white polypropylene for optimum signal-to-noise ratio when using fluorescent based assays
- Available barcoded upon request
- Also available as a FrameStar 2-component PCR plate with the same dimensions, but with the added benefits of a polycarbonate frame that eliminates plate distortion and warping during the PCR process, leading to less evaporation and sample loss

## Specifications

Parameter	Value
Plate length	127.76 ± 0.25 mm
Plate width	85.48 ± 0.25 mm
Plate height	10.30 ± 0.05 mm
Well depth	9.20 ± 0.10 mm
Well diameter	3.00 ± 0.10 mm
Distance to center of A1 from top edge	8.99 ± 0.25 mm
Distance to center of A1 from left edge	12.13 ± 0.25 mm
Pitch (distance between A1 and A2)	4.50 mm

## Ordering Information

<b>4ti-1381</b>	<b>384 Well Skirted PCR Plate, Roche style, white PP, cut corner A24/P24, 50 plates per case</b>
-----------------	--

*For recommended plate options depending on manufacturer, block type, and instrument please refer to the Azenta Plate Instrument Compatibility Table Page 187.*



# 96 Well Skirted PCR Plate

**Low profile, 0.1 ml wells, polypropylene, cut corner H1, working volume: <100 µl, total well capacity: 200 µl; universal 96 well skirted plate, designed for use on standard thermal cyclers**

- All of our PCR plates are molded from virgin polypropylene under ISO certified cleanroom conditions in our UK-based production facility, and as such comply with the same stringent requirements as our FrameStar range.

## Key Features

- Subject to a strict QC procedure which includes a visual check and leak testing of every tube
- Free from DNase, RNase, human genomic DNA, and endotoxin/pyrogen

## Wells

- Ultra-smooth, uniform, thin-walled polypropylene tubes for optimum PCR and real-time (RT-qPCR) results
- Low profile 0.1 ml (100 µl) working volume, with a 0.2 ml (200 µl) total well capacity when used with sealing options
- Maximum thermal conductivity for efficient heat transfer and precise thermal cycling
- Raised well rims prevent cross contamination and facilitate effective sealing for reduced evaporation

## Frame

- Alphanumeric grid reference to aid well and sample identification

## Use

- Compatible with blocks designed for skirted PCR plates
- Compatible with standard multichannel pipettes

## Options

- Super clear wells maximize sample visibility
- Also available as a white plate, ideal for qPCR, giving optimal signal-to-noise ratio for fluorescence-based assays
- Available barcoded upon request
- Available as a FrameStar 2-component PCR plate with the same dimensions, but with the added benefits of a polycarbonate frame that eliminates plate distortion and warping during the PCR process, leading to less evaporation and sample loss

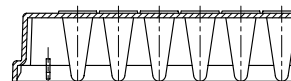
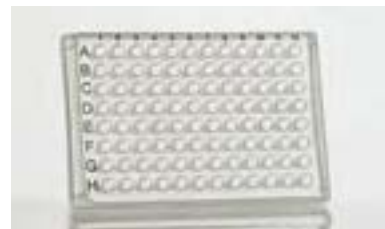

## Specifications

Parameter	Value
Plate length	127.76 ± 0.25 mm
Plate width	85.48 ± 0.25 mm
Plate height	15.50 ± 0.05 mm
Well depth	15.00 ± 0.10 mm
Well diameter	5.50 ± 0.10 mm
Distance to center of A1 from top edge	11.24 ± 0.25 mm
Distance to center of A1 from left edge	14.38 ± 0.25 mm
Pitch (distance between A1 and A2)	9.00 mm

## Ordering Information

<b>4ti-0740</b>	<b>96 Well Skirted PCR Plate, clear PP, low profile, cut corner H1, 50 plates per case</b>
<b>4ti-0741</b>	<b>96 Well Skirted PCR Plate, white PP, low profile, cut corner H1, 50 plates per case</b>

*For recommended plate options depending on manufacturer, block type, and instrument please refer to the Azenta Plate Instrument Compatibility Table Page 187.*

# 96 Well Semi-Skirted PCR Plate

High profile, 0.2 ml wells, polypropylene, cut corner A12, working volume: <200 µl, total well capacity: 300 µl; universal semi-skirted plate, designed for use on standard thermal cyclers

- All of our PCR plates are molded from virgin polypropylene under ISO certified cleanroom conditions in our UK-based production facility, and as such comply with the same stringent requirements as our FrameStar range.

## Key Features

- Subject to a strict QC procedure which includes a visual check and leak testing of every tube
- Free from DNase, RNase, human genomic DNA, and endotoxin/pyrogen

## Wells

- Ultra-smooth, uniform, thin-walled polypropylene tubes for optimum PCR and real-time (RT-qPCR) results
- Standard 0.2 ml (200 µl) working volume, with a 0.3 ml (300 µl) total well capacity when used with sealing options
- Maximum thermal conductivity for efficient heat transfer and precise thermal cycling
- Raised well rims prevent cross contamination and facilitate effective sealing for reduced evaporation

## Frame

- Alphanumeric grid reference to aid well and sample identification

## Use

- Compatible with universal standard block thermal cyclers and sequencers
- Compatible with standard multichannel pipettes

## Options

- Super clear wells maximize sample visibility
- Also available as a white plate, ideal for qPCR, giving optimal signal-to-noise ratio for fluorescence-based assays
- Available barcoded upon request
- Available as a FrameStar 2-component PCR plate with the same dimensions, but with the added benefits of a polycarbonate frame that eliminates plate distortion and warping during the PCR process, leading to less evaporation and sample loss

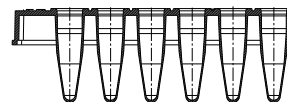
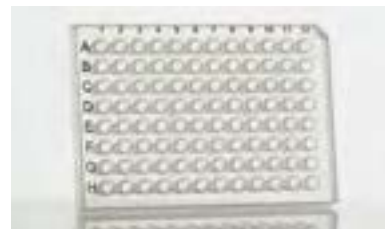

## Specifications

Parameter	Value
Plate length	124.42 ± 0.25 mm
Plate width	84.02 ± 0.25 mm
Plate height	20.70 ± 0.25 mm
Well depth	20.20 ± 0.10 mm
Well diameter	5.46 ± 0.10 mm
Distance to center of A1 from top edge	10.51 ± 0.10 mm
Distance to center of A1 from left edge	12.71 ± 0.10 mm
Pitch (distance between A1 and A2)	9.00 mm

## Ordering Information

<b>4ti-0760</b>	<b>96 Well Semi-Skirted PCR Plate, clear PP, high profile, cut corner A12, 50 plates per case</b>
<b>4ti-0761</b>	<b>96 Well Semi-Skirted PCR Plate, white PP, high profile, cut corner A12, 50 plates per case</b>

*For recommended plate options depending on manufacturer, block type, and instrument please refer to the Azenta Plate Instrument Compatibility Table Page 187.*

# 96 Well Semi-Skirted PCR Plate, Roche Style

**Low profile, 0.1 ml wells, polypropylene, cut corner H12, working volume: <100 µl, total well capacity: 200 µl; designed for use on Roche LightCycler 480®**

- This Roche Style plate is designed to achieve optimized assay conditions on the Roche LightCycler® 480
- This particular style of plate is in a low profile 96-well format, perfect for reaction volumes of 10-100 µl
- The wells are shorter than “standard” profile wells, which decrease the “dead space” between the heated lid of the thermal cycler and the sample in the well
- This eliminates condensation forming on the side wall of the tubes, preventing reduction in PCR volume and increasing the efficiency of the reaction
- This is especially recommended for reaction volumes below 20 µl

## Key Features

- Subject to a strict QC procedure which includes a visual check and leak testing of every tube
- Free from DNase, RNase, human genomic DNA, and endotoxin/pyrogen

## Wells

- Ultra-smooth, uniform, thin-walled polypropylene tubes for optimum PCR and real-time (RT-qPCR) results
- Low profile 0.1 ml (100 µl) working volume, with a 0.2 ml (200 µl) total well capacity when used with sealing options
- Maximum thermal conductivity for efficient heat transfer and precise thermal cycling

## Frame

- Alphanumeric grid reference to aid well and sample identification

## Use

- Optimized for use with the Roche LightCycler® 480
- Recommended for low volume PCR
- Compatible with standard multichannel pipettes

## Options

- Available with white wells give optimum signal-to-noise ratio when using fluorescent-based assays
- Combi packs available with qPCR Seal (0560)
- Available barcoded upon request
- Available as a FrameStar 2-component PCR plate with the same dimensions, but with the added benefits of a polycarbonate frame that eliminates plate distortion and warping during the PCR process, leading to less evaporation and sample loss



## Specifications

Parameter	Value
Plate length	127.70 ± 0.25 mm
Plate width	85.48 ± 0.25 mm
Plate height	15.60 ± 0.10 mm
Well depth	15.10 ± 0.10 mm
Well diameter	5.50 ± 0.10 mm
Distance to center of A1 from top edge	11.24 ± 0.25 mm
Distance to center of A1 from left edge	14.38 ± 0.25 mm
Pitch (distance between A1 and A2)	9.00 mm

## Ordering Information

<b>4ti-0955</b>	<b>96 Well Semi-Skirted PCR Plate, Roche style, white PP, low profile, cut corner H12, 50 plates per case</b>
<b>Combi packs</b>	
<b>4ti-0955/0560</b>	<b>96 Well Semi-Skirted PCR Plate, Roche style, plus qPCR Seal, 4TI-0955 plus 4TI-0560, combi pack, 50 plates and seals per case</b>

*For recommended plate options depending on manufacturer, block type, and instrument please refer to the Azenta Plate Instrument Compatibility Table Page 187.*

# 96 Well Semi-Skirted PCR Plate with Upstand ABI® Style

High profile, 0.2 ml wells, polypropylene, cut corner A12, working volume: <200 µl, total well capacity: 300 µl; designed for use on ABI® thermal cyclers

- We recommend this semi-skirted plate for use with ABI® thermal cyclers and sequencers
- It can be used directly with ABI® instruments with no adapters and no re-calibration of the instruments necessary
- The only case where this is not true is with the ABI Fast Block thermal cyclers, in which case using our FrameStar FastPlate is recommended instead
- All of our PCR plates are molded from virgin polypropylene under ISO certified cleanroom conditions in our UK-based production facility, and as such comply with the same stringent requirements as our FrameStar range

## Key Features

- Subject to a strict QC procedure which includes a visual check and leak testing of every tube
- Free from DNase, RNase, human genomic DNA, and endotoxin/pyrogen

## Wells

- Ultra-smooth, uniform, thin-walled polypropylene tubes for optimum PCR and real-time qPCR results
- Standard 0.2 ml (200 µl) working volume, with a 0.3 ml (300 µl) total well capacity when used with sealing options
- Maximum thermal conductivity for efficient heat transfer and precise thermal cycling
- Raised well rims prevent cross contamination and facilitate effective sealing for reduced evaporation

## Frame

- Alphanumeric grid reference to aid well and sample identification

## Use

- Designed for and compatible with ABI® thermal cyclers and Real Time PCR instruments
- Compatible with standard multichannel pipettes

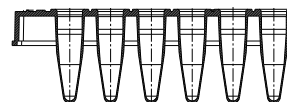
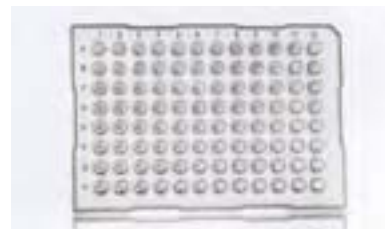

## Options

- Clear version has super clear wells for maximum sample visibility
- Also available with frosted wells for increased qPCR signal intensities and improved detection sensitivity
- Available barcoded upon request
- Available as a FrameStar 2-component PCR plate with the same dimensions, but with the added benefits of a polycarbonate frame that eliminates plate distortion and warping during the PCR process, leading to less evaporation and sample loss

## Specifications

Parameter	Value
Plate length	126.00 ± 0.25 mm
Plate width	86.00 ± 0.25 mm
Plate height	22.10 ± 0.10 mm
Well depth	20.20 ± 0.10 mm
Well diameter	5.46 ± 0.10 mm
Distance to center of A1 from top edge	11.50 ± 0.10 mm
Distance to center of A1 from left edge	13.50 ± 0.10 mm
Pitch (distance between A1 and A2)	9.00 mm

## Ordering Information

4ti-0735	96 Well Semi-Skirted PCR Plate, ABI style, clear PP, with upstand, high profile, cut corner H12, 50 plates per case
4ti-0736	96 Well Semi-Skirted PCR Plate, ABI style, frosted PP, with upstand, high profile, cut corner H12, 50 plates per case

For recommended plate options depending on manufacturer, block type, and instrument please refer to the Azenta Plate Instrument Compatibility Table Page 187.

# 96 Well Non-Skirted PCR Plate

High profile, 0.2 ml wells, polypropylene, cut corner H12, working volume: <200 µl, total well capacity: 300 µl; universal non-skirted plate, designed for use on standard thermal cyclers

- All of our PCR plates are molded from virgin polypropylene under ISO certified cleanroom conditions in our UK-based production facility, and as such comply with the same stringent requirements as our FrameStar range

## Key Features

- Subject to a strict QC procedure which includes a visual check and leak testing of every tube
- Free from DNase, RNase, human genomic DNA, and endotoxin/pyrogen

## Wells

- Ultra-smooth, uniform, thin-walled polypropylene tubes for optimum PCR and real-time (RT-qPCR) results
- 0.2 ml (200 µl) working volume, with a 0.3 ml (300 µl) total well capacity when used with sealing options
- Maximum thermal conductivity for efficient heat transfer and precise thermal cycling
- Raised well rims prevent cross contamination and facilitate effective sealing for reduced evaporation

## Frame

- Alphanumeric grid reference to aid well and sample identification

## Use

- Compatible with universal standard block thermal cyclers and sequencers
- Compatible with standard multichannel pipettes

## Specifications

Parameter	Value
Plate length	120.00 ± 0.25 mm
Plate width	80.00 ± 0.25 mm
Plate height	20.20 ± 0.10 mm
Well depth	20.20 ± 0.10 mm
Well diameter	5.46 ± 0.10 mm
Distance to center of A1 from top edge	8.75 ± 0.25 mm
Distance to center of A1 from left edge	10.75 ± 0.25 mm
Pitch (distance between A1 and A2)	9.00 mm

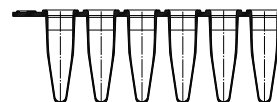

## Options

- Available with the following color options: clear, blue, red, green, yellow, purple, and white
- Super clear well version maximizes sample visibility
- White plate ideal for qPCR, giving optimal signal-to-noise ratio for fluorescence-based assays

## Ordering Information

<b>4ti-0750</b>	96 Well Non-Skirted PCR Plate, clear PP, high profile, cut corner H12, 50 plates per case
<b>4ti-0750-25</b>	96 Well Non-Skirted PCR Plate, clear PP, high profile, cut corner H12, 25 plates per case
<b>4ti-0750/P</b>	96 Well Non-Skirted PCR Plate, purple PP, high profile, cut corner H12, 50 plates per case
<b>4ti-0750/B</b>	96 Well Non-Skirted PCR Plate, blue PP, high profile, cut corner H12, 50 plates per case
<b>4ti-0750/G</b>	96 Well Non-Skirted PCR Plate, green PP, high profile, cut corner H12, 50 plates per case
<b>4ti-0750/R</b>	96 Well Non-Skirted PCR Plate, red PP, high profile, cut corner H12, 50 plates per case
<b>4ti-0750/W</b>	96 Well Non-Skirted PCR Plate, white PP, high profile, cut corner H12, 50 plates per case
<b>4ti-0750/Y</b>	96 Well Non-Skirted PCR Plate, yellow PP, high profile, cut corner H12, 50 plates per case

For recommended plate options depending on manufacturer, block type, and instrument please refer to the Azenta Plate Instrument Compatibility Table Page 187.



# Non-Skirted PCR Plate Segments

High profile, 0.2 ml wells, polypropylene, cut corner H12, working volume: <200 µl, total well capacity: 300 µl; 96 Well Non-Skirted PCR Plate divided into 8 well, 16 well, 24 well, 32 well or 48 well segments

- These plates are produced by dividing our 96 Well Non-Skirted PCR Plate into smaller segments, a versatile solution for when a whole PCR plate may not be needed
- All of our PCR plates are molded from virgin polypropylene under ISO certified cleanroom conditions in our UK-based production facility, and as such comply with the same stringent requirements as our FrameStar range

## Key Features

- Subject to a strict QC procedure which includes a visual check and leak testing of every tube
- Free from DNase, RNase, human genomic DNA, and endotoxin/pyrogen

## Wells

- Ultra-smooth, uniform, thin-walled polypropylene tubes for optimum PCR and real-time (RT-qPCR) results
- Standard 0.2 ml (200 µl) working volume, with a 0.3 ml (300 µl) total well capacity when used with sealing options
- Maximum thermal conductivity for efficient heat transfer and precise thermal cycling
- Raised well rims prevent cross contamination and facilitate effective sealing for reduced evaporation

## Frame

- Alphanumeric grid reference to aid well and sample identification

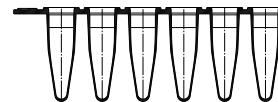

## Use

- Compatible with universal standard block thermal cyclers and sequencers
- Compatible with standard multichannel pipettes

## Options

- Available with the following color options: clear, blue, red, green, yellow, and purple
- Super clear well version maximizes sample visibility

## Specifications

Parameter	Value
Plate length	120.00 ± 0.25 mm
Plate width	80.00 ± 0.25 mm
Plate height	20.20 ± 0.10 mm
Well depth	20.20 ± 0.10 mm
Well diameter	5.46 ± 0.10 mm
Distance to center of A1 from top edge	8.75 ± 0.25 mm
Distance to center of A1 from left edge	10.75 ± 0.25 mm
Pitch (distance between A1 and A2)	9.00 mm



## Non-Skirted PCR Plate Segments

### Ordering Information

#### Clear 8 Well Non-Skirted PCR Plate Segment

4ti-0750/8	8 Well Non-Skirted PCR Plate Segment, clear PP, high profile, 600 segments per case
4ti-0750/16	16 Well Non-Skirted PCR Plate Segment, clear PP, high profile, 300 segments per case
4ti-0750/24	24 Well Non-Skirted PCR Plate Segment, clear PP, high profile, 200 segments per case
4ti-0750/32	32 Well Non-Skirted PCR Plate Segment, clear PP, high profile, 150 segments per case
4ti-0750/48	48 Well Non-Skirted PCR Plate Segment, clear PP, high profile, 100 segments per case

#### Blue 8 Well Non-Skirted PCR Plate Segment

4ti-0750/8/B	8 Well Non-Skirted PCR Plate Segment, blue PP, high profile, 600 segments per case
4ti-0750/16/B	16 Well Non-Skirted PCR Plate Segment, blue PP, high profile, 300 segments per case
4ti-0750/24/B	24 Well Non-Skirted PCR Plate Segment, blue PP, high profile, 200 segments per case
4ti-0750/32/B	32 Well Non-Skirted PCR Plate Segment, blue PP, high profile, 150 segments per case
4ti-0750/48/B	48 Well Non-Skirted PCR Plate Segment, blue PP, high profile, 100 segments per case

#### Purple 8 Well Non-Skirted PCR Plate Segment

4ti-0750/8/P	8 Well Non-Skirted PCR Plate Segment, purple PP, high profile, 600 segments per case
4ti-0750/16/P	16 Well Non-Skirted PCR Plate Segment, purple PP, high profile, 300 segments per case
4ti-0750/24/P	24 Well Non-Skirted PCR Plate Segment, purple PP, high profile, 200 segments per case
4ti-0750/32/P	32 Well Non-Skirted PCR Plate Segment, purple PP, high profile, 150 segments per case
4ti-0750/48/P	48 Well Non-Skirted PCR Plate Segment, purple PP, high profile, 100 segments per case

#### Yellow 8 Well Non-Skirted PCR Plate Segment

4ti-0750/8/Y	8 Well Non-Skirted PCR Plate Segment, yellow PP, high profile, 600 segments per case
4ti-0750/16/Y	16 Well Non-Skirted PCR Plate Segment, yellow PP, high profile, 300 segments per case
4ti-0750/24/Y	24 Well Non-Skirted PCR Plate Segment, yellow PP, high profile, 200 segments per case
4ti-0750/32/Y	32 Well Non-Skirted PCR Plate Segment, yellow PP, high profile, 150 segments per case
4ti-0750/48/Y	48 Well Non-Skirted PCR Plate Segment, yellow PP, high profile, 100 segments per case

#### Red 8 Well Non-Skirted PCR Plate Segment

4ti-0750/8/R	8 Well Non-Skirted PCR Plate Segment, red PP, high profile, 600 segments per case
4ti-0750/16/R	16 Well Non-Skirted PCR Plate Segment, red PP, high profile, 300 segments per case
4ti-0750/24/R	24 Well Non-Skirted PCR Plate Segment, red PP, high profile, 200 segments per case
4ti-0750/32/R	32 Well Non-Skirted PCR Plate Segment, red PP, high profile, 150 segments per case
4ti-0750/48/R	48 Well Non-Skirted PCR Plate Segment, red PP, high profile, 100 segments per case

#### Green 8 Well Non-Skirted PCR Plate Segment

4ti-0750/8/G	8 Well Non-Skirted PCR Plate Segment, green PP, high profile, 600 segments per case
4ti-0750/16/G	16 Well Non-Skirted PCR Plate Segment, green PP, high profile, 300 segments per case
4ti-0750/24/G	24 Well Non-Skirted PCR Plate Segment, green PP, high profile, 200 segments per case
4ti-0750/32/G	32 Well Non-Skirted PCR Plate Segment, green PP, high profile, 150 segments per case
4ti-0750/48/G	48 Well Non-Skirted PCR Plate Segment, green PP, high profile, 100 segments per case

*For recommended plate options depending on manufacturer, block type, and instrument please refer to the Azenta Plate Instrument Compatibility Table Page 187.*

# 8 Well PCR Tube Strips

**High profile, 0.2 ml wells, clear polypropylene, working volume: <200 µl, total well capacity: 300 µl; suitable for all standard 0.2 ml block thermal cyclers**

- These PCR tubes are molded from virgin polypropylene in our UK-based Class 7 ISO certified cleanroom production facility, and comply to the same stringent requirements as our FrameStar range
- Recommended for low to medium throughput applications



## Key Features

- Free from DNase, RNase, human genomic DNA, and endotoxin/pyrogen

## Tubes

- Ultra-smooth, uniform, thin-walled polypropylene tubes for optimum PCR and real-time (RT-qPCR) results
- Standard 0.2 ml (200 µl) working volume, with a 0.3 ml (300 µl) total well capacity when used with sealing options
- Individually numbered tubes

## Use

- Suitable for all standard 0.2 ml block thermal cyclers
- Can be cut into sections

## Options

- Available with strips of domed (4ti-0780) or flat optical (4ti-0784) sealing caps\*

## Ordering Information

<b>4ti-0781</b>	<b>8 Well PCR Tube Strips, clear PP, high profile, 125 strips per case</b>
<b>Code Combi Pack</b>	
<b>4ti-0780</b>	<b>8 Well PCR Tube Strips, plus Strips of Domed Caps, 4ti-0781 plus 4ti-0782, combi pack, 125 tube strips and cap strips per case</b>
<b>4ti-0784</b>	<b>8 Well PCR Tube Strips, plus Strips of Flat Caps, 4ti-0781 plus 4ti-0783, combi pack, 125 tube strips and cap strips per case</b>

*For recommended plate options depending on manufacturer, block type, and instrument please refer to the Azenta Plate Instrument Compatibility Table Page 187.*

\* See website for the latest Important Product Information



**AZENTA**  
LIFE SCIENCES

# 8 Well PCR Tube Strips, With Attached Caps

Low profile 0.1 ml (working volume: <100 µl, total well capacity: 200 µl), clear polypropylene, with attached flat optically clear caps; and standard 0.2 ml (working volume: <200 µl, total well capacity: 300 µl), clear polypropylene, with attached domed or flat optically clear caps

- These PCR tubes with attached caps are molded from virgin polypropylene, comply to the same stringent requirements as our FrameStar range and are free from RNase, DNase, and human genomic DNA
- Recommended for low to medium throughput applications

## Key Features

- Free from DNase, RNase, human genomic DNA, and endotoxin/pyrogen

## Tubes

- The tubes on each strip are joined together either by three links (flat cap variety - 4ti-0792 and 4ti-0793) or by one strong link (domed cap variety - 4ti-0794) to make the strip more rigid and help reduce any chance of spillage
- Each cap is separately joined to a tube, making it impossible to either cross contaminate another tube with the wrong cap, or to lose a cap altogether

## Use

- The tube strips can be easily separated by cutting the links, to make smaller sections or individual tubes
- The flat optically clear caps enable light signals, such as fluorescence, to pass through without affecting the signal, and are suitable for imaging techniques including RT-qPCR

## Options

- The strips are available with either tethered flat optically clear caps or domed caps

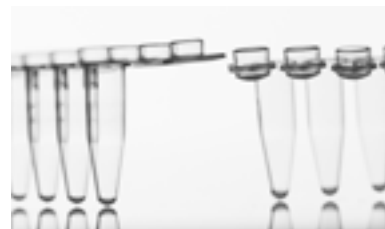

## Ordering Information

<b>4ti-0792</b>	<b>8 Well PCR Tube Strips, with Attached Flat Caps, 0.2ml wells, clear PP, high profile, 120 tube strips per case</b>
<b>4ti-0793</b>	<b>8 Well PCR Tube Strips, with Attached Flat Caps, 0.1ml wells, clear PP, low profile, 120 tube strips per case</b>
<b>4ti-0794</b>	<b>8 Well PCR Tube Strips, with Attached Domed Caps, 0.2ml wells, clear PP, high profile, 120 tube strips per case</b>

*For recommended plate options depending on manufacturer, block type, and instrument please refer to the Azenta Plate Instrument Compatibility Table Page 187.*



# 4 Well PCR Tube Strips, Rotor-Gene® Style, With Caps

0.1 ml wells, clear polypropylene, with strips of 4 caps, working volume: <100 µl, total well capacity: 200 µl; designed for Qiagen/Corbett Rotor-Gene® instruments

- Azena offers a range of PCR consumables for low to medium throughput applications
- These PCR tubes and caps are molded from virgin polypropylene to prevent any PCR background signal
- They are especially suited for use with Qiagen/Corbett Rotor-Gene® instruments

## Key Features

- Free from DNase, RNase, human genomic DNA, and endotoxin/pyrogen

## Tubes

- Optically clear tubes ideally suited for qPCR
- Low profile 0.1 ml (100 µl) working volume, 0.2 ml (200 µl) total well capacity
- Ultra-smooth, uniform, thin-walled polypropylene tubes for optimum PCR and real-time (RT-qPCR) results

## Caps

- Frosted cap extensions allow for easy handling and labeling

## Use

- Designed for Qiagen/Corbett Rotor-Gene® instruments
- Tube and cap strips can be separated for individual use
- Pack of 250 strips of tubes and caps sufficient for 1,000 reactions



## Ordering Information

4ti-0796

4 Well PCR Tube Strips, Rotor-Gene style, plus strips of caps, clear PP, 250 tube strips and cap strips per case

*For recommended plate options depending on manufacturer, block type, and instrument please refer to the Azena Plate Instrument Compatibility Table Page 187.*



**AZENTA**  
LIFE SCIENCES

# Individual PCR Tubes, With Attached Caps

High profile, 0.2 ml wells, polypropylene, working volume <200 µl, total well capacity: 300 µl; with either flat or domed attached caps; also available with unique 2D coded flat caps

- These PCR tubes are molded from virgin polypropylene in our UK-based Class 7 ISO certified cleanroom production facility, and comply to the same stringent requirements as our FrameStar range
- Recommended for low to medium throughput applications
- Our individual tubes with flat caps are also available with a unique 2D code applied to the top of each tube
- This allows for clear labeling of tubes, despite the limited space available
- Printed 2D codes allow for easy sample tracking and are more reliable than the use of adhesive stickers
- Our compact hand held barcode scanner, 4ti-4060, delivers the speed typical of laser scanners on any barcode, including both 1D and 2D codes

## Key Features

- Leak tested
- Free from DNase, RNase, human genomic DNA, and endotoxin/pyrogen

## Tubes

- 0.2 ml (200 µl) working volume, 0.3 ml (300 µl) total well capacity
- Snap-shut cap design

## Uses

- Suitable for all standard 0.2 ml block thermal cyclers

## Options

- Flat and domed cap designs
- Our individual tubes with flat caps (4ti-0790) are also available with unique 2D code applied to the top of each tube (use product code 4ti-0790/2D when ordering); the barcode is suitable for low temperature storage and high temperature thermal cycling
- Our hand held barcode scanner, 4ti-4060 together with the user-friendly software allows for reliable and convenient sample management



## Ordering Information

<b>4ti-0790</b>	<b>Individual PCR Tubes with Attached Flat Caps, 0.2ml, clear PP wells, 1000 tubes per case</b>
<b>4ti-0790/2D</b>	<b>Individual PCR Tubes with Attached Flat Caps, 0.2ml, clear PP, 2D coded, high profile, 960 tubes per case</b>
<b>4ti-0795</b>	<b>Individual PCR Tubes with Attached Domed Caps, 0.2ml, clear PP, high profile, 1000 tubes per case</b>

*For recommended plate options depending on manufacturer, block type, and instrument please refer to the Azenta Plate Instrument Compatibility Table Page 187.*



**AZENTA**  
LIFE SCIENCES

# Non-Skirted PCR Plates Breakable Horizontally or Vertically





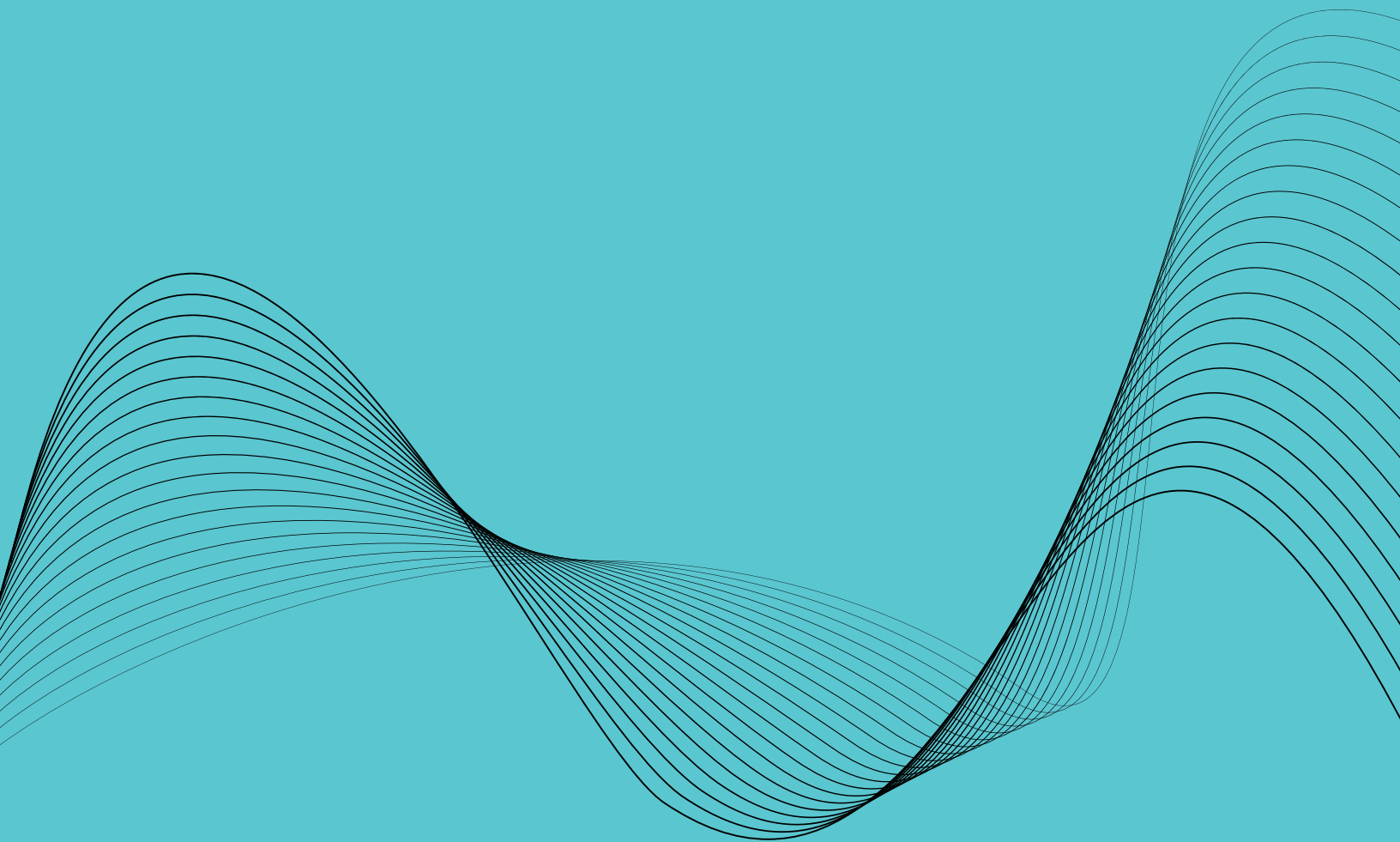

**AZENTA**  
LIFE SCIENCES

# Non-Skirted PCR Plates Breakable Horizontally or Vertically

Non-Skirted PCR Plates Breakable Horizontally or Vertically allow for the most flexible, efficient and cost-effective use of a PCR plate. Avoid the costly use of half-empty plates or the fiddly separation of plates with scissors. Cutting plates can damage wells and sealing rings, risking evaporation and sample contamination.

Based on our standard non-skirted PCR plate (4ti-0750), Non-Skirted PCR Plates Breakable Horizontally or Vertically can be quickly and easily divided along the perforations between the rows. The correct number of wells can be separated off for each experiment, saving time and costs.

The Non-Skirted PCR Plates Breakable Horizontally or Vertically are available perforated either in the vertical direction, tearing into 8 well strips, or in the horizontal direction, tearing into 12 well strips. Both versions maintain all the benefits of our standard non-skirted PCR plate, but with increased flexibility.

- **Allows for the most flexible and efficient use of a PCR plate** — no need to run half-empty plates, so reducing costs
- **Plate is perforated to enable accurate tearing into either 8 well or 12 well strips** — no tricky cutting of plates with scissors risking perforating wells, damaging sealing rings and contamination
- **Black grid reference on all strips** — No sample identification errors
- **Non-skirted plates** — Universal cyclers and sequencer compatibility
- **8 well version is easily divided into 24 and 48 well plates** to fit a 24 or 48 well thermal cycler block
- **12 well version perfectly suited for gradient cyclers**
- **White version available for superior qPCR performance**



*96/12 Non-Skirted PCR Plates Breakable Horizontally or Vertically allow you to make full use of your gradient PCR instruments. The temperature gradient is typically created along the horizontal direction of the block, thus 12 well strips or sections are ideal.*



## How trustworthy are your scissors?

*Scissors are widely used by everyone in the lab and are typically highly contaminated with substances including bacteria and DNA. Cutting PCR plates with scissors should be avoided as it may lead to contamination of the wells.*



# 96 Well Non-Skirted PCR Plate Breakable Horizontally or Vertically

96 well non-skirted PCR plate, vertically or horizontally perforated, high profile, 0.2 ml wells, polypropylene, cut corner H12; working volume: <200 µl, total well capacity: 300 µl; tears easily into strips or part plates; universal cyclers and sequencer compatibility

- Non-Skirted PCR Plates Breakable Horizontally or Vertically allow for the most flexible, efficient and cost-effective use of a PCR plate
- Avoid the costly use of half-empty plates or the fiddly separation of plates with scissors
- Scissors are widely used by everyone in the lab for cutting diverse materials, so are typically highly contaminated with substances including bacteria and DNA
- Cutting plates with scissors should be avoided as it can perforate wells and damage sealing rings, risking evaporation and sample contamination
- Based on our 96 Well Non-Skirted PCR Plate, plates can be quickly and easily divided along the perforations between the rows
- The correct number of wells can be separated off for each experiment, saving time and costs
- Available perforated either vertically, tearing into 8-well strips (96/8), or horizontally, tearing into 12-well strips (96/12)
- The new 12-strip 96/12 plates allow you to make full use of your gradient PCR instruments
- The temperature gradient is typically created along the horizontal direction of the block, thus 12-well strips or sections are ideal
- All of our PCR plates are molded from virgin polypropylene under ISO-certified cleanroom conditions in our UK-based production facility, and as such comply with the same stringent requirements as our FrameStar range
- This plate is perforated under the same cleanroom conditions post-manufacture so it can be separated into part plates or individual strips of tubes
- The Breakable Horizontally or Vertically Plate maintains all benefits of the 96 Well Non-Skirted PCR Plate, but adds extra flexibility

## Key Features

- Free from DNase, RNase, human genomic DNA, and endotoxin/pyrogen

## Frame

- Non-skirted plates: universal cycler and sequencer compatibility
- Alphanumeric grid reference on all strips: no sample identification errors
- Plate is perforated to enable accurate tearing into 8-well or 12-well strips: no tricky cutting of plates with scissors, risking perforated wells, damaging sealing rings, and contamination

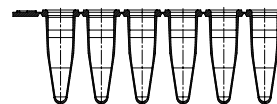

## Use

- Allows for the most flexible and efficient use of a PCR plate: no need to run half-empty plates, so reducing costs
- Snaps into strips for lower throughput: cost effective

## Options

- The 96/8 8-well version is easily divided into 24 and 48-well plates to fit a 24 or 48-well thermal cycler block
- The 96/12 12-well version perfectly suited for gradient cyclers
- White version available for superior qPCR performance
- Sealable with Azenta PCR cap strips, adhesive seals and heat seals

## Specifications

Parameter	Value
Plate length	120.00 ± 0.25 mm
Plate width	80.00 ± 0.25 mm
Plate height	20.20 ± 0.10 mm
Well depth	20.20 ± 0.10 mm
Well diameter	5.46 ± 0.10 mm
Distance to center of A1 from top edge	8.75 ± 0.25 mm
Distance to center of A1 from left edge	10.75 ± 0.25 mm
Pitch (distance between A1 and A2)	9.00 mm

## Ordering Information

4ti-0750/TA	96 Well Non-Skirted PCR Plate, clear PP, breakable vertically, high profile, cut corner H12, 50 plates per case
4ti-0750/W/TA	96 Well Non-Skirted PCR Plate, white PP, breakable vertically, high profile, cut corner H12, 50 plates per case
4ti-0750/TA/12	96 Well Non-Skirted PCR Plate, clear PP, breakable horizontally, high profile, cut corner H12, 50 plates per case

For recommended plate options depending on manufacturer, block type, and instrument please refer to the Azenta Plate Instrument Compatibility Table Page 187.

# Instrument Compatibility Table



# Instrument Compatibility Table

## FrameStar Polypropylene & Polycarbonate PCR Plates

Skirt		skirted			semi-skirted				
Number of wells		384	384	96	96	96	96	96	96
High/Low Profile		/	/	L	L	L	H	H	H
Product code/Short description		4ti-0384 FrameStar 384	4ti-0380 FrameStar 384 Roche	4ti-0960 FrameStar 96	4ti-0950 & 4ti-0954 FrameStar 96 Roche	4ti-0910 FrameStar 96 FastPlate	4ti-0730 FrameStar 96 ABI®	4ti-0770 FrameStar 96c ABI®	4ti-0900 FrameStar 96
<b>ABI® / LIFE TECHNOLOGIES / THERMO FISHER SCIENTIFIC</b>									
Thermal Cyclers	96 well standard block	Veriti, Proflex, Simplicamp					✓	△	
		GeneAmp® 2700 / 2720 / 9600 / 9700					✓	△	
	96 well FAST block	GeneAmp® 9800 FAST, Veriti FAST				△			
	384 well block	GeneAmp® 9700, Veriti, Proflex, Multiblock system	△						
qPCR Cyclers	96 well standard block	7000, 7300, 7500, 7700, 7900 HT					✓	△	
		QuantStudio™ 3 / 5 / 6 / 7 / 12K, ViiA7™					✓	△	
	96 well FAST block	StepOne							
		StepOne Plus™					△		
		7500 FAST, 7900 HT FAST					△		
384 well block	QuantStudio™ 3 / 5 / 6 / 7 / 12K, ViiA7™ 7900 HT FAST	△							
Sequencers	96 well block	3100, 3130XL, 3500, 3500XL, 3730, 3730XL					△	✓	
	384 well block	3100, 3130XL, 3500, 3500XL, 3730, 3730XL	△						
<b>AGILENT / STRATAGENE</b>									
Thermal Cyclers	96 well block	Surecycler 8800							
	384 well block	SureCycler 8800	△						
	96 well block	Robocycler Gradient			△				✓
qPCR Cyclers	96 well block	AriaMx			△				
		Mx3000P™ Mx3005P™						△	✓
		Mx4000™					✓	△	
<b>ANALYTIK JENA / BIOMETRA</b>									
Thermal Cyclers	Strips only	TRIO, Tpersonal, T3 Thermocycler							
	96 well block	Flexcycler2, T1 Thermocycler, Tgradient, Tone, Tadvanced, TProfessional (Standard/Basic) Gradient/XL			△			✓	✓
		Trobot 96, SpeedCycler2 (SP, SPR)			△			✓	✓
384 well block	Flexcycler2, T1 Thermocycler, Tadvanced, TProfessional, Trobot 96	△							
qPCR Cyclers	96 well block	qTOWER³ / G / touch, Topical						△	✓
	384 well block	qTOWER³ 84 / 84G	△						
<b>BIOER TECHNOLOGIES</b>									
Thermal Cyclers	Strips only	GeneQ							
	96 well block	Gene Touch 96						△	✓
	384 well block	Gene Touch 384	△						
<b>BIO-RAD</b>									
Thermal Cyclers	Strips only	Genecycler							
	96 well block	C1000 Touch, S1000			△			✓	✓
		iCycler™ MyCycler™, T100						△	✓
384 well block	C1000 Touch, S1000	△							
qPCR Cyclers	96 well block	CFX96 Touch, CFX96 Touch Deep Well, CFX connect			△				
		MyiQ™ iCycler™ IQ / IQ.4 / IQ.5						△	✓
	384 well block	CFX384 Touch	△						

<sup>1</sup> Short product code shown only (without details on frame and well color), please refer to the corresponding product page for ordering details of all variations available.

<sup>2</sup> For compatibility information of the PCR Plate for Removable 8 Well Tube Strips please refer to the table entry for the respective PCR Plate for Removable 8 Well Tube Strips frame.

△ Recommended option ✓ Compatible • Should be compatible, please check with your specific instrument/block ✱ Compatible with PCR Plates Breakable Horizontally or Vertically only

Azenta US, Inc. recognizes that designated trademarks and brands are the property of their respective owners.

FrameStar PCR Plates, Individually Accessible Plate, PCR Tube Strips								Standard PCR Plates and Strips													
non skirted		Breakable Vertically		Breakable Vertically & Horizontally		skirted	strips	skirted			semi-skirted			non-skirted	strips					strips	
96	96	96	96	96	96	96	8	384	384	96	96	96	96	96	8	8	8	8	8	8	4
H	L	H	L	H	L	L	H	/	/	L	H	L	H	H	H	L	H	L	H	L	/
41i-0710 FrameStar 96	41i-0720 FrameStar 96	41i-1000 FrameStar Breakable Vertically	41i-1200 FrameStar Breakable Vertically	41i-1300 FrameStar Breakable Vertically & Horizontally	41i-1400 FrameStar Breakable Vertically & Horizontally	41i-0960/RA Individual Access 96	41i-0785 & 41i-0786 PCR Tube Strips & Well	41i-1384 384 Well	41i-1381 384 Well Roche	41i-0740 96 Well	41i-0760 96 Well	41i-0955 96 Well Roche	41i-0735 96 Well ABI®	41i-0750 - 96 Well 41i-0750/TA- dividable	41i-0781 8 Well	41i-0753 PCR Tube Strip	41i-0792 8 Well, Attached Flat Caps	41i-0793 8 Well, Attached Flat Caps	41i-0794 8 Well, Attached Domed C.	41i-0796 4 Well Rotor-Gene®	
		✓		✓			✓				✓		✓	✓	✓		✓		✓		
✓		✓		✓			✓				✓		✓	✓	✓		✓		✓		
			✓		✓																
✓		✓		✓			✓	✓			✓		✓	✓	✓		✓				
			✓		✓											△					
			✓		✓											✓			✓		
✓		✓		✓				✓			✓		✓						✓		
✓		✓		✓				✓			✓		✓						✓		
△														✓	✓						
✓			✓		✓	✓		✓		✓				✓		✓			✓		
	✓		✓		✓	✓				✓						✓			✓		
✓		✓		✓			✓				✓			✓	✓	✓			✓		
✓		✓		✓			✓				✓			✓	✓	✓			✓		
		△		✓			✓							*	✓		✓		✓		
✓		✓		✓			✓				✓			✓	✓		✓		✓		
								✓													
		△		✓			✓							*	✓		✓		✓		
✓		✓		✓			✓				✓			✓	✓		✓		✓		
✓	✓	✓	✓	✓	✓	✓	✓			✓	✓			✓	✓	✓	✓	✓	✓	✓	✓
✓		✓		✓			✓				✓			✓	✓	✓	✓	✓	✓	✓	✓
	✓		✓		✓	✓				✓						✓			✓		
✓		✓		✓			✓				✓					✓			✓		

The individual instrument-plate compatibility information is for guidance only. Samples of all plates are available before purchase to ensure compatibility. Please check installed heat block, refer to instruments manual for details or contact our technical support.

Azenta recognises that designated trademarks and brands of the Instrument Compatibility Table are the property of their respective owners.

# Instrument Compatibility Table

## FrameStar Polypropylene & Polycarbonate PCR Plates

Skirt			skirted			semi-skirted					
Number of wells			384	384	96	96	96	96	96		
High/Low Profile			/	/	L	L	L	H	H		
Product code/Short description			44i-0384 FrameStar 384	44i-0380 FrameStar 384 Roche	44i-0960 FrameStar 96	44i-0950 & 44i-0954 FrameStar 96 Roche	44i-0910 FrameStar 96 FastPlate	44i-0730 FrameStar 96 ABI®	44i-0770 FrameStar 96 ABI®	44i-0900 FrameStar 96	
<b>BIO-RAD MJ RESEARCH</b>											
Thermal Cyclers	Strips only	Mini Gradient									
	96 well block	Personal								△	
		PTC100™ / 200™ / 220™ / 221™ / 225™ / 240™				△				✓	✓
384 well block	PTC200™ / 220™ / 221™ / 225™ / 240™		△								
qPCR Cyclers	Strips only	MiniOpticon									
	96 well block	Chromo4™			△				✓	✓	
Opticon2™				△							
<b>CORBETT RESEARCH</b>											
Thermal Cyclers	96 well block	(Diagen) Palm Cyclers							△	✓	
	384 well block	(Diagen) Palm Cyclers 384		△							
qPCR Cycl.	Strips only	Rotor-Gene series									
<b>EPPENDORF</b>											
Thermal Cyclers	96 well block	MasterCycler® ep / ep gradient / Pro / Pro S / nexus / nexus gradient / nexus SX1 / nexus GSX1			△				✓	✓	
		MasterCycler® nexus X2 / GX2 / GX2e / X2e									
	384 well block	MasterCycler® ep 384 / Pro 384		△							
qPCR Cycl.	96 well block	Mastercycler™ ep realplex			△				✓	✓	
<b>GE HEALTHCARE / AMERSHAM</b>											
Sequencers	96 well block	MegaBACE™ 500, MegaBACE™ 1000 mark 2			△						
	384 well block	MegaBACE™ 4000		△							
<b>PEQLAB / VWR</b>											
Thermal Cyclers	Strips only	peqSTAR XS, peqSTAR 2X									
	96 well block	peqSTAR 96X			△				✓	✓	
	384 well block	peqSTAR 384X		△							
<b>ROCHE</b>											
qPCR Cyclers	96 well block	LC96, LC480				△					
	384 well block	LC480		△							
	Strips only	Nano									
<b>SENSOQUEST</b>											
Thermal Cyclers	96 well block	Labcycler			✓		✓	✓	✓	✓	
	384 well block	Labcycler		△							
<b>TAKARA</b>											
Thermal Cycl.	96 well block	Dice touch, Gradient							△	✓	
<b>TECHNE</b>											
Thermal Cyclers	Strips only	3Prime, 3PrimeG, 3PrimeX									
		Prime, PrimeG, Prime Elite, Prime Elite Satellite							△	✓	
	96 well block	PCRmax Alpha cycler 1 / 2 / 4							△	✓	
		TC412, TC512, Genius, Genius Quad, Touchgene, Touchgene Gradient, Flexigene			△				✓	✓	
	384 well block	Prime, PrimeG, Prime Elite, Prime Elite Satellite		△							
		PCRmax Alpha cycler 1 / 2 / 4		△							
		TC412, TC512, Genius, Genius Quad, Flexigene		△							
qPCR Cycl.	96 well block	Quantica			△						

<sup>1</sup> Short product code shown only (without details on frame and well color), please refer to the corresponding product page for ordering details of all variations available.

<sup>2</sup> For compatibility information of the PCR Plate for Removable 8 Well Tube Strips please refer to the table entry for the respective PCR Plate for Removable 8 Well Tube Strips frame.

△ Recommended option ✓ Compatible • Should be compatible, please check with your specific instrument/block ✱ Compatible with PCR Plates Breakable Horizontally or Vertically only

Azenta US, Inc. recognizes that designated trademarks and brands are the property of their respective owners.

FrameStar PCR Plates, Individually Accessible Plate, PCR Tube Strips								Standard PCR Plates and Strips													
non skirted		Breakable Vertically		Breakable Vertically & Horizontally		skirted	strips	skirted			semi-skirted			non-skirted	strips					strips	
96	96	96	96	96	96	96	8	384	384	96	96	96	96	96	8	8	8	8	8	8	4
H	L	H	L	H	L	L	H	/	/	L	H	L	H	H	H	L	H	L	H	L	/
41i-0710 FrameStar 96	41i-0720 FrameStar 96	41i-1000 FrameStar Breakable Vertically	41i-1200 FrameStar Breakable Vertically	41i-1300 FrameStar Breakable Vertically & Horizontally	41i-1400 FrameStar Breakable Vertically & Horizontally	41i-0960/RA Individual Access 96	41i-0785 & 41i-0786 PCR Tube Strips & Well	41i-1384 384 Well	41i-1381 384 Well Roche	41i-0740 96 Well	41i-0760 96 Well	41i-0955 96 Well Roche	41i-0735 96 Well ABI®	41i-0750 - 96 Well 41i-0750/TA - dividable	41i-0781 8 Well	41i-0753 PCR Tube Strip	41i-0792 8 Well, Attached Flat Caps	41i-0793 8 Well, Attached Flat Caps	41i-0794 8 Well, Attached Domed C.	41i-0796 4 Well Rotor-Gene®	
		△		✓			✓							*	✓		✓		✓		
✓										✓	✓			✓	✓	✓	✓	✓	✓	✓	
✓	✓	✓	✓	✓	✓	✓	✓			✓	✓			✓	✓	✓	✓	✓	✓	✓	
								✓													
✓	✓	✓	✓	✓	✓	✓	✓			✓	✓			✓	✓	△			✓		
✓		✓		✓			✓				✓			✓	✓			✓		✓	
								✓													△
✓	✓	✓	✓	✓	✓	✓	✓			✓	✓			✓	✓	✓	✓	✓	✓	✓	
	✓		✓		✓					✓						✓					
✓	✓	✓	✓	✓	✓	✓	✓			✓	✓			*	✓	✓	✓	✓	✓	✓	
								✓													
												✓				✓					
✓	✓	✓	✓	✓	✓	✓	✓			✓	✓			✓	✓	✓	✓	✓	✓	✓	
								✓													
✓		✓		✓			✓				✓			✓	✓				✓		
✓		△		✓			✓							*	✓		✓		✓		
✓		✓		✓			✓				✓			✓	✓		✓		✓		
✓	✓	✓	✓	✓	✓	✓	✓			✓	✓			✓	✓	✓	✓	✓	✓	✓	
								✓													
								✓													
	✓		✓		✓	✓				✓						✓			✓		

The individual instrument-plate compatibility information is for guidance only. Samples of all plates are available before purchase to ensure compatibility. Please check installed heat block, refer to instruments manual for details or contact our technical support.

Azenta recognises that designated trademarks and brands of the Instrument Compatibility Table are the property of their respective owners.





**AZENTA**  
LIFE SCIENCES

# Storage Plates

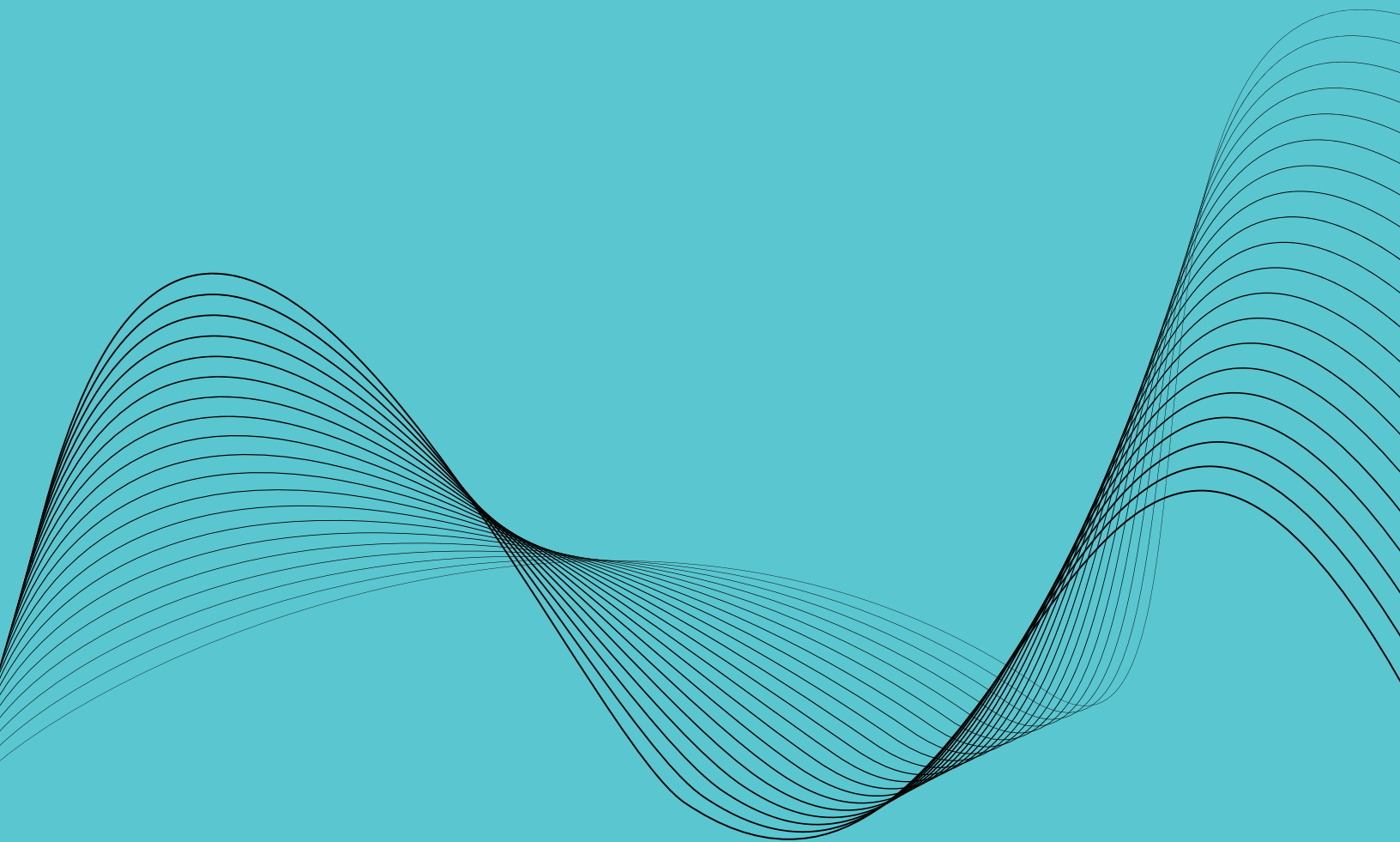

# 384 Square Deep Well Storage Microplate

## 190 µl square wells, V shaped bases, clear polypropylene

- This plate is designed for high density sample collection and storage, for a wide array of applications within cell biology, molecular biology and drug discovery
- The V shaped wells allow for complete sample retention with pipettes, and are ultra-flat for a completely uniform seal, either with adhesive or heat seals, or (4ti-0139)
- Our plates are manufactured in cleanroom facilities which are certified free of RNase, DNase, human genomic DNA and endotoxins
- We use only the highest medical grade virgin polypropylene with high resistance against chemicals such as DMSO, phenol, and chloroform

## Key Features

- Made from polypropylene, a material with very low biomolecular binding characteristics, a high temperature tolerance and resistance to many standard laboratory chemicals, including DMSO
- Autoclavable
- Free from DNase, RNase, human genomic DNA, and endotoxin

## Wells

- Square wells, to make the best use of space, and to improve mixing
- Conical V-bottoms

## Frame

- Alphanumeric grid reference to aid well and sample identification
- SBS footprint

## Use

- Clear plate, perfect for storage applications
- Temperature range for use: -80°C to 120°C
- Best for precipitation, centrifugation and small volume recovery due to the conical V bottom, as the liquid gathers at the lowest point of the V for easy pipetting
- Stackable
- Suitable for adhesive and heat sealing

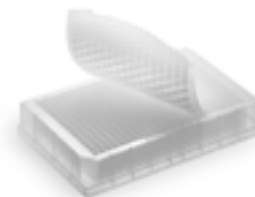

## Options

- Non-gamma treated as standard, gamma treatment available upon request; contact us for details and pricing
- Available barcoded upon request
- A clear silicone sealing mat (4ti-0139) is also available to fit this product, with 384 sections to correspond with the wells of this plate
- Ultra-low DNA binding option available (4ti-LB0147) for sensitive applications with ultra-low DNA input and for maximum DNA recovery after low temperature storage and high temperature incubation

## Ordering Information

<b>4ti-0147</b>	<b>384 Square Deep Well Storage Microplate</b> , 190µl square wells, V-shaped bottom, clear PP, 100 plates per case
<b>4ti-LB0147</b>	<b>384 Square Deep Well Storage Microplate</b> , <b>low binding</b> , 190µl square wells, V-shaped bottom, clear PP, 100 plates per case
<b>Related Products</b>	
<b>4ti-0139</b>	<b>384 Square Well Sealing Cap Mat</b> , clear silicone, for use with square 384 well microplates and deep well storage microplates, 50 mats per case



# 96 Square Deep Well Storage Microplate

**1.2 ml and 2.2 ml square wells, U and V shaped bottom, clear polypropylene**

- These storage plates are designed for high density sample collection and storage for a wide array of applications within cell biology, molecular biology and drug discovery
- They come in three formats: 1.2 ml volume U shaped well plates (4ti-0126), 2.2 ml volume V shaped (4ti-0132), and 2.2 ml volume U shaped (4ti-0136) plates
- All of these plates are ultra-flat for a completely uniform seal, either with adhesive or heat seals, or with our accompanying silicone sealing mat (4ti-0137)
- These plates are manufactured in cleanroom facilities which are certified free of RNase, DNase, human genomic DNA and endotoxins
- We use only the highest medical grade virgin polypropylene with high resistance against chemicals such as DMSO, phenol, and chloroform

## Key Features

- Made from polypropylene, a material with very low biomolecular binding characteristics, a high temperature tolerance and resistance to many standard laboratory chemicals, including DMSO
- Autoclavable
- Free from RNase, DNase, human genomic DNA and endotoxins

## Wells

- Conical V-bottoms (4ti-0132) and U-shaped bottoms (4ti-0126 and 4ti-0136)
- Square wells, to make the best use of space, and to improve mixing

## Frame

- Alphanumeric grid reference to aid well and sample identification
- SBS footprint

## Use

- Clear plate, perfect for storage applications
- Temperature range for use: -80°C to 120°C
- Best for precipitation, centrifugation and small volume recovery due to the conical V bottom, as the liquid gathers at the lowest point of the V for easy pipetting
- U-shaped bottom plates are best for washing, mixing and pelleting and give high surface area
- Stackable
- Suitable for adhesive and heat sealing



## Options

- Available with a U-shaped bottom in 1.2 ml and 2.2 ml
- Also available with a V-shaped bottom in 2.2 ml
- Non-gamma treated as standard, gamma treatment available upon request; contact us for details and pricing
- Available barcoded upon request
- A clear silicone sealing mat (4ti-0137) is also available to fit these plates

## Ordering Information

<b>4ti-0126</b>	<b>96 Square Deep Well Storage Microplate, 1.2ml square wells, U-shaped bottom, clear PP, 100 plates per case</b>
<b>4ti-0132</b>	<b>96 Square Deep Well Storage Microplate, 2.2ml square wells, V-shaped bottom, clear PP, 50 plates per case</b>
<b>4ti-0136</b>	<b>96 Square Deep Well Storage Microplate, 2.2ml square wells, U-shaped bottom, clear PP, 50 plates per case</b>
<b>Related Products</b>	
<b>4ti-0137</b>	<b>96 Square Well Sealing Cap Mat, clear silicone, for use with square 96 well microplates and deep well storage microplates, 50 mats per case</b>



**AZENTA**  
LIFE SCIENCES

# 96 Round Deep Well Storage Microplate

## 1.2 ml or 2.0 ml round wells, U-shaped bottom, clear polypropylene

- These 96 deep well storage microplates are suitable for many manual and automated protocols, such as the Illumina® library and sample preparations, due to the plates' SBS footprint
- Additionally, they are suitable for use on magnetic plates for bead separation protocols
- Our round deep well storage microplates are available in two types of well volumes: 1.2 ml wells (4ti-0120) and 2.0 ml wells (4ti-0130)
- Both of these plates are ultra-flat for a completely uniform seal, either with our adhesive or heat seals, or with our accompanying silicone sealing mats (4ti-0135 mat for the 1.2 ml plate ; 4ti-0138 mat for the 2.0 ml plate)
- Our plates are manufactured in cleanroom facilities which are certified free of RNase, DNase, human genomic DNA and endotoxins
- We use only the highest medical grade virgin polypropylene with high resistance against chemicals such as DMSO, phenol, and chloroform

## Key Features

- Made from polypropylene, a material with very low biomolecular binding characteristics, a high temperature tolerance and resistance to many standard laboratory chemicals, including DMSO
- Autoclavable
- Free from RNase, DNase, human genomic DNA and endotoxins

## Wells

- Round wells, suitable for most applications as they reduce droplet effects and wicking
- U-shaped bottoms

## Frame

- Alphanumeric grid reference to aid well and sample identification
- SBS footprint

## Use

- Clear plate, perfect for storage applications
- Suitable as a collection plate from filter systems
- Temperature range for use: -80°C to 120°C
- U-shaped bottom plates are best for washing, mixing and pelleting and give high surface area
- Stackable
- Suitable for adhesive and heat sealing



## Options

- Available with 1.2 ml and 2.0 ml wells
- Non-gamma treated as standard, gamma treatment available upon request; contact us for details and pricing
- Available barcoded upon request
- 2 clear silicone sealing mats (4ti-0135 and 4ti-0138) are also available to fit these plates

## Ordering Information

<b>4ti-0120</b>	<b>96 Round Deep Well Storage Microplate, 1.2ml round wells, U-shaped bottom, clear PP, 50 plates per case</b>
<b>4ti-0130</b>	<b>96 Round Deep Well Storage Microplate, 2.0ml round wells, U-shaped bottom, clear PP, 50 plates per case</b>
<b>Related Products</b>	
<b>4ti-0135</b>	<b>96 Round Well Sealing Cap Mat, white silicone, for use with 4TI-0120 only, 100 mats per case</b>
<b>4ti-0138</b>	<b>96 Round Well Sealing Cap Mat, clear silicone, for use with round 96 well microplates and deep well storage microplates (not for use with 4ti-0120 and 4ti-0110), 50 mats per case</b>



# 96 Round Deep Well Storage Microplate, For Magnetic Separators

## 1 ml round wells, V-shaped bottom, clear polypropylene

- These 96 deep well storage microplates are especially designed for use with magnetic separators for bead separation protocols
- Due to the special shape of the stacking ribs, the plate sits much lower on the magnetic separator than standard round well plates thus facilitating the speed and efficiency of the separation process
- The plates are ultra-flat for a completely uniform seal; sealing possible with either adhesive or heat seals

## Key Features

- Made from polypropylene, a material with very low biomolecular binding characteristics, a high temperature tolerance and resistance to many standard laboratory chemicals, including DMSO
- Autoclavable
- Free from RNase, DNase, human genomic DNA and endotoxins

## Wells

- Round wells: suitable for most applications, as they reduce droplet effects and wicking
- V-shaped bottom

## Frame

- Alphanumeric grid reference to aid well and sample identification
- SBS footprint

## Use

- Perfect fit to magnetic separators: the magnetic beads separate perfectly into e.g. a ring (if a ring magnet is used) allowing easy removal of supernatant from the center of the well by manual or automated pipetting
- Replaces the 96-well storage plates, round well, 0.8 ml (MIDI plate, Fisher Scientific® part number AB-0859), in e.g. Illumina® protocols
- Best for small volume recovery due to the V-shaped bottom, as the liquid gathers at the lowest point of the V for easy pipetting
- Compatible with plate readers and ideal for use with automation
- Temperature range for use: -80°C to 120°C

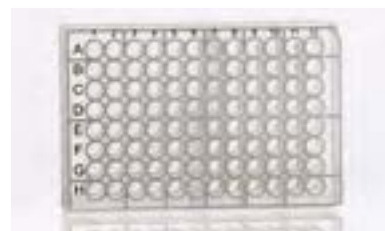

## Options

- Ultra-low DNA binding option available (4ti-LB0125) for sensitive applications with ultra-low DNA input and for maximum DNA recovery after low temperature storage and high temperature incubation
- Available barcoded upon request
- Non-gamma treated as standard, gamma treatment available upon request; contact us for details and pricing
- Silicone sealing cap mat (4ti-0124) available separately: efficiently prevents cross contamination and sample evaporation to ensure a high degree of sample security

## Ordering Information

<b>4ti-0125</b>	<b>96 Round Deep Well Storage Microplate, for magnetic separators, 1.0ml round wells, V-shaped bottom, clear PP, 50 plates per case</b>
<b>4ti-LB0125</b>	<b>96 Round Deep Well Storage Microplate, for magnetic separators, low binding, 1.0ml round wells, V-shaped bottom, clear PP, 50 plates per case</b>
<b>Related Products</b>	
<b>4ti-0124</b>	<b>96 Round well Sealing Cap Mat, clear silicone, for use with 4ti-0125, 50 mats per case</b>

# 96 Round Well Storage Microplate

200 µl, 300 µl, 330 µl or 350 µl round wells, U or V shaped bottom, clear polypropylene; also available as a low binding plate with ultra-low DNA binding properties

- These shallow 96 well storage microplates are particularly suitable for collection and preservation of samples widely used in cell biology research, molecular biology research, and drug discovery
- Four formats of this plate are available: a U-bottom plate with 300 µl or 330 µl well volumes (4ti-0110 and 4ti-0116 respectively), and a V-bottom plate with 200 µl or 330 µl well volume (4ti-LB0109 and 4ti-0117 respectively)
- Also available as a low binding plate with ultra-low DNA binding properties (4ti-LB0109) for sensitive applications such as Next Generation Sequencing sample preparation
- All of these plates are ultra-flat for a completely uniform seal, either with adhesive or heat seals, or with our accompanying silicone sealing mat (4ti-0138)
- These plates are manufactured in cleanroom facilities which are certified free of RNase, DNase, human genomic DNA and endotoxins
- We use only the highest medical grade virgin polypropylene with high resistance against chemicals such as DMSO, phenol, and chloroform

## Key Features

- Made from polypropylene, a material with very low biomolecular binding characteristics, a high temperature tolerance and resistance to many standard laboratory chemicals, including DMSO
- Autoclavable
- Free from RNase, DNase, human genomic DNA and endotoxins
- Low binding option made of selected low bind polymers, no coating is used to achieve the binding characteristics; they feature stacking ribs under the deck for improved stability, strengthening the plate for use in robotic automation applications

## Wells

- Conical V-bottoms (4ti-LB0109 and 4ti-0117) and U-shaped bottoms (4ti-0110 and 4ti-0116)
- Round wells, suitable for most applications as they reduce droplet effects and wicking

## Frame

- Alphanumeric grid reference to aid well and sample identification
- SBS footprint

## Use

- Clear plate, perfect for storage applications
- Suitable as a collection plate from filter systems
- Temperature range for use: -80°C to 120°C



- Best for precipitation, centrifugation and small volume recovery due to the V-shaped bottom, as the liquid gathers at the lowest point of the V for easy pipetting
- U-shaped bottom plates are best for washing, mixing and pelleting and give high surface area
- Stackable
- Suitable for adhesive and heat sealing

## Options

- Available with a U-shaped bottom in 300 µl and 330 µl, and with V-shaped bottom in 200 µl and 330 µl
- Ultra-low DNA binding option available (4ti-LB0109) for sensitive applications with ultra-low DNA input and for maximum DNA recovery after low temperature storage and high temperature incubation; learn more about our low binding range (not suitable for use on PCR blocks)
- Non-gamma treated as standard, gamma treatment available upon request; contact us for details and pricing
- Available barcoded upon request
- A clear silicone sealing mat (4ti-0138) is also available to fit these plates

## Ordering Information

<b>4ti-LB0109</b>	96 Round Well Microplate, low binding, 200ul round wells, V-shaped bottom, clear PP, 50 plates per case
<b>4ti-0110</b>	96 Round Well Microplate, 300ul round wells, U-shaped bottom, clear PP, 100 plates per case
<b>4ti-0116</b>	96 Round Well Microplate, 350ul round wells, U-shaped bottom, clear PP, 100 plates per case
<b>4ti-0117</b>	96 Round Well Microplate, 330ul round wells, V-shaped bottom, clear PP, 100 plates per case
<b>Related Products</b>	
<b>4ti-0138</b>	96 Round Well Sealing Cap Mat, clear silicone, for use with round 96 well microplates and deep well storage microplates (not for use with 4ti-0120 and 4ti-0110), 50 mats per case



**AZENTA**  
LIFE SCIENCES

# 12 Channel Reservoir Plate

## Pyramid channel bottom, clear polypropylene

- Our Reservoir Plates are perfect for storing volumes of samples to be pipetted into other microplates for further applications
- Both plate formats - open format and 12 column format - are compatible with standard 12 and 96 well channel pipettes, and are suitable for automated systems, for instance the PerkinElmer® Sciclone® NGS Workstation
- These plates are manufactured in cleanroom facilities which are certified free of RNase, DNase, human genomic DNA and endotoxins
- We use only the highest medical grade virgin polypropylene with high resistance against chemicals such as DMSO, phenol, and chloroform
- Pyramid channel bases are best for small volume recovery
- The standard SBS footprint ensures its compatibility with automation

## Key Features

- Made from polypropylene, a material with very low biomolecular binding characteristics, a high temperature tolerance and resistance to many standard laboratory chemicals, including DMSO
- Stackable
- Free from RNase, DNase, human genomic DNA and endotoxins

## Channels

- Pyramid channel bottom, perfect for maximum sample retrieval; both the open format plate (4ti-0133) and the 12 channel plate (4ti-0131) have pyramid bases
- Rectangular channels (4ti-0131), to ensure the best use of space and allow the use of multichannel pipettes

## Frame

- SBS footprint

## Use

- Perfect for maximum sample retrieval; even the smallest volume can be retrieved as it gathers in the base of the pyramid, and can be easily taken in by a pipette
- Compatible with plate readers and ideal for use with automation
- Suitable as a collection plate from filter systems
- Temperature range for use -80°C to 120°C



## Options

- Available barcoded upon request
- Non-gamma treated as standard, gamma treatment available upon request; contact us for details and pricing

## Ordering Information

<b>4ti-0131</b>	12 Channel Reservoir Plate, 21ml channels, pyramid bottom, clear PP, 25 plates per case
<b>4ti-0133</b>	12 Channel Reservoir Plate, 290ml open format, 12 channel pyramid bottom, clear PP, 25 plates per case



# 96 Square Well Microplate, KingFisher™ Style

## 200 µl square wells, V-shaped bottom, clear polypropylene

- Suitable for use with KingFisher Flex, Apex and Presto
- Ultra-flat deck and standard SBS footprint ensures its compatibility with automation

## Key Features

- Made from polypropylene, a material with very low biomolecular binding characteristics, a high temperature tolerance and resistance to many standard laboratory chemicals, including DMSO

## Wells

- Conical V-bottoms
- Square wells, to make the best use of space, and to improve mixing

## Frame

- Alphanumeric grid reference to aid well and sample identification
- SBS footprint

## Use

- Stackable
- Compatible with KingFisher system

## Options

- Non-gamma treated as standard, gamma treatment available upon request; contact us for details and pricing
- Available barcoded upon request

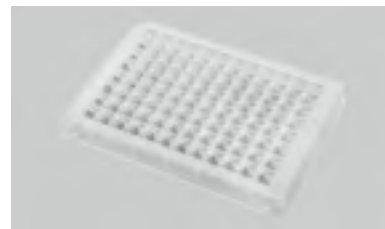

## Ordering Information

4ti-0151

Microplate KingFisher Style, 96 square  
200ul wells, V-shaped bottom, 50 plates  
per case

# 96 Square Deep Well Microplate, KingFisher™ Style

## 2.0 ml square wells, V-shaped bottom, clear polypropylene

- Suitable for use with KingFisher Duo Prime, Flex, Apex and Presto
- Designed for use with magnetic bead separators
- Ultra-flat deck and standard SBS footprint ensures its compatibility with automation

## Key Features

- Made from polypropylene, a material with very low biomolecular binding characteristics, a high temperature tolerance and resistance to many standard laboratory chemicals, including DMSO

## Wells

- Conical V-bottoms
- Square wells, to make the best use of space, and to improve mixing

## Frame

- Alphanumeric grid reference to aid well and sample identification
- SBS footprint

## Use

- Stackable
- Compatible with KingFisher system

## Options

- Non-gamma treated as standard, gamma treatment available upon request; contact us for details and pricing
- Available barcoded upon request



## Ordering Information

4ti-0150

Deep Well Microplate KingFisher Style,  
96 square 200ul wells, V-shaped bottom,  
50 plates per case



**AZENTA**  
LIFE SCIENCES

# 96 Tip Comb for Deep Well Magnets, KingFisher™ Style

## Clear polypropylene

- Suitable for use with KingFisher Flex, Apex and Presto

## Key Features

- Made from polypropylene, a material with very low biomolecular binding characteristics, a high temperature tolerance and resistance to many standard laboratory chemicals, including DMSO

## Use

- Suitable for use with 96 deep well magnets
- Compatible with KingFisher system

## Options

- Non-gamma treated as standard, gamma treatment available upon request; contact us for details and pricing
- Available barcoded upon request



## Ordering Information

4ti-0152

Comb for Deep Well Magnets KingFisher Style, 96 tips, 50 plates per case

# Assay Plates

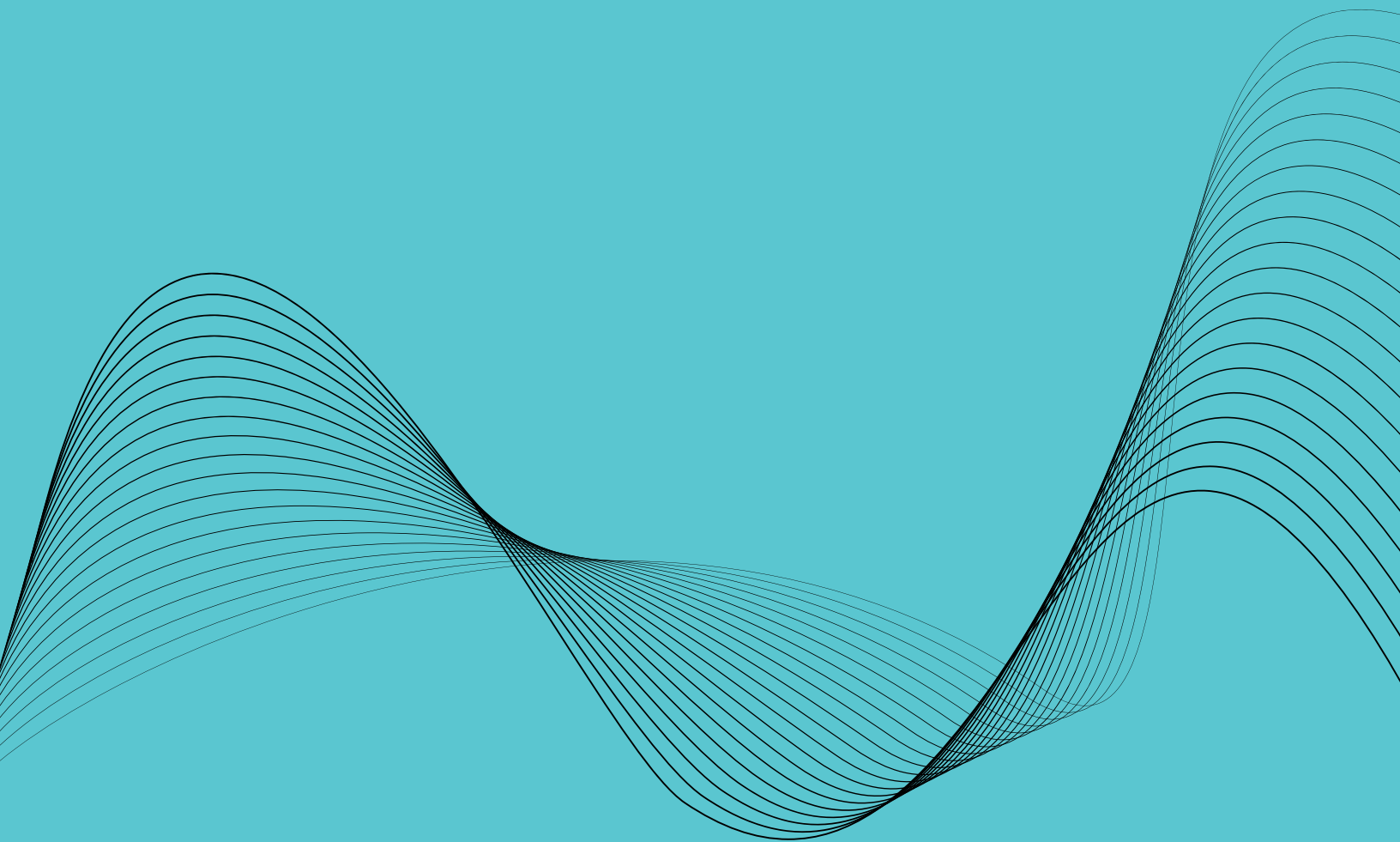

# 384 Well Optically Clear Tissue Culture Plate

## 190 µm clear base imaging microplate, black frame

- Optically Clear Tissue Culture Plates have been designed for high content screening (HCS) assays in drug development and related areas
- They are also suitable for homogeneous assays, employing fluorescence intensity, FRET and TR-FRET where measurements are bottom-read
- The high-quality optical base plate assures the necessary accuracy and consistency for automated high throughput systems, generating optimum signal-to-noise ratios
- Using state-of-the-art manufacturing technology, we have developed a product which offers several key advantages to the end user
- Optically Clear Tissue Culture Plates are assembled using unique patented laser welding technology which reduces autofluorescence and does not inhibit cell growth
- Available with 190 µm polystyrene base
- Available TC treated: our advanced tissue-culture (TC) treatment method evenly coats each well for optimal cell adhesion properties for highest reproducibility between wells, plates and batches

## Key Features

- Leak free
- Free from DNase, RNase, human genomic DNA, and cyto-toxic

## Wells

- Optimum signal-to-noise ratios
- Good cell adhesion
- Wicking and bubble formation eliminated

## Frame

- SBS footprint
- Alphanumeric grid reference

## Use

- Recommended for confocal microscopy due to reduced cross-talk and superior base flatness
- Reduced autofluorescence ensures their suitability for fluorescent assays
- Suitable for assays that measure absorbance in the visible light range (400-900 nm wavelengths)
- Suitable for colorimetric assays
- Suitable for homogeneous assays
- Suitable for use in BMG lab tech, Molecular Devices, Promega Glomax and other plate readers
- Suitable for adhesive and heat sealing: our Moisture Barrier Seal 384 (4ti-0516/384) is recommended as it is optically clear and allows repeated imaging without removal, reducing contamination risks



## Options

- Available with 190 µm polystyrene base
- All plates come sterilized, apart from 4ti-0204
- TC treated option available (4ti-0201)
- Collagen 1 treated option available (4ti-0205)
- Poly D-Lysine treated option available (4ti-0206)
- Available barcoded upon request

## Specifications

Parameter	Value
Plate length	127.76 ± 0.25 mm
Plate width	85.48 ± 0.25 mm
Plate height	14.35 ± 0.25 mm
Well depth	11.35 ± 0.25 mm
Well diameter	3.70 ± 0.10 mm
Distance to center of A1 from top edge	8.99 ± 0.25 mm
Distance to center of A1 from left edge	12.13 ± 0.25 mm
Pitch (distance between A1 and A2)	4.50 mm

## Ordering Information

4ti-0201	Optically Clear Tissue Culture Plate, 384 well, tissue culture treated, gamma treated, with lid, 190µm clear base, black frame, 24 plates and lids per case
4ti-0203	Optically Clear Tissue Culture Plate, 384 well, gamma treated, 190µm clear base, black frame, 30 plates per case
4ti-0204	Optically Clear Tissue Culture Plate, 384 well, 190µm clear base, black frame, 30 plates per case
Lids	
4ti-0280	Microplate 384 Lid, without condensation rings, clear, low profile, cut corner A1/P1, 100 lids per case
4ti-0281	Microplate 384 Lid, gamma treated, without condensation rings, clear, low profile, cut corner A1/P1, 100 lids per case



# 96 Well Optically Clear Tissue Culture Plate

## 190 µm clear base imaging microplate, black frame

- Optically Clear Tissue Culture Plates have been designed for high content screening (HCS) assays in drug development and related areas
- They are also suitable for homogeneous assays, employing fluorescence intensity, FRET and TR-FRET where measurements are bottom-read
- The high-quality optical base plate assures the necessary accuracy and consistency for automated high throughput systems, generating optimum signal-to-noise ratios
- Optically Clear Tissue Culture Plates are assembled using unique patented laser welding technology which reduces autofluorescence and does not inhibit cell growth
- Available with 190 µm polystyrene base
- Available TC treated: our advanced tissue-culture (TC) treatment method evenly coats each well for optimal cell adhesion properties for highest reproducibility between wells, plates and batches

## Key Features

- Leak free
- Free from DNase, RNase, human genomic DNA, and cyto-toxic

## Wells

- Optimum signal-to-noise ratios
- Good cell adhesion
- Wicking and bubble formation eliminated

## Frame

- SBS footprint
- Alphanumeric grid reference

## Use

- Recommended for confocal microscopy due to reduced cross-talk and superior base flatness
- Reduced autofluorescence ensures their suitability for fluorescent assays
- Suitable for assays that measure absorbance in the visible light range (400-900 nm wavelengths)
- Suitable for colorimetric assays
- Suitable for homogeneous assays
- Suitable for use in BMG lab tech, Molecular Devices, Promega Glomax and other plate readers
- Suitable for adhesive and heat sealing: our Moisture Barrier Seal 96 (4ti-0516/96) is recommended as it is optically clear and allows repeated imaging without removal, reducing contamination risks



## Options

- Available with 190 µm polystyrene base
- All plates come sterilized, apart from 4ti-0224
- TC treated option available (4ti-0221)
- Collagen 1 treated option available (4ti-0225)
- Poly D-Lysine treated option available (4ti-0226)
- Available barcoded upon request

## Specifications

Parameter	Value
Plate length	127.76 ± 0.25 mm
Plate width	85.48 ± 0.25 mm
Plate height	14.35 ± 0.25 mm
Well depth	10.8 ± 0.25 mm
Well diameter	6.3 ± 0.10 mm
Distance to center of A1 from top edge	11.24 ± 0.25 mm
Distance to center of A1 from left edge	14.38 ± 0.25 mm
Pitch (distance between A1 and A2)	9.00 mm

## Ordering Information

4ti-0221	Optically Clear Tissue Culture Plate, 96 well, tissue culture treated, gamma treated, with lid, 190µm clear base, black frame, 24 plates and lids per case
4ti-0223	Optically Clear Tissue Culture Plate, 96 well, gamma treated, 190µm clear base, black frame, 30 plates per case
4ti-0224	Optically Clear Tissue Culture Plate, 96 well, 190µm clear base, black frame, 30 plates per case
Lids	
4ti-0282	Microplate 96 Lid, with condensation rings, clear, low profile, cut corner A1/H1, 80 lids per case
4ti-0283	Microplate 96 Lid, gamma treated, with condensation rings, clear, low profile, cut corner A1/H1, 80 lids per case



# 24 Well Optically Clear Tissue Culture Plate

## 190 µm clear base imaging microplate, black frame

- Optically Clear Tissue Culture Plates have been designed for high content screening (HCS) assays in drug development and related areas
- They are also suitable for homogeneous assays, employing fluorescence intensity, FRET and TR-FRET where measurements are bottom-read
- The high-quality optical base plate assures the necessary accuracy and consistency for automated high throughput systems, generating optimum signal-to-noise ratios
- Using state-of-the-art manufacturing technology, we have developed a product which offers several key advantages to the end user
- Optically Clear Tissue Culture Plates are assembled using unique patented laser welding technology which reduces autofluorescence and does not inhibit cell growth
- Available with 190 µm polystyrene base
- Available TC treated: our advanced tissue-culture (TC) treatment method evenly coats each well for optimal cell adhesion properties for highest reproducibility between wells, plates and batches

## Key Features

- Leak free
- Free from DNase, RNase, human genomic DNA, and cyto-toxic

## Wells

- Optimum signal-to-noise ratios
- Good cell adhesion
- Wicking and bubble formation eliminated

## Frame

- SBS footprint
- Alphanumeric grid reference

## Use

- Recommended for confocal microscopy due to reduced cross-talk and superior base flatness
- Reduced autofluorescence ensures their suitability for fluorescent assays
- Suitable for assays that measure absorbance in the visible light range (400-900 nm wavelengths)
- Suitable for colorimetric assays
- Suitable for homogeneous assays
- Suitable for use in BMG lab tech, Molecular Devices, Promega Glomax and other plate readers
- Suitable for adhesive and heat sealing: our Moisture Barrier Seal 24 (4ti-0516/24) is recommended as it is optically clear and allows repeated imaging without removal, reducing contamination risks



## Options

- Available with 190 µm polystyrene base
- All plates come sterilized, apart from 4ti-0244
- TC treated option available (4ti-0241)
- Collagen 1 treated option available (4ti-0245)
- Poly D-Lysine treated option available (4ti-0246)
- Available barcoded upon request

## Specifications

Parameter	Value
Plate length	127.76 ± 0.25 mm
Plate width	85.48 ± 0.25 mm
Plate height	15.00 ± 0.25 mm
Well depth	12.50 ± 0.25 mm
Well diameter	14.50 ± 0.10 mm
Distance to center of A1 from top edge	15.74 ± 0.25 mm
Distance to center of A1 from left edge	18.88 ± 0.25 mm
Pitch (distance between A1 and A2)	18.00 mm

## Ordering Information

4ti-0241	Optically Clear Tissue Culture Plate, 24 well, tissue culture treated, gamma treated, with lid, 190µm clear base, black frame, 24 plates and lids per case
4ti-0243	Optically Clear Tissue Culture Plate, 24 well, gamma treated, 190µm clear base, black frame, 30 plates per case
4ti-0244	Optically Clear Tissue Culture Plate, 24 well, 190µm clear base, black frame, 30 plates per case
Lids	
4ti-0284	Microplate 24 Lid, with condensation rings, clear, low profile, cut corner A1, 80 lids per case
4ti-0286	Microplate 24 Lid, gamma treated, with condensation rings, clear, low profile, cut corner A1, 80 lids per case



# 384 Well Ultra Optically Clear Plates

## Ultra-clear based imaging microplate, black frame

- The main advantage of using Ultra Optically Clear Plates is in the optically ultra-clear base of the plate, which gives superior results by delivering low absorbance and high transmission, together with low background signals
- Not only this, but due to its incredible optical clarity, the ultra-clear base of the Ultra Optically Clear Plate delivers improved transmission of signals at low wavelengths compared to standard optical films
- It allows DNA measurements at 260/280 nm wavelengths in a medium or high throughput

## Key Features

- Free from DNase, RNase and human genomic DNA

## Base

- Ultra-clear base improves transmission for low wavelengths
- Peel-back film on the base for scratch free surface
- Optimum signal-to-noise ratios

## Frame

- Alphanumeric grid reference to aid well and sample identification

## Use

- Suitable for adhesive and heat sealing

## Options

- Available barcoded upon request
- Low profile lid available (4ti-0280)



## Ordering Information

<b>4ti-0214</b>	<b>Ultra Optically Clear Plate, 384 well,</b> clear base, black frame, 30 plates per case
<b>Lids</b>	
<b>4ti-0280</b>	<b>Microplate 384 Lid, without condensation rings, clear,</b> low profile, cut corner A1/P1, 100 lids per case





# 96 Well Ultra Optically Clear Plates

## Ultra-clear based imaging microplate

- The main advantage of using Ultra Optically Clear Plates is in the optically ultra-clear base of the plate, which gives superior results by delivering low absorbance and high transmission, together with low background signals
- Not only this, but due to its incredible optical clarity, the ultra-clear base of the Ultra Optically Clear Plate delivers improved transmission of signals at low wavelengths compared to standard optical films
- It allows DNA measurements at 260/280 nm wavelengths in a medium or high throughput

## Key Features

- Free from RNase, DNase and human genomic DNA

## Base

- Ultra-clear base improves transmission for low wavelengths
- Optimum signal-to-noise ratios

## Frame

- Alphanumeric grid reference to aid well and sample identification

## Use

- Suitable for adhesive and heat sealing

## Options

- Available barcoded upon request
- Lid available (4ti-0290)

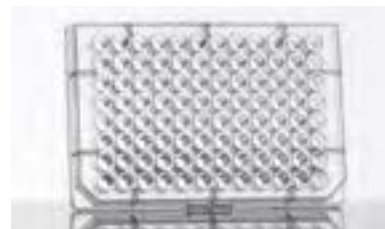

## Ordering Information

<b>4ti-0234</b>	<b>Ultra Optically Clear Plate, 96 well,</b> clear base, clear frame, 30 plates per case
<b>Lids</b>	
<b>4ti-0290</b>	<b>Universal Microplate Lid, without</b> <b>condensation rings, clear, low profile,</b> no cut corner, 50 lids per case



# 24 Well Assay Plate

## 1.88 ml round wells, flat base, polystyrene, cut corner A1

- The Azenta 24 well polystyrene assay plates have flat bottom wells and have been designed for fluorescence applications
- The plates give optimum results for most top-reading instruments and conform to standard SBS footprint
- Black plates have a low background fluorescence and minimize light scattering
- This high quality plate assures the necessary accuracy and consistency for automated high throughput systems

## Key Features

- Made from polystyrene, a hard material with optical clarity
- Non-gamma treated as standard
- Leak-free
- Free from DNase, RNase, human genomic DNA, and endotoxin/pyrogen

## Wells

- Flat bottom wells, designed for optical imaging and cell culture application
- Round wells, for reduced droplet effects and wicking

## Frame

- Alphanumeric grid reference to aid well and sample identification
- SBS footprint

## Use

- Best used for cell culture, fluorescence, luminescence, imaging and light assays, ELISA, and homogeneous assays
- Compatible with plate readers and ideal for use with automation

## Options

- Available as a black microplate, ideal for low background fluorescence; it minimizes light scattering, suitable for fluorescent and light assays and imaging, recommended for top reading fluorescence instrumentation
- Gamma treatment available upon request
- Available barcoded upon request
- Our Moisture Barrier Seal 24 (4ti-0516/24) is recommended as sealing option, as it is optically clear and allows repeated imaging without removal, reducing contamination risks
- Lids available



## Specifications

Parameter	Value
Plate length	127.76 ± 0.25 mm
Plate width	85.48 ± 0.25 mm
Plate height	15.00 ± 0.25 mm
Well depth	12.50 ± 0.25 mm
Well diameter	14.50 ± 0.10 mm
Distance to center of A1 from top edge	15.74 ± 0.25 mm
Distance to center of A1 from left edge	18.88 ± 0.25 mm
Pitch (distance between A1 and A2)	18.00 mm

## Ordering Information

<b>4ti-0262</b>	<b>24 Well Assay Plate, 1.88ml round wells, flat base, black PS, cut corner A1, 100 plates per case</b>
Lids	
<b>4ti-0284</b>	<b>Microplate 24 Lid, with condensation rings, clear, low profile, cut corner A1, 80 lids per case</b>
<b>4ti-0286</b>	<b>Microplate 24 Lid, gamma treated, with condensation rings, clear, low profile, cut corner A1, 80 lids per case</b>



# 96 Well Assay Plate

## 0.35 ml round wells, flat base, polystyrene, cut corner A1/H1

- The Azenta 96 well black assay plate has been specifically designed for fluorescence and scintillation applications
- It is also suitable for homogeneous assays employing fluorescence intensity, FRET and TR-FRET where measurements are top-read
- This high quality plate assures the necessary accuracy and consistency for automated high throughput systems, generating optimum signal to noise ratios
- The white assay microplates have been designed for luminescence applications, such as Luciferase Reporter Assays
- The white plate maximizes signal intensity in cases of low signal from some or all the wells, and it is designed to give optimum results for most top reading instruments, and to conform to standard SBS footprint

## Key Features

- Made from polystyrene, a hard material with optical clarity
- Leak-free
- Free from DNase, RNase, human genomic DNA, and endotoxin/pyrogen

## Wells

- Flat bottom wells, suitable for optical imaging and cell culture application
- Round wells, for reduced droplet effects and wicking

## Frame

- Alphanumeric grid reference to aid well and sample identification
- SBS footprint

## Use

- Best used for cell culture, fluorescence, luminescence, imaging and light assays, ELISA, and homogeneous assays
- Recommended for top reading fluorescence instrumentation
- Compatible with plate readers and ideal for use with automation

## Options

- Available as a black plate, for low background fluorescence and minimum light scattering
- Also available as a white microplate, for low background fluorescence and minimization of light scattering; suitable for fluorescent and light assays and imaging, and recommended for top reading fluorescence instrumentation
- Non-gamma treated as standard; gamma treatment available upon request
- Available barcoded upon request



- Our Moisture Barrier Seal 96 (4ti-0516/96) is recommended as a sealing option, as it is optically clear and allows repeated imaging without removal, reducing contamination risks
- Lids available

## Specifications

Parameter	Value
Plate length	127.76 ± 0.25 mm
Plate width	85.48 ± 0.25 mm
Plate height	14.35 ± 0.25 mm
Well depth	10.8 ± 0.25 mm
Well diameter	6.3 ± 0.10 mm
Distance to center of A1 from top edge	11.24 ± 0.25 mm
Distance to center of A1 from left edge	14.38 ± 0.25 mm
Pitch (distance between A1 and A2)	9.00 mm

## Ordering Information

<b>4ti-0263</b>	<b>96 Well Assay Plate, 0.35ml round wells, flat base, black PS, cut corner A1/H1, 100 plates per case</b>
<b>4ti-0273</b>	<b>96 Well Assay Plate, 0.35ml round wells, flat base, white PS, cut corner A1/H1, 100 plates per case</b>
<b>Lids</b>	
<b>4ti-0282</b>	<b>Microplate 96 Lid, with condensation rings, clear, low profile, cut corner A1/H1, 80 lids per case</b>
<b>4ti-0283</b>	<b>Microplate 96 Lid, gamma treated, with condensation rings, clear, low profile, cut corner A1/H1, 80 lids per case</b>

# 384 Well Assay Plate

## 0.12 ml rounded square wells, flat base, polystyrene, cut corner A1/P1

- The Azena 384 well black assay plate has been specifically designed for fluorescence and scintillation applications
- It is also suitable for homogeneous assays employing fluorescence intensity, FRET and TR-FRET where measurements are top-read
- This high quality plate assures the necessary accuracy and consistency for automated high throughput systems, generating optimum signal to noise ratios
- The 384 well white solid bottom assay microplate has been specifically designed for luminescence applications, such as Luciferase Reporter Assays
- It reduces well-to-well crosstalk, and the solid white color boosts signal in cases of low signal from some or all the wells
- The non-treated clear microplate is ideal for colorimetric assays and sample storage
- The rounded square wells eliminate wicking (capillary action)
- The flat bottom is ideal for optical reading

## Key Features

- Made from polystyrene, a hard material with optical clarity
- Leak-free
- Free from DNase, RNase, human genomic DNA, and endotoxin/pyrogen

## Wells

- Flat bottom wells, suitable for optical imaging and cell culture application
- Rounded square wells, to ensure the best use of space and improve sample mixing, suitable for small volumes
- Wicking and bubble formation eliminated

## Frame

- Alphanumeric grid reference to aid well and sample identification
- SBS footprint



## Use

- Best used for cell culture, fluorescence, luminescence, imaging and light assays, ELISA, and homogeneous assays
- Recommended for top reading fluorescence instrumentation
- Compatible with plate readers and ideal for use with automation
- Suitable for use in BMG labtech, Molecular Devices, Promega Glomax and other plate readers; for full instrument compatibility please contact us

## Options

- Black assay microplate, for low background fluorescence and minimum light scattering
- White microplate, for low background fluorescence and minimization of light scattering; suitable for fluorescent and light assays and imaging, and recommended for top reading fluorescence instrumentation
- The clear microplate offers the best solution for absorption, ELISA, spectrophotometric and colorimetric assays, and storage applications
- Non-gamma treated as standard; gamma treatment available upon request
- Available barcoded upon request
- Our Moisture Barrier Seal 384 (4ti-0516/384) is recommended as sealing option, as it is optically clear and allows repeated imaging without removal, reducing contamination risks
- Lids available



## 384 Well Assay Plate

### Specifications

Parameter	Value
Plate length	127.76 ± 0.25 mm
Plate width	85.48 ± 0.25 mm
Plate height	14.35 ± 0.25 mm
Well depth	11.35 ± 0.25 mm
Well diameter	3.70 ± 0.10 mm
Distance to center of A1 from top edge	8.99 ± 0.25 mm
Distance to center of A1 from left edge	12.13 ± 0.25 mm
Pitch (distance between A1 and A2)	4.50 mm

### Ordering Information

<b>4ti-0254</b>	<b>384 Well Assay Plate, 0.12ml rounded square wells, flat base, clear PS, cut corner A1/P1, 100 plates per case</b>
<b>4ti-0264</b>	<b>384 Well Assay Plate, 0.12ml rounded square wells, flat base, black PS, cut corner A1/P1, 100 plates per case</b>
<b>4ti-0274</b>	<b>384 Well Assay Plate, 0.12ml rounded square wells, flat base, white PS, cut corner A1/P1, 100 plates per case</b>
<b>Lids</b>	
<b>4ti-0280</b>	<b>Microplate 384 Lid, without condensation rings, clear, low profile, cut corner A1/P1, 100 lids per case</b>
<b>4ti-0281</b>	<b>Microplate 384 Lid, gamma treated, without condensation rings, clear, low profile, cut corner A1/P1, 100 lids per case</b>

# Microplate Sealing Consumables



# Microplate Sealing Consumables

Azenta offers a wide range of plate sealing solutions for whatever your requirements are. You can choose between sealing with strip caps, mats, lids, adhesive seals in strip or plate format, and heat seals in flexible formats up to plate size. The choice of an optimized sealing solution is particularly important for (q)PCR because thermal cycling can be associated with evaporation of reaction reagents.



## Heat Sealing & Adhesive Sealing

Dependent on your application requirements we offer a wide selection of materials to choose from within both our adhesive seal and heat seal ranges. You have the option to choose your seal based on a wide variety of properties offered, including peelability, pierceability, gas permeability, optical clarity, temperature stability and solvent resistance.

The best sealing results can be obtained by using flat rigid plates like FrameStar plates and heat seals, using reliable, high quality sealing instruments for seal application, like the Semi-Automated Sheet Heat Sealer or the Automated Roll Heat Sealer.

Alternatively, popular adhesive seals need to be applied well using a seal roller or seal applicator.

Azenta seals are produced and processed under strictly controlled environmental conditions and according to our ISO standard manufacturing. All of our seals are DNase, RNase, human genomic DNA, dust, endotoxin/pyrogen free. Dimensional and functional tests are performed on all production lots. If your seal of choice is not offered gamma treated as a stock product, then please contact us; we can offer custom gamma treatment of any seals if required.

## Caps, Lids & Mats

As an alternative to sealing films, Azenta offers multiple types of cap strips and individual well cap mats for sealing of both plates and tubes - domed and flat, strips of 8, strips of 12, and our new optically superior Strips of 8 Flat optically superior Crystal Clear caps.

A variety of rigid polystyrene lids are available for PCR plates and microplates, as well as silicone sealing mats for our storage plate range. We offer lids that are compatible with our FrameStar PCR plate range, and all assay plate ranges including the Optically Clear Plates range and Ultra Optically Clear Plates. The silicone cap mats are for use with our storage plates, and come in a variety of formats depending on the plate.



**AZENTA**  
LIFE SCIENCES

## Microplate Sealing Consumables

### Heat Sealing Consumables & Instrumentation

Heat sealing is the gold standard method of plate and tube sealing. It prevents sample loss and maximizes sample security, by ensuring a complete seal and preventing evaporation, leakage and contamination.

The sealing performance of heat seals is superior to all other methods including cap, mat and adhesive sealing. The variability of sealing integrity seen when using adhesive seals, caps or mats is reduced. The optimized sealing performance of a heat seal allows the use of smaller reagent volumes, leading to reagent cost savings and thus making heat sealing the most cost efficient sealing method for a wide range of applications.

Heat seals are available as sheets, for manual or semi-automated heat sealers, as well as in different roll formats for automated sealers. Azenta sealing consumables are compatible with a wide range of heat sealers, please refer to the Instrument Compatibility Table on page 187.

Depending on throughput, we recommend our Semi-Automated Sheet Heat Sealer (page 246) or Automated Roll Heat Sealer (page 244) for applying your heat seal.

In addition to instruments and consumables we also offer a Thermal Test Film for the optimization and troubleshooting of heat sealing applications.

### Economic efficiency

Investing in heat sealing solutions leads to a per plate reduction of sealing costs for all applications including storage, PCR and qPCR as shown in the table below for (q)PCR. The cost is further reduced by changing to the use of rolls seals rather than sheet seals.

Benefit of Heat Sealing	Why this is important
Enables a tight seal around each sample through melding of seal with sealing rings	Maintains sample integrity and minimizes evaporation
Achieves a consistent seal across the plate through unrivalled optimized sealing performance of Azenta heat sealers	Provides the ability to use the whole plate; Eliminates any potential for variation between wells as a result of evaporation
Fast and convenient application through touch of a button	Ability to seal a number of plates quickly and efficiently
No sample contamination through sealing materials, as seal surface is identical to well material	Sample contamination may affect the sample and resulting experiment

### Save your time

The application of heat seals is also easier and faster than when using caps or adhesive seals. Typical sealing times of a semi-automatic heat sealer, such as the Azenta Semi-Automated Sheet Heat Sealer, are around 2.5 seconds. A fully automatic roll heat sealer, such as the Azenta Automated Roll Heat Sealer, allows for sealing cycle times of less than 15 seconds.

### Set your standard

Reproducible sealing quality can be guaranteed by standardizing the sealing parameters: time, temperature and pressure. Azenta offers the widest choice of heat seal materials available, with sheet formats for manual or semi-automatic heat sealers and roll formats for automated heat sealers.

### Choose your application

Depending on the material of the plate (PP, PE, PS, COC, PC), the presence of solvents like DMSO in your sample and the storage or application temperatures required, we can offer a wide range of seals covering 100% DMSO storage and sealing integrity temperatures between -200°C to +120°C.

### Highest quality standards

Our seals are produced according to our ISO standard manufacturing. All of our seals are DNase, RNase, human genomic DNA, dust, endotoxin and pyrogen free. If your seal of choice is not offered gamma treated as a stock product then please contact us as we can offer custom gamma treatment of any seals if required.





# Clear Heat Seal

## Peelable heat sealing film, optically clear; suitable for qPCR and optical applications

- Heat sealing offers a 100% effective method for plate sealing for a complete seal integrity, as well as being quick and cost effective
- Our Clear Heat Seal is an optically clear laminate film forming a peelable seal to polypropylene, polyethylene, polystyrene, polycarbonate and cyclic olefin copolymer (COC) plate
- Samples can also be accessed by pre-piercing with a blade, needle or our Pierce Plate (4ti-0398)
- The optical clarity of this seal enables its use for sealing plates required for imaging use, including fluorescent detection methods such as qPCR and colorimetric assays
- The Clear Heat Seal forms a complete seal to a plate enabling both low temperature uses, including low temperature storage, and high temperature uses, such as PCR (when used with a pressurized heated lid)
- This seal demonstrates moderate solvent resistance and can be utilized for short term compound storage at room temperature
- This seal is available as sheets, for use with manual and semi-automated sealers such as our Semi-Automated Sheet Heat Sealer
- Also available in multiple roll formats compatible with specified automated heat sealers such as our Automated Roll Heat Sealer
- Our sheet seals are inter-leaved with paper sheets to help denote which side is the sealing side and aid removal of one sheet at a time from the pack
- For applications requiring high tensile strength (e.g. bead mill applications) please see our Clear Heat Seal Plus

## Key Features

- Peelable
- Seal integrity range: -80°C to 80 °C (to 110°C with a pressurized heated PCR lid)
- Optically clear
- Free from DNase, RNase, human genomic DNA, and endotoxin/pyrogen

## Use

- Applications: imaging, fluorescent detection, and colorimetric assays
- Suitable for PCR and qPCR
- Seals polypropylene, polyethylene, polystyrene, polycarbonate and cyclic olefin copolymer (COC) plates



\*110°C with pressurized heated lid



## Options

- Sheet format: 125 x 78 mm, to fit all standard SBS footprint PCR and qPCR plates, microplates, assay and storage plates, from 12 well to 1536 well
- Roll format: available in a variety of roll dimensions, to suit your choice of automatic heat sealing equipment
- Non-gamma treated as standard; gamma treatment available upon request
- Also available with our FrameSeal™ technology, a disposable, rigid, plastic frame perfect for use with a robotic gripper to be used within an automation cell

## Ordering Information

4ti-0540	Clear Heat Seal, peelable heat sealing film, 1 roll (500m x 78mm) <sup>1</sup>
4ti-0540/80	Clear Heat Seal, peelable heat sealing film, 1 roll (80m x 78mm) <sup>1</sup>
4ti-0540/REMP	Clear Heat Seal, peelable heat sealing film, 1 roll (500m x 78mm) <sup>3</sup>
4ti-0540S	Clear Heat Seal, peelable heat sealing film, 1 sample roll (5m x 78mm) <sup>1</sup>
4ti-0542	Clear Heat Seal, peelable heat sealing film, 1 roll (350m x 115mm) <sup>2</sup>
4ti-0542/REMP	Clear Heat Seal, peelable heat sealing film, 1 roll (350m x 115mm) <sup>4</sup>
4ti-0542S	Clear Heat Seal, peelable heat sealing film, 1 sample roll (5m x 115mm) <sup>2</sup>
4ti-0541	Clear Heat Seal, peelable heat sealing film, 100 sheets (125 x 78mm) per case

<sup>1</sup> Compatible with Azenta Semi-Automated Sheet Heat Sealer / Thermo Fisher ALPS 300™ and ALPS 3000™ / KBiosystems Wasp™ / KBioscience FlexiSeal and Cube

<sup>2</sup> Compatible with Agilent (Velocity 11) PlateLoc®.

<sup>3</sup> Compatible with Azenta Portrait Heat Sealer.

<sup>4</sup> Compatible with Azenta Landscape / Stacking Heat Sealers

# Clear Weld Heat Seal

**Optically clear heat sealing film, non-peelable, difficult to pierce; suitable for qPCR, optical applications and storage**

- Heat sealing offers a 100% effective method for plate sealing for a complete seal integrity, as well as being quick and cost effective
- Our Clear Weld Heat Seal is an optically clear polymer film forming a permanent seal to polypropylene plates
- The optical clarity of this seal enables its use for sealing plates required for imaging use, including fluorescent detection methods such as qPCR and colorimetric assays
- The Clear Weld Heat Seal forms a complete seal to a plate, enabling both low and very high temperature uses, including low temperature storage and high temperature incubations
- This seal is suitable for PCR/qPCR, even without the use of a pressurized heated lid, and is 100% effective when used in water bath thermal cyclers
- The permanent nature of this 100% effective seal renders it suitable for the storage and disposal of hazardous material
- Clear Weld Heat Seal demonstrates a good solvent resistance and can be utilized for long term compound storage
- Samples can be accessed by pre-piercing with a blade, needle or our Pierce Plate (4ti-0398)
- This seal is available as sheets, for use with manual and semi-automated sealers such as our Semi-Automated Sheet Heat Sealer
- Also available in multiple roll formats compatible with specified automated heat sealers, such as our Automated Roll Heat Sealer

## Key Features

- Permanent seal
- Difficult to pierce
- Non-peelable
- Seal integrity range: -80°C to 110°C
- DMSO and solvent resistant
- Autoclavable (121°C)\* Once autoclaved, not recommended for PCR applications
- Free from DNase, RNase, human genomic DNA, and endotoxin/pyrogen

## Use

- Applications: suitable for PCR and qPCR, long term storage, and disposal of hazardous materials
- Seals polypropylene plates
- Compatible with water bath thermal cyclers



Seal Integrity  
Temperature Range

-80°C
110°C

\*Once autoclaved, not recommended for PCR



## Options

- Sheet format: 125 x 78 mm, to fit all standard SBS footprint PCR and qPCR plates, microplates, assay and storage plates, from 12 well to 1536 well
- Roll format: available in a variety of roll dimensions, to suit your choice of automatic heat sealing equipment
- Non-gamma treated as standard; gamma treatment available upon request
- Also available with our FrameSeal™ technology, a disposable, rigid, plastic frame perfect for use with a robotic gripper to be used within an automation cell

## Ordering Information

4ti-0573	Clear Weld Heat Seal, optically clear heat sealing film, 1 roll (610m x 78mm) <sup>1</sup>
4ti-0573/122	Clear Weld Heat Seal, optically clear heat sealing film, 1 roll (122m x 78mm) <sup>1</sup>
4ti-0573S	Clear Weld Heat Seal, optically clear heat sealing film, 1 sample roll (5m x 78mm) <sup>1</sup>
4ti-0574	Clear Weld Heat Seal, optically clear heat sealing film, 1 roll (500m x 115mm) <sup>2</sup>
4ti-0574S	Clear Weld Heat Seal, optically clear heat sealing film, 1 sample roll (5m x 115mm) <sup>2</sup>
4ti-0575**	Clear Weld Heat Seal, optically clear heat sealing film, 100 sheets (125 x 78mm) per case

<sup>1</sup> Compatible with Azenta Semi-Automated Sheet Heat Sealer / Thermo Fisher ALPS 300™ and ALPS 3000™ / KBiosystems Wasp™ / KBioscience FlexiSeal and Cube

<sup>2</sup> Compatible with Agilent (Velocity 11) PlateLoc®

\*\* Seals are inter-leaved with paper sheets. This helps to denote which side is the sealing side, plus aids removal of one sheet at a time from the pack

# Clear Heat Seal Plus

**High tensile strength heat sealing film, optically clear, peelable; suitable for bead mill applications**

- Heat sealing offers a 100% effective method for plate sealing for a complete seal integrity, as well as being quick and cost effective
- Our Clear Heat Seal Plus is a clear polymer film forming a peelable seal to polypropylene, polystyrene and cyclic olefin copolymer (COC) plates
- The excellent tensile strength of this seal enables its use for sealing of microplates during homogenisation or disruption of seeds or other material such as bead mill applications
- Clear Heat Seal Plus forms a complete seal to a plate also enabling short term sample storage
- The Clear Heat Seal Plus is thicker than our standard Clear Heat Seal for application requiring high tensile strength, but is not as suitable for optical applications due to decreased transmission through the thicker sealing layers
- For optical applications please refer to our Clear Heat Seal
- This seal is available as sheets, for use with manual and semi-automated sealers such as our Semi-Automated Sheet Heat Sealer
- Also available in multiple roll formats compatible with specified automated heat sealers, such as our Automated Roll Heat Sealer

## Key Features

- Peelable
- Seal integrity range: -80°C to 80°C (110°C with a pressurized heated lid)
- High tensile strength for bead mill applications
- Free from DNase, RNase, human genomic DNA, and endotoxin/pyrogen

## Use

- Applications: suitable for bead mill applications and PCR

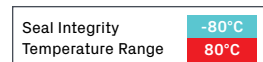

\*110°C with pressurized heated lid



## Options

- Sheet format: 125 x 78 mm, to fit all standard SBS footprint PCR plates, microplates, assay and storage plates, from 12 well to 1536 well
- Roll format: available in two roll dimensions, to suit your choice of automatic heat sealing equipment
- Non-gamma treated as standard; gamma treatment available upon request

## Ordering Information

4ti-0549	Clear Heat Seal Plus, high tensile strength heat sealing film, 1 roll (250m x 78mm) <sup>1</sup>
4ti-0549/S	Clear Heat Seal Plus, high tensile strength heat sealing film, 1 sample roll (5m x 78mm) <sup>1</sup>
4ti-0548	Clear Heat Seal Plus, high tensile strength heat sealing film, 1 roll (250m x 115mm) <sup>2</sup>
4ti-0548/S	Clear Heat Seal Plus, high tensile strength heat sealing film, 1 sample roll (5m x 115mm) <sup>2</sup>
4ti-05481	Clear Heat Seal Plus, high tensile strength heat sealing film, 100 sheets (125 x 78mm) per case

<sup>1</sup> Compatible with Agilent (Velocity 11) PlateLoc®

<sup>2</sup> Compatible with Azenta Semi-Automated Sheet Heat Sealer / Thermo Fisher ALPS 300™ and ALPS 3000™ / KBiosystems Wasp™ / KBioscience FlexiSeal and Cube

# Clear Heat Seal Easily Pierceable

Thin polyester heat sealing film, easily pierceable with autosampler needles/ABI® 3730; suitable for PCR, qPCR and optical applications

- Heat sealing offers a 100% effective method for plate sealing for a complete seal integrity, as well as being quick and cost effective
- Our Clear Heat Seal Easily Pierceable is an optically clear polyester backed film, forming a pierceable seal to polypropylene, polyethylene, polystyrene and cyclic olefin copolymer (COC) plates
- The optical clarity of this seal enables its use for sealing plates required for imaging use, including fluorescent detection methods such as qPCR and colorimetric assays
- Its pierceability renders it useful for automation and for use on needle, capillary and tip based liquid handling systems
- Effective on the ABI® 3730 capillary sequencer, removing the need for the use of expensive septa mats
- The Clear Heat Seal Easily Pierceable forms a complete seal to a plate enabling moderately low and high temperature uses, including PCR when using a pressurized heated lid thermal cycler
- Demonstrates a moderate solvent resistance and can be utilized for short term compound storage
- Also available in multiple roll formats compatible with specified automated heat sealers, such as our Automated Roll Heat Sealer
- A perforated roll is available, for easy removal of sheets, for use with manual and semi-automated sealers

## Key Features

- Permanent seal
- Easily pierceable with autosampler needles/ABI® 3730
- Seal integrity range: -20°C to 80°C (or 110°C when used with pressurized heated PCR lid)
- Moderate solvent resistance
- Optically clear
- Free from DNase, RNase, human genomic DNA, and endotoxin/pyrogen

## Use

- Seals polypropylene, polyethylene, polystyrene and cyclic olefin copolymer (COC) plates
- Suitable for capillary sequencers and automated liquid handlers, e.g. ABI® 3730
- Suitable for PCR and qPCR, and short term storage

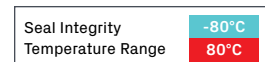

\*110°C with pressurized heated lid



## Options

- Roll format: available in a variety of roll dimensions, to suit your choice of automatic heat sealing equipment
- Sheet format: 125 x 78 mm, available from a roll with 1,000 perforated sheets; seals all SBS plate formats, from 12 well to 1536 well
- Non-gamma treated as standard; gamma treatment available upon request

## Ordering Information

4ti-0580	Clear Heat Seal, easily pierceable with autosampler needles, thin polyester heat sealing film, 1 roll (610m x 78mm) <sup>1</sup>
4ti-0580/122	Clear Heat Seal, easily pierceable with autosampler needles, thin polyester heat sealing film, 1 roll (122m x 78mm) <sup>1</sup>
4ti-0580S	Clear Heat Seal, easily pierceable with autosampler needles, thin polyester heat sealing film, 1 sample roll (5m x 78mm) <sup>1</sup>
4ti-0582	Clear Heat Seal, easily pierceable with autosampler needles, thin polyester heat sealing film, 1 roll (500m x 115mm) <sup>2</sup>
4ti-0582S	Clear Heat Seal, easily pierceable with autosampler needles, thin polyester heat sealing film, 1 sample roll (5m x 115mm) <sup>2</sup>
4ti-0581	Clear Heat Seal, easily pierceable with autosampler needles, thin polyester heat sealing film, 1 perforated roll with sheets (125 x 78mm)

<sup>1</sup> Compatible with Azenta Semi-Automated Sheet Heat Sealer / Thermo Fisher ALPS 300™ and ALPS 3000™ / KBiosystems Wasp™ / KBioscience FlexiSeal and Cube

<sup>2</sup> Compatible with Agilent (Velocity 11) PlateLoc®

# Peel Heat Seal

**Peelable heat sealing foil; suitable for low temperature storage, high temperature uses and PCR**

- Heat sealing offers a 100% effective method of plate sealing, for complete seal integrity, as well as being quick and cost effective
- Our Peel Heat Seal is a laminate seal compatible with polypropylene plates
- It can be removed from polypropylene plates by peeling, even with a plate which has been removed directly from -80°C storage
- Peel Heat Seal forms a complete seal to a plate enabling very low temperature uses, including very low temperature storage, and high temperature uses, such as PCR (when used with a pressurized heated lid)
- The seal demonstrates moderate solvent resistance and can be utilized for short term compound storage at room temperature
- This seal is available as sheets, for use with manual and semi-automated sealers such as our Semi-Automated Sheet Heat Sealer
- Also available in multiple roll formats compatible with specified automated heat sealers, such as our Automated Roll Heat Sealer

## Key Features

- Peelable from polypropylene and COC plates
- Seal integrity range: -80°C to 90°C (110°C when used with pressurized heated lid)
- Good solvent resistance including DMSO
- Autoclavable (121°C)
- Free from DNase, RNase, human genomic DNA, and endotoxin/pyrogen

## Use

- Suitable for short term room temperature storage
- Suitable for very low temperature storage

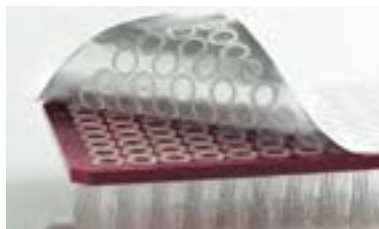

Seal Integrity Temperature Range	-80°C 90°C
----------------------------------	---------------

\*110°C with pressurized heated lid

Peelable	Autoclavable

## Options

- Sheet format: 125 x 78 mm, to fit all standard SBS footprint PCR and qPCR plates, microplates, assay and storage plates, from 12 well to 1536 well
- Roll format: available in a variety of roll dimensions, to suit your choice of automatic heat sealing equipment
- Non-gamma treated as standard; gamma treatment available upon request

## Ordering Information

<b>4ti-0520</b>	<b>Peel Heat Seal, peelable heat sealing foil, 1 roll (610m x 78mm)<sup>1</sup></b>
<b>4ti-0520/122</b>	<b>Peel Heat Seal, peelable heat sealing foil, 1 roll (122m x 78mm)<sup>1</sup></b>
<b>4ti-0520S</b>	<b>Peel Heat Seal, peelable heat sealing foil, 1 sample roll (5m x 78mm)<sup>1</sup></b>
<b>4ti-0522</b>	<b>Peel Heat Seal, peelable heat sealing foil, 1 roll (500m x 115mm)<sup>2</sup></b>
<b>4ti-0522S</b>	<b>Peel Heat Seal, peelable heat sealing foil, 1 sample roll (5m x 115mm)<sup>2</sup></b>
<b>4ti-0521</b>	<b>Peel Heat Seal, peelable heat sealing foil, 100 sheets (125 x 78mm) per case</b>

<sup>1</sup> Compatible with Azenta Semi-Automated Sheet Heat Sealer / Thermo Fisher ALPS 300™ and ALPS 3000™ / KBiosystems Wasp™ / KBioscience FlexiSeal and Cube

<sup>2</sup> Compatible with Agilent (Velocity 11) PlateLoc®

# Universal Peel Heat Seal

**Peelable heat sealing foil with wide material compatibility; suitable for low temperature storage, high temperature uses and PCR**

- Heat sealing offers a 100% effective method of plate sealing, for complete seal integrity, as well as being quick and cost effective
- Our Universal Peel Heat Seal is a laminate seal compatible with PP, PE, PS, COC and PC plates, providing the highest flexibility in plate material choice
- Sample access is possible by peeling from the compatible materials and also by piercing the seal with needles, but not with plastic tips
- It is resealable by applying another Universal Peel Heat Seal directly on top of a previously pierced seal
- Universal Peel Heat Seal forms a complete seal to a plate enabling low temperature uses as well as high temperature uses, such as PCR (when used with a pressurized heated lid)
- The seal demonstrates moderate solvent resistance
- Use of Universal Peel Heat Seal makes roll changes unnecessary even for customers using different microplate materials, because with minor adjustments of sealing parameters all common microplate materials can be sealed to
- This seal is available as sheets, for use with manual and semi-automated sealers such as our Semi-Automated Sheet Heat Sealer
- Also available in multiple roll formats compatible with specified automated heat sealers, such as our Automated Roll Heat Sealer

## Key Features

- Pierceable with needle, but not with standard pipette tips
- Peelable
- Seal integrity temperature range: -80°C to 90°C (110°C when used with a pressurized heated lid)
- Autoclavable (121°C)
- Free from DNase, RNase, human genomic DNA, and endotoxin/pyrogen

## Use

- Suitable for low temperature sample storage and high temperature uses, such as PCR
- Compatible with PP, PE, PS, COC and PC plates
- Wide material compatibility allows for high throughput sealing of different plates without the need for roll changes
- Resealable by applying another Universal Peel Heat Seal directly on top of a previously pierced seal



Seal Integrity Temperature Range	-80°C 90°C
----------------------------------	---------------

\*110°C with pressurized heated lid

Peelable	Autoclavable

## Options

- Sheet format: 125 mm x 78 mm, to fit all standard SBS footprint PCR and qPCR plates, microplates, assay and storage plates, from 12 well to 1536 well
- Roll format: available in two roll dimensions, to suit your choice of automatic heat sealing equipment

## Ordering Information

<b>4ti-0523</b>	Universal Peel Heat Seal, peelable heat sealing foil with wide material compatibility, 1 roll (610m x 78mm) <sup>1</sup>
<b>4ti-0523S</b>	Universal Peel Heat Seal, peelable heat sealing foil with wide material compatibility, 1 sample roll (5m x 78mm) <sup>1</sup>
<b>4ti-0524</b>	Universal Peel Heat Seal, peelable heat sealing foil with wide material compatibility, 1 roll (500m x 115mm) <sup>2</sup>
<b>4ti-0524S</b>	Universal Peel Heat Seal, peelable heat sealing foil with wide material compatibility, 1 sample roll (5m x 115mm) <sup>2</sup>
<b>4ti-05231</b>	Universal Peel Heat Seal, peelable heat sealing foil with wide material compatibility, 100 sheets (125 x 78mm) per case

<sup>1</sup> Compatible with Azenta Semi-Automated Sheet Heat Sealer / Thermo Fisher ALPS 300™ and ALPS 3000™ / KBiosystems Wasp™ / KBioscience FlexiSeal and Cube

<sup>2</sup> Compatible with Agilent (Velocity 11) PlateLoc®

# Individual Access Peel Heat Seal

**Peelable heat sealing foil, 96 individual seals with tabs, or 12 strips each covering 8 wells; suitable for very low temperature storage/high temperature uses/PCR**

- Heat sealing offers a 100% effective method of plate sealing, for complete seal integrity, as well as being quick and cost effective
- Our Individual Access Peel Heat Seal is a laminate seal compatible with polypropylene plates, featuring 96 individual foil seal spots or 12 strips of individual spots on a removable backing
- These seals result in individually sealed tubes/strips, and they can be removed from polypropylene plates by peeling, even with a plate which has been removed directly from -80°C storage
- Individual Access Peel Heat Seal forms a complete seal to a plate enabling very low temperature uses, including very low temperature storage, and high temperature uses, such as PCR (when used with a pressurized heated lid)
- The seal demonstrates moderate solvent resistance and can be utilized for short term compound storage at room temperature
- This seal is available as sheets, for use with manual and semi-automated sealers, such as our Semi-Automated Sheet Heat Sealer (using the 4ti-0613 Individual Access adapter)

## Key Features

- 96 individual foil seal spots or 12 strips of 8 spots on a removable backing
- 4 pin holes for exact positioning in special adapters of the Semi-Automated Sheet Heat Sealer
- Peelable from polypropylene and COC plates
- Seal integrity range: -80°C to 90°C (110°C when used with pressurized heated lid)
- Good solvent resistance including DMSO
- Autoclavable (121°C)
- Free from DNase, RNase, human genomic DNA, and endotoxin/pyrogen

## Use

- Suitable for short term room temperature storage
- Suitable for very low temperature storage
- Best used in combination with our Individual Access plates and Breakable Vertically PCR Plates



Seal Integrity Temperature Range	-80°C 90°C
----------------------------------	---------------

\*110°C with pressurized heated lid

Peelable	Autoclavable

## Options

- Available as 96 individual seals with tabs per sheet
- Also available as 12 strips of 8 individual seals per sheet
- Sheet format: 127 x 100 mm
- Non-gamma treated as standard; gamma treatment available upon request

## Ordering Information

<b>4ti-0521/RA-TAB</b>	<b>Individual Access Peel Heat Seal, with tabs, peelable heat sealing foil, 96 individual seals with tabs, sheet format, 100 sheets (127 x 100mm) per case</b>
<b>4ti-0521/RA-8</b>	<b>Individual Access Peel Heat Seal, peelable heat sealing foil, 12 strips, each covering 8 wells, sheet format, 100 sheets (127 x 100mm) per case</b>



**AZENTA**  
LIFE SCIENCES

# DMSO Resistant Peel Heat Seal

## Solvent resistant heat sealing foil, peelable; suitable for low and room temperature compound storage

- Our DMSO Resistant Peel Heat Seal is a foil seal compatible with polypropylene and forming an excellent seal to cyclic olefin copolymer (COC) plates
- The solvent resistance of this seal enables its use for low and room temperature compound storage in Dimethyl Sulfoxide (DMSO) and organic solvents
- 100% DMSO can be stored at room temperature for 12 months without deterioration of the seal
- It forms a weld seal to polyethylene plates and cannot be peeled off
- Access is by piercing using a blade, needle, or an Azenta Pierce Plate (4ti-0398)
- This seal is available as sheets, for use with manual and semi-automated sealers such as our Semi-Automated Sheet Heat Sealer
- Also available in multiple roll formats compatible with specified automated heat sealers, such as our Automated Roll Heat Sealer
- The sheet seals are inter-leaved with paper sheets to help denote which side is the sealing side and to aid removal of one sheet at a time from the pack

## Key Features

- Permanent seal to polyethylene
- Peelable seal to polypropylene and COC
- Seal integrity range: -80°C to 40°C
- High solvent resistance, including 100% DMSO
- Free from DNase, RNase, human genomic DNA, and endotoxin/pyrogen

## Use

- Suitable for long term storage



## Options

- Sheet format: 125 x 78 mm, to fit all standard SBS footprint PCR and qPCR plates, microplates, assay and storage plates, from 12 well to 1536 well
- Roll format: available in a variety of roll dimensions, to suit your choice of automatic heat sealing equipment
- Non-gamma treated as standard; gamma treatment available upon request

## Ordering Information

<b>4ti-0585</b>	DMSO Resistant Peel Heat Seal, solvent resistant heat sealing foil, 1 roll (500m x 78mm) <sup>1</sup>
<b>4ti-0585/100</b>	DMSO Resistant Peel Heat Seal, solvent resistant heat sealing foil, 1 roll (100m x 78mm) <sup>1</sup>
<b>4ti-0585/REMP</b>	DMSO Resistant Peel Heat Seal, solvent resistant heat sealing foil, 1 roll (500m x 78mm) <sup>3</sup>
<b>4ti-0585S</b>	DMSO Resistant Peel Heat Seal, solvent resistant heat sealing foil, 1 sample roll (5m x 78mm) <sup>1</sup>
<b>4ti-0586</b>	DMSO Resistant Peel Heat Seal, solvent resistant heat sealing foil, 1 roll (500m x 115mm) <sup>2</sup>
<b>4ti-0586/REMP</b>	DMSO Resistant Peel Heat Seal, solvent resistant heat sealing foil, 1 roll (500m x 115mm) <sup>4</sup>
<b>4ti-0586S</b>	DMSO Resistant Peel Heat Seal, solvent resistant heat sealing foil, 1 sample roll (5m x 115mm) <sup>2</sup>
<b>4ti-0587</b>	DMSO Resistant Peel Heat Seal, solvent resistant heat sealing foil, 1 perforated roll with 100 sheets (125 x 78mm)

<sup>1</sup> Compatible with Azenta Semi-Automated Sheet Heat Sealer / Thermo Fisher ALPS 300™ and ALPS 3000™ / KBiosystems Wasp™ / KBioscience FlexiSeal and Cube

<sup>2</sup> Compatible with Agilent (Velocity 11) PlateLoc®

<sup>3</sup> Compatible with Azenta Portrait Heat Sealer

<sup>4</sup> Compatible with Azenta Landscape / Stacking Heat Sealers



# Pierce Heat Seal

**Pierceable heat sealing foil, high solvent resistance, resealable, suitable for PCR/storage/shipping**

- Heat sealing offers a 100% effective method of plate sealing, for complete seal integrity, as well as being quick and cost effective
- Pierce Heat Seal is compatible with polypropylene and polystyrene plates
- This seal demonstrates good solvent resistance and can be used for low temperature and room temperature compound storage in DMSO and organic solvents
- Pierce Heat Seal can be pierced with a pipette tip manually, or by a liquid handling robot
- This seal can be resealed by applying another Pierce Seal straight on top of a previously pierced seal
- This seal is available as sheets, for use with manual and semi-automated sealers such as our Semi-Automated Sheet Heat Sealer
- Also available in multiple roll formats compatible with specified automated heat sealers, such as our Automated Roll Heat Sealer
- A blue stripe on the sheet foils clearly indicates the non-sealing surface, for ease of seal orientation and handling
- Pierce Heat Seal sheets are also available with a printed grid reference on the non-sealing surface

## Key Features

- Pierceable
- Resealable
- Seal integrity range: -20°C to 120°C
- Good solvent resistance
- Autoclavable (121°C)
- Free from DNase, RNase, human genomic DNA, and endotoxin/pyrogen

## Use

- Seals polypropylene and polystyrene plates
- Suitable for long term storage

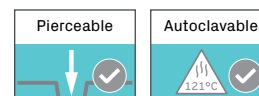
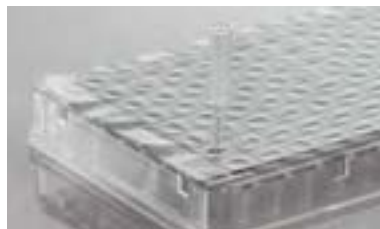

## Options

- Sheet format: 125 x 78 mm, to fit all standard SBS footprint PCR and qPCR plates, microplates, assay and storage plates, from 12 well to 1536 well
- Roll format: available in a variety of roll dimensions, to suit your choice of automatic heat sealing equipment
- Available with printed grid reference (in sheet format, 4ti-0531/GR)
- Non-gamma treated as standard; gamma treatment available upon request
- Custom printing available on request

## Ordering Information

<b>4ti-0530</b>	Pierce Heat Seal, pierceable heat sealing foil, 1 roll (610m x 78mm) <sup>1</sup>
<b>4ti-0530/122</b>	Pierce Heat Seal, pierceable heat sealing foil, 1 roll (122m x 78mm) <sup>1</sup>
<b>4ti-0530/REMP</b>	Pierce Heat Seal, pierceable heat sealing foil, 1 roll (610m x 78mm) <sup>3</sup>
<b>4ti-0530S</b>	Pierce Heat Seal, pierceable heat sealing foil, 1 sample roll (5m x 78mm) <sup>1</sup>
<b>4ti-0532</b>	Pierce Heat Seal, pierceable heat sealing foil, 1 roll (500m x 115mm) <sup>2</sup>
<b>4ti-0532/REMP</b>	Pierce Heat Seal, pierceable heat sealing foil, 1 roll (500m x 115mm) <sup>4</sup>
<b>4ti-0532S</b>	Pierce Heat Seal; pierceable heat sealing foil, 1 sample roll (5m x 115mm) <sup>2</sup>
<b>4ti-0531</b>	Pierce Heat Seal, pierceable heat sealing foil, 100 sheets (125 x 78mm) per case
<b>4ti-0531/GR</b>	Pierce Heat Seal, with Grid Reference, pierceable heat sealing foil, 100 sheets (125 x 78mm) per case

<sup>1</sup> Compatible with Azenta Semi-Automated Sheet Heat Sealer / Thermo Fisher ALPS 300™ and ALPS 3000™ / KBiosystems Wasp™ / KBioscience FlexiSeal and Cube

<sup>2</sup> Compatible with Agilent (Velocity 11) PlateLoc®

<sup>3</sup> Compatible with Azenta Portrait Heat Sealer

<sup>4</sup> Compatible with Azenta Landscape / Stacking Heat Sealers

# Individual Access Pierce Heat Seal

**Pierceable heat sealing foil, 96 individual seals in sheet format, high solvent resistance, resealable; suitable for PCR/storage/shipping**

- Heat sealing offers a 100% effective method of plate sealing, for complete seal integrity, as well as being quick and cost effective
- Individual Access Pierce Heat Seal is compatible with polypropylene and polystyrene plates, featuring 96 individual foil seal spots on a removable backing
- This seal demonstrates good solvent resistance and can be used for low temperature and room temperature compound storage in DMSO and organic solvents
- These seals result in individually sealed tubes, and they can be pierced with a pipette tip manually, or by a liquid handling robot
- Individual Access Pierce Heat Seal can be resealed by applying another Individual Access Pierce Seal straight on top of a previously pierced seal
- This seal is available as sheets, for use with manual and semi-automated sealers such as our Semi-Automated Sheet Heat Sealer

## Key Features

- 96 individual foil seal spots on a removable backing
- Pierceable
- 4 pin holes for exact positioning in special adapters of the Semi-Automated Sheet Heat Sealer
- Resealable
- Seal integrity range: -20°C to 120°C
- Good solvent resistance
- Autoclavable (121°C)
- Free from DNase, RNase, human genomic DNA, and endotoxin/pyrogen

## Use

- Seals polypropylene and polystyrene plates
- Suitable for long term storage
- Best used in combination with our Individual Access plates



Seal Integrity Temperature Range  
-20°C  
120°C

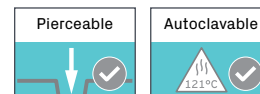

## Options

- Sheet format: 127 x 100 mm, to fit all standard SBS footprint PCR and qPCR plates, microplates, assay and storage plates
- Non-gamma treated as standard; gamma treatment available upon request

## Ordering Information

4ti-0531/RA

Individual Access Pierce Heat Seal, pierceable heat sealing foil, 96 individual seals in sheet format, 100 sheets (127 x 100mm) per case

# Pierce Heat Seal Strong

**Strong heat sealing foil, peelable from COC plates, pierceable, suitable for PCR, sample shipping, compound storage**

- Heat sealing offers a 100% effective method of plate sealing, for complete seal integrity, as well as being quick and cost effective
- Pierce Heat Seal Strong is compatible with polypropylene and COC plates
- This seal is peelable from COC plates and gives a weld seal to polypropylene plates
- Demonstrating good solvent resistance it can be used for low temperature and room temperature compound storage in DMSO and organic solvents
- The seal can be pierced with a pipette tip manually, or by a liquid handling robot
- Applications include PCR, sample shipping, low and room temperature compound storage with DMSO and other organic solvents
- This seal is available as sheets, for use with manual and semi-automated sealers such as our Semi-Automated Sheet Heat Sealer
- Also available in multiple roll formats compatible with specified automated heat sealers, such as our Automated Roll Heat Sealer

## Key Features

- Pierceable
- Peelable from COC plates
- Seal integrity range: -20°C to 120°C
- Good solvent resistance
- Gives a weld seal to polypropylene plates
- Free from DNase, RNase, human genomic DNA, and endotoxin/pyrogen

## Use

- Seals polypropylene and COC plates
- Recommended for PCR, sample shipping, low and room temperature compound storage with DMSO and other organic solvents
- Suitable for long term storage



## Options

- Sheet format: 125 x 78 mm, to fit all standard SBS footprint PCR and qPCR plates, microplates, assay and storage plates, from 12 well to 1536 well
- Roll format: available in two roll dimensions: 610 m x 78 mm, and 500 m x 115 mm
- Custom printing available upon request
- Non-gamma treated as standard; gamma treatment available upon request

## Ordering Information

<b>4ti-0538</b>	<b>Pierce Heat Seal Strong, strong heat sealing foil, 1 roll (610m x 78mm)<sup>1</sup></b>
<b>4ti-0538S</b>	<b>Pierce Heat Seal Strong, strong heat sealing foil, 1 sample roll (5m x 78mm)<sup>1</sup></b>
<b>4ti-0539</b>	<b>Pierce Heat Seal Strong, strong heat sealing foil, 1 roll (500m x 115mm)<sup>2</sup></b>
<b>4ti-0539S</b>	<b>Pierce Heat Seal Strong, strong heat sealing foil, 1 sample roll (5m x 115mm)<sup>2</sup></b>
<b>4ti-05381</b>	<b>Pierce Heat Seal Strong, strong heat sealing foil, 100 sheets (125 x 78mm) per case</b>

<sup>1</sup> Compatible with Azenta Semi-Automated Sheet Heat Sealer / Thermo Fisher ALPS 300™ and ALPS 3000™ / KBiosystems Wasp™ / KBioscience FlexiSeal and Cube

<sup>2</sup> Compatible with Agilent (Velocity T1) PlateLoc®



# Individual Access Pierce Heat Seal Strong

## Sheets of 96 foil seal spots for sealing of individual wells, suitable for storage and PCR, pierceable

- Individual Access Pierce Heat Seal Strong features 96 individual foil seal spots on a removable backing
- These seals result in individually sealed tubes that are pierceable, allowing for sample addition straight into pre-dispensed reagents, without fiddly removal of the seal
- Individual Access Pierce Heat Seal Strong is compatible with polypropylene and COC plates
- This seal is peelable from COC plates and gives a weld seal to polypropylene plates
- Demonstrating good solvent resistance, it can be used for low temperature and room temperature compound storage in DMSO and organic solvents
- The seal can be pierced with a pipette tip manually, or by a liquid handling robot
- Applications include sample shipping, storage and PCR
- This seal is available as sheets, for use with manual and semi-automated sealers, such as our Semi-Automated Sheet Heat Sealer (using the 4ti-0613 Individual Access adapter)
- The 96 well Individual Access plate can be sealed in one step resulting in individually sealed tubes that are pierceable, allowing for sample access

## Key Features

- 96 individual foil seal spots on a removable backing
- 4 pin holes for exact positioning in special adapters of the Semi-Automated Sheet Heat Sealer
- Seals polypropylene (weld seal) and COC (peelable seal) plates
- Pierceable
- Seal integrity range: -20°C to 120°C
- Good solvent resistance
- Free from DNase, RNase, human genomic DNA, and endotoxin/pyrogen

## Use

- Recommended for PCR, sample shipping, low and room temperature compound storage with DMSO and other organic solvents
- Best used in combination with our Individual Access 96 Well Skirted PCR Plate (4ti-0960/RA)



## Options

- Sheet format: 127 mm x 100 mm

## Ordering Information

4ti-05381/RA	Individual Access Pierce Heat Seal Strong, strong heat sealing foil, 96 individual seals in sheet format, 100 sheets (127 x 100mm) per case
4ti-0539/RA	Individual Access Pierce Heat Seal Strong, strong heat sealing foil, 96 individual seals in roll format, 1 roll (420m x 100mm)

# Foil Heat Seal

**Aluminium heat sealing foil, resealable, peelable, pierceable; suitable for compound storage, PCR**

- Our Foil Heat Seal is compatible with polypropylene and polystyrene plates
- This seal demonstrates moderate solvent resistance and can be used for low temperature compound storage in DMSO and organic solvents and short term room temperature storage
- The Foil Heat Seal can be pierced with a pipette tip, manually or by liquid handling robots, or it can be removed by peeling
- It can be resealed by applying another Foil Heat Seal directly on top of a previously pierced seal
- This seal is available as sheets, for use with manual and semi-automated sealers such as our Semi-Automated Sheet Heat Sealer
- Also available in multiple roll formats compatible with specified automated heat sealers, such as our Automated Roll Heat Sealer
- A red stripe on the sheet foils clearly indicates the non-sealing surface, for ease of seal orientation and handling

## Key Features

- Pierceable
- Peelable
- Resealable
- Seal integrity range: -20°C to 110°C
- Moderate solvent resistance
- Autoclavable (121°C)
- Free from DNase, RNase, human genomic DNA, and endotoxin/pyrogen

## Use

- Seals polypropylene and polystyrene plates
- Suitable for short term storage

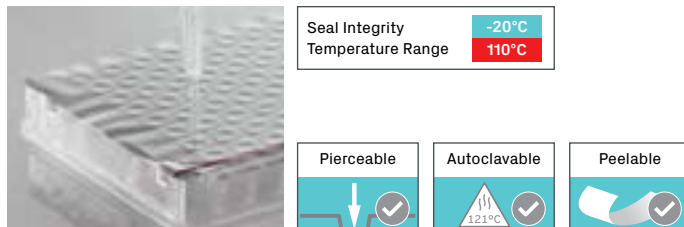

## Options

- Sheet format: 125 x 78 mm, to fit all standard SBS footprint PCR and qPCR plates, microplates, assay and storage plates, from 12 well to 1536 well
- Roll format: available in a variety of roll dimensions, to suit your choice of automatic heat sealing equipment
- Non-gamma treated as standard; gamma treatment available upon request

## Ordering Information

<b>4ti-0535</b>	Foil Heat Seal, aluminium heat sealing foil, 1 roll (610m x 78mm) <sup>1</sup>
<b>4ti-0535/122</b>	Foil Heat Seal, aluminium heat sealing foil, 1 roll (122m x 78mm) <sup>1</sup>
<b>4ti-0535/REMP</b>	Foil Heat Seal, aluminium heat sealing foil, 1 roll (610m x 78mm) <sup>3</sup>
<b>4ti-0535S</b>	Foil Heat Seal, aluminium heat sealing foil, 1 sample roll (5m x 78mm) <sup>1</sup>
<b>4ti-0537</b>	Foil Heat Seal, aluminium heat sealing foil, 1 roll (500m x 115mm) <sup>2</sup>
<b>4ti-0537/REMP</b>	Foil Heat Seal, aluminium heat sealing foil, 1 roll (500m x 115mm) <sup>4</sup>
<b>4ti-0537S</b>	Foil Heat Seal, aluminium heat sealing foil, 1 sample roll (5m x 115mm) <sup>2</sup>
<b>4ti-0536</b>	Foil Heat Seal, aluminium heat sealing foil, 100 sheets (125 x 78mm) per case

<sup>1</sup> Compatible with Azenta Semi-Automated Sheet Heat Sealer / Thermo Fisher ALPS 300™ and ALPS 3000™ / KBiosystems Wasp™ / KBioscience FlexiSeal and Cube

<sup>2</sup> Compatible with Agilent (Velocity 11) PlateLoc®

<sup>3</sup> Compatible with Azenta Portrait Heat Sealer

<sup>4</sup> Compatible with Azenta Landscape | Stacking Heat Sealers



# Polystyrene Foil Heat Seal

**Peelable heat sealing foil, seals to polystyrene plates, resealable, pierceable; suitable for compound storage**

- Heat sealing offers a 100% effective method of plate sealing, for complete seal integrity, as well as being quick and cost effective
- Our Polystyrene Foil Heat Seal produces a stronger seal to polystyrene plates than our standard Foil Heat Seal
- Compatible with polypropylene, polystyrene and polycarbonate plates
- This seal demonstrates moderate solvent resistance and can be used for low temperature compound storage, in DMSO and organic solvents, and short term room temperature storage
- Polystyrene Foil Heat Seal can be pierced with a pipette tip manually, by a liquid handling robot, using the Azenta Pierce Plate (4ti-0398), or it can be removed by peeling. It can be resealed by applying another Polystyrene Foil Heat Seal directly on top of a previously pierced seal
- This seal is available as sheets, for use with manual and semi-automated sealers such as our Semi-Automated Sheet Heat Sealer
- Also available in multiple roll formats compatible with specified automated heat sealers, such as our Automated Roll Heat Sealer

## Key Features

- Pierceable
- Peelable
- Resealable foil on foil
- Seal integrity range: -20°C to 110°C
- Free from DNase, RNase, human genomic DNA, and endotoxin/pyrogen

## Use

- Seals polypropylene, polystyrene and polycarbonate plates
- Suitable for short term storage
- Suitable for low temperature compound storage



## Options

- Sheet format: 125 x 78 mm, to fit all standard SBS footprint PCR and qPCR plates, microplates, assay and storage plates, from 12 well to 1536 well
- Roll format: available in a variety of roll dimensions, to suit your choice of automatic heat sealing equipment
- Non-gamma treated as standard; gamma treatment available upon request

## Ordering Information

4ti-0545	Polystyrene Foil Heat Seal, peelable heat sealing foil, 1 roll (610m x 78mm) <sup>1</sup>
4ti-0545/122	Polystyrene Foil Heat Seal, peelable heat sealing foil, 1 roll (122m x 78mm) <sup>1</sup>
4ti-0545S	Polystyrene Foil Heat Seal, peelable heat sealing foil, 1 sample roll (5m x 78mm)
4ti-0546	Polystyrene Foil Heat Seal, peelable heat sealing foil, 1 roll (500m x 115mm) <sup>2</sup>
4ti-0547	Polystyrene Foil Heat Seal, peelable heat sealing foil, 100 sheets (125 x 78mm) per case

<sup>1</sup> Compatible with Azenta Semi-Automated Sheet Heat Sealer / Thermo Fisher ALPS 300™ and ALPS 3000™ / KBiosystems Wasp™ / KBioscience FlexiSeal and Cube

<sup>2</sup> Compatible with Agilent (Velocity 11) PlateLoc®

# Thermal Bond Heat Seal

## Heavy duty heat sealing foil, peelable; suitable for long term storage, transportation

- Heat sealing offers a 100% effective method of plate sealing, for complete seal integrity, as well as being quick and cost effective
- Our Thermal Bond Heat Seal is a heavy duty laminate foil seal suitable for providing a very strong, but peelable seal
- Compatible with polypropylene plates to provide a high degree of sample protection
- Demonstrates very good solvent resistance and can be used for very low temperature compound storage, in DMSO and organic solvents, and long term room temperature storage such that it is recommended as suitable for sample transportation
- The seal can be pierced only by using a blade or using the Azenta Pierce Plate (4ti-0398)
- This seal is available as sheets, for use with manual and semi-automated sealers such as our Semi-Automated Sheet Heat Sealer
- Also available in multiple roll formats compatible with specified automated heat sealers, such as our Automated Roll Heat Sealer

## Key Features

- Peelable
- Seal integrity range: -200°C to 110°C
- High solvent resistance
- Autoclavable (121°C)
- Free from DNase, RNase, human genomic DNA, and endotoxin/pyrogen

## Use

- Recommended for PCR, including with water bath thermal cyclers
- Seals polypropylene plates
- Suitable for long term storage and transportation
- Suitable for very low temperature storage



## Options

- Sheet format: 125 x 78 mm, to fit all standard SBS footprint PCR and qPCR plates, microplates, assay and storage plates, from 12 well to 1536 well
- Roll format: available in a variety of roll dimensions, to suit your choice of automatic heat sealing equipment
- Non-gamma treated as standard; gamma treatment available upon request

## Ordering Information

4ti-0590	Thermal Bond Heat Seal, heavy duty heat sealing foil, 1 roll (500m x 78mm) <sup>1</sup>
4ti-0590/100	Thermal Bond Heat Seal, heavy duty heat sealing foil, 1 roll (100m x 78mm) <sup>1</sup>
4ti-0590S	Thermal Bond Heat Seal, heavy duty heat sealing foil, 1 sample roll (5m x 78mm) <sup>1</sup>
4ti-0592	Thermal Bond Heat Seal, heavy duty heat sealing foil, 1 roll (300m x 115mm) <sup>2</sup>
4ti-0592S	Thermal Bond Heat Seal, heavy duty heat sealing foil, 1 sample roll (5m x 115mm) <sup>2</sup>
4ti-0591	Thermal Bond Heat Seal, heavy duty heat sealing foil, 100 sheets (125 x 78mm) per case

<sup>1</sup> Compatible with Azenta Semi-Automated Sheet Heat Sealer / Thermo Fisher ALPS 300™ and ALPS 3000™ / KBiosystems Wasp™ / KBioscience FlexiSeal and Cube

<sup>2</sup> Not compatible with Agilent (Velocity 11) PlateLoc®

# Gas Permeable Heat Seal

**Heat sealing membrane, limits evaporation, peelable, pierceable; suitable for cell culture, seed and insect storage**

- Heat sealing offers a 100% effective method for plate sealing for a complete seal integrity, as well as being quick and cost effective
- Our Gas Permeable Heat Seal is made from a woven material and is designed for use in cell culture, due to its porous nature
- The small pore size (<20 µm) of this material enables gas exchange, per 24 hours of >20 g/m<sup>2</sup>, whilst evaporation is reduced to a minimum
- Compatible with polypropylene, polystyrene and cyclic olefin copolymer (COC) plates
- It can be removed by peeling, or it can be pierced with a pipette tip manually, using a liquid handling robot or with our Pierce Plate (4ti-0398)
- Gas Permeable Heat Seal can be utilized for effective overnight incubations, during which it demonstrates significant reductions in evaporation compared to lids
- It can also be used for insect and seed storage as it enables gas exchange, whilst providing an inert surface with no adhesive to interfere with the well contents
- This seal is available as sheets, for use with manual and semi-automated sealers such as our Semi-Automated Sheet Heat Sealer
- Also available in multiple roll formats compatible with specified automated heat sealers, such as our Automated Roll Heat Sealer

## Key Features

- Peelable
- Pierceable
- Seal integrity range: -20°C to 80°C
- Gas permeability rate: 180 m<sup>3</sup>/m<sup>2</sup>/day
- Moisture vapor transmission rate: 20 g/m<sup>2</sup>/day
- Autoclavable (121°C)
- Free from DNase, RNase, human genomic DNA, and endotoxin/pyrogen

## Use

- Seals polypropylene, polystyrene and cyclic olefin copolymer (COC) plates
- Suitable for cell culture, overnight incubations, as well as insect and seed storage



Seal Integrity  
Temperature Range  
-20°C  
80°C

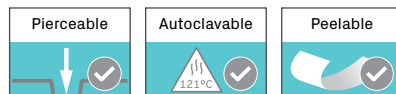

## Options

- Sheet format: 125 x 78 mm, to fit all standard SBS footprint PCR and qPCR plates, microplates, assay and storage plates, from 12 well to 1536 well
- Roll format: available in a variety of roll dimensions, to suit your choice of automatic heat sealing equipment
- Available gamma treated from stock: gamma treated variations have /ST added to the end of their product code

## Ordering Information

<b>4ti-0598</b>	<b>Gas Permeable Heat Seal, heat sealing membrane, 1 roll (610m x 78mm)<sup>1</sup></b>
<b>4ti-0598/122</b>	<b>Gas Permeable Heat Seal, heat sealing membrane, 1 roll (122m x 78mm)<sup>1</sup></b>
<b>4ti-0598S</b>	<b>Gas Permeable Heat Seal, heat sealing membrane, 1 sample roll (5m x 78mm)<sup>1</sup></b>
<b>4ti-0599</b>	<b>Gas Permeable Heat Seal, heat sealing membrane, 1 roll (500m x 115mm)<sup>2</sup></b>
<b>4ti-0599S</b>	<b>Gas Permeable Heat Seal, heat sealing membrane, 1 sample roll (5m x 115mm)<sup>2</sup></b>
<b>4ti-0597</b>	<b>Gas Permeable Heat Seal, heat sealing membrane, 100 sheets (125 x 78mm) per case</b>
<b>4ti-0597/ST</b>	<b>Gas Permeable Heat Seal, Gamma treated, heat sealing membrane, 10 x 10 sheets (125 x 78mm) per case</b>

<sup>1</sup> Compatible with Azenta Semi-Automated Sheet Heat Sealer / Thermo Fisher ALPS 300™ and ALPS 3000™ / KBiosystems Wasp™ / KBioscience FlexiSeal and Cube

<sup>2</sup> Compatible with Agilent (Velocity 11) PlateLoc®



# Clear Heat Seal, Peelable Film

**Peelable heat sealing film, optically clear, with 3mm slits for gas transfer; suitable for insect studies, seed storage**

- Heat sealing is a quick and cost effective method of plate sealing
- Our Clear Heat Seal, Peelable Film is based on our Clear Heat Seal, with the addition of 3mm slits across the width of the seal
- These slits render the seal gas permeable, whilst retaining evaporation to a minimum, compared to the use of lids
- The Clear Heat Seal, Peelable Film is compatible with polypropylene, polyethylene, polystyrene and cyclic olefin copolymer (COC) plates
- The seal can be removed by peeling, or it can be pierced with a pipette tip manually, using a liquid handling robot or with our Pierce Plate (4ti-0398)
- The Clear Heat Seal, Peelable Film has a wider seal integrity temperature range, from -80°C to 110°C, than our Gas Permeable Heat Seal
- It can be used for insect and seed storage, as it enables gas exchange, whilst providing an inert surface with no adhesive to interfere with the well contents
- This seal is available as sheets, for use with manual and semi-automated sealers such as our Semi-Automated Sheet Heat Sealer
- Also available in multiple roll formats compatible with specified automated heat sealers, such as our Automated Roll Heat Sealer

## Key Features

- Peelable
- Seal integrity range: -80°C to 110°C
- 3mm slits for gas transfer
- Free from DNase, RNase, human genomic DNA, and endotoxin/pyrogen

## Use

- Seals polypropylene, polyethylene, polystyrene and cyclic olefin copolymer (COC) plates
- Suitable for insect and seed storage



## Options

- Sheet format: 125 x 78mm, to fit all standard SBS footprint PCR and qPCR plates, microplates, assay and storage plates, from 12 well to 1536 well
- Roll format: 500m x 78mm; approx. 4,200 seals
- Non-gamma treated as standard; gamma treatment available upon request

## Ordering Information

<b>4ti-0540/SLIT</b>	Clear Heat Seal, gas permeable, clear heat sealing film, with 3mm slits for gas transfer, 1 roll (450m x 78mm) <sup>1</sup>
<b>4ti-0540/SLIT/S</b>	Clear Heat Seal, gas permeable, clear heat sealing film, with 3mm slits for gas transfer, 1 sample roll (5m x 78mm)
<b>4ti-0541/SLIT</b>	Clear Heat Seal, gas permeable, clear heat sealing film, with 3mm slits for gas transfer, 100 sheets (125 x 78mm) per case

<sup>1</sup> Compatible with Azena Semi-Automated Sheet Heat Sealer / Thermo Fisher ALPS 300™ and ALPS 3000™ / KBiosystems Wasp™ / KBioscience FlexiSeal and Cube



# Thermal Individual Tube Seal, 96-Format

Thermal Individual Tube Seal was designed for the heat sealing of 96 well microplates or 96 format cluster tubes, preserving sample integrity and audit trail in compound library and other high-throughput applications

- 96 individual sealing spots on a backing liner
- Creates an air-tight seal
- Peelable and pierceable
- “Embossed” seal construction
- Available with or without tabs for easy peeling
- For use with heat sealers
- Heat sealing offers a 100% effective method of microplate and tube sealing, for complete seal integrity, as well as being quick and cost effective
- Thermal Individual Tube Seal, 96-Format was designed for the heat sealing of 96 well microplates or 96 format cluster tubes, preserving sample integrity and audit trail in compound library and other high-throughput applications
- This is a foil-based heat seal which consists of 96 individual round seals held on a convenient to handle sealing sheet
- The seal is applied using a manual or semi-automated heat sealer, such as our Semi-Automated Sheet Heat Sealer
- After sealing, the microplate frame or the rack can be removed to leave 96 individually sealed wells or tubes
- The individual seals can be removed as required, by hand or using forceps, via the seal removal tab; no polymer residue is left on the well/tube following removal
- The individual seals can also be pierced with a pipette tip manually, using a liquid handling robot

## Key Features

- Peelable
- Pierceable
- Seals polypropylene
- 96 individual foil-based seals held on an easy to handle sealing sheet
- Good solvent resistance, including DMSO
- Free from DNase, RNase, and human genomic DNA, endotoxin/pyrogen free



## Use

- Air-tight sealing that works as an impenetrable barrier for added sample security
- Compatible with 96 well microplates and 96 format racked tubes
- For use with manual or semi-automated heat sealers, such as our Semi-Automated Sheet Heat Sealer
- Tabs for easy removal: hold the tube and peel the tab upwards with forceps or fingers
- Engineered to come away cleanly, leaving no residue, for easy resealing
- Suitable for long term storage and sample shipping
- Suitable for high temperature incubations
- Suitable for cryogenic storage\*

## Options

- Sheet format: individual spots with tabs for easy peeling
- Sheet format: individual spots without tabs

## Ordering Information

<b>66-1001</b>	<b>Thermal Seal, Individual, with tab for manual peeling, 96 Tube Seals per sheet, 50 sheets per case</b>
<b>66-1021</b>	<b>Thermal Seal, Individual, without tab, 96 Tube Seals per sheet, 50 sheets per case</b>

*\*Not for use in liquid phase nitrogen*

# Heat Sealing Consumables Comparison & Instrument Compatibility Table

	Clear Heat Seals				Peelable Heat Seals		
Name	Clear Heat Seal	Clear Weld Heat Seal	Clear Heat Seal Easily Pierceable	Clear Heat Seal Plus	Peel Heat Seal	Universal Peel Heat Seal	DMSO Resistant Peel Heat Seal
<b>Specifications</b>							
Application	qPCR Short term compound storage	PCR, esp. water bath cyclers qPCR Storage & disposal of hazardous materials	qPCR and for use with ABI 3730 Sequencer	Homogenisation or disruption of seeds or other material, e.g. bead mill applications	Low temperature compound storage Short term room temperature compound storage (<5 days) PCR	Low temperature compound storage High temperature applications PCR	Low/room temperature compound storage with DMSO & other organic solvents
Special Properties	Good optical clarity Moderate solvent resistance	Good optical clarity Resistance to DMSO	Good optical clarity Some solvent resistance	High tensile strength	Can be peeled directly from -80°C freezer Moderate resistance to solvents at room temperature	Moderate solvent resistance Re-sealable with another Universal Peel Heat Seal	Can be peeled directly from -80°C freezer High resistance to solvents even at elevated temperatures
Seal Integrity Min Temperature	-80°C	-80°C	-20°C	-80°C	-80°C	-80°C	-80°C
Seal Integrity Max Temperature	80°C (or 110°C with pressurized heated PCR lid)	110°C	80°C (or 110°C with pressurized heated PCR lid)	80°C (or 110°C with pressurized heated PCR lid)	90°C (or 110°C with pressurized heated PCR lid)	90°C (or 110°C with pressurized heated PCR lid)	40°C
Pierceable			✓			(✓)	
Peelable	✓			✓	✓	✓	✓
RNase/DNase free	✓	✓	✓	✓	✓	✓	✓
Material	Laminate	Polymer	Polymer	Polymer	Laminate	Laminate	Laminate
Seals to	PP, PE, PS, PC, COC	PP	PP, PE, PS, COC	PP, PS, COC	PP, COC	PP, PE, PS, PC, COC	PP, PE, COC
Sealing parameters with 96 Well PP Plates	175-185°C 2-3 s	175-185°C 2-3 s	165-175°C 3 s	175-185°C 2-3 s	175-185°C 3 s	175°C 2 s	175-185°C 3 s
Sealing parameters with 384 Well PP Plates	165-180°C 3 s	170-175°C 2-3 s	165-175°C 2 s	165-180°C 3 s	170-175°C 2-3 s	175°C 2 s	170-175°C 2-3 s
Sealing parameters with Optically Clear Tissue Culture Plates	185-200°C 3 s	N/A	175-185°C 2-3 s	185-200°C 3 s	N/A	180°C 2 s	N/A
Product Codes/Instrument Compatibility							
Compatible with Azena Automated Roll Heat Sealer   Thermo Fisher ALPS 300™ and ALPS 3000™   KBiosystems Wasp™ and Chameleon™   KBioscience FlexiSeal and Cube							
Roll, 78 mm width	4ti-0540	4ti-0573	4ti-0580	4ti-0549	4ti-0520	4ti-0523	4ti-0585
Roll, 78 mm width, short roll*	4ti-0540/80	4ti-0573/122	4ti-0580/122		4ti-0520/122		4ti-0585/100
Sample roll, 78 mm width	4ti-0540S	4ti-0573S	4ti-0580S	4ti-0549/S	4ti-0520S	4ti-0523S	4ti-0585S
Compatible with Agilent (Velocity 11) PlateLoc®							
Roll, 115 mm width	4ti-0542	4ti-0574	4ti-0582	4ti-0548	4ti-0522	4ti-0524	4ti-0586
Sample roll, 115 mm width	4ti-0542S	4ti-0574S	4ti-0582S	4ti-0548/S	4ti-0522S	4ti-0524S	4ti-0586S
Compatible with Azena Portrait Heat Sealer							
Roll, 78 mm width, large core	4ti-0540/REMP						4ti-0585/REMP
Compatible with Azena Landscape   Stacking Heat Sealers							
Roll, 115 mm width, large core	4ti-0542/REMP						4ti-0586/REMP
Compatible with Azena Semi-Automated Sheet Heat Sealer   Thermo Fisher ALPS™ 25 and ALPS™ 50   KBiosystems E-Fly 2   Azena Easy Sealer							
Sheets	4ti-0541	4ti-0575	4ti-0581	4ti-05481	4ti-0521	4ti-05231	4ti-0587
Compatible with Azena Semi-Automated Sheet Heat Sealer							
Individual Access, sheets					4ti-0521/RA-TAB 4ti-0521/RA-8		
Compatible with Azena Automated Individual Access Heat Sealer							
Individual Access, roll, 100 mm width					4ti-0522/RA-TAB		

\* For use with the Azena Automated Roll Heat Sealer when using lower roll position and the optional dust cover for protection of the roll · \*\* NOT compatible with Agilent (Velocity 11) PlateLoc®  
Azena US, Inc. recognizes that designated trademarks and brands are the property of their respective owners.

Pierceable Heat Seals		Foil Heat Seals			Gas Permeable Heat Seals	
Pierce Heat Seal	Pierce Heat Seal Strong	Foil Heat Seal	Polystyrene Foil Heat Seal	Thermal Bond Heat Seal	Gas Permeable Heat Seal	Gas Permeable Clear Heat Seal
PCR Compound storage Sample shipping	PCR Compound storage Sample shipping	Low temperature compound storage Short-term room temperature compound storage PCR	Low temperature compound storage Short-term room temperature compound storage PCR	Low temperature transportation & storage PCR, esp. water bath cyclers Storage of organic solvents, acids & alkalines	Cell culture Over night incubation Seed and insect storage	Storage e.g. for seeds or insects
Easily pierceable Resistant to DMSO Re-sealable with another Pierce Heat Seal Color print identifies non-sealing surface	Easily pierceable Resistant to DMSO Re-sealable with another Pierce Heat Seal Color print identifies non-sealing surface	Re-sealable with another Foil Seal Resistant to DMSO Color print identifies non-sealing surface	Re-sealable with another Foil Seal Resistant to DMSO	Very strong seal with PP Resistant to DMSO and other solvents	Small pore size of 20 µm allows gaseous exchange & limits evaporation Gas permeability: 180 m <sup>3</sup> /m <sup>2</sup> /day Moisture vapor transmission: 20g/m <sup>2</sup> /day	3 mm slits across entire surface of seal makes this permeable to gases
-20°C	-20°C	-20°C	-20°C	-200°C	-20°C	-80°C
120°C	120°C	110°C	110°C	110°C	80°C	100°C material integrity (not seal)
✓	✓	✓	✓	✓	✓	✓
		✓	✓	✓	✓	✓
✓	✓	✓	✓	✓	✓	✓
Foil	Foil	Foil	Foil	Laminate	Woven material	Laminate
PP, PS	PP, COC	PP, PS	PP, PS, PC	PP	PP, PS, COC	PP, PE, PS, COC
160-175°C 2 s	170-180°C 2 s	165-180°C 2 s	165-180°C 2 s	170-180°C 2-3 s	170°C 2 s	175-185°C 2-3 s
160-175°C 2 s	170-180°C 2 s	165-175°C 2-3 s	165-175°C 2-3 s	160-170°C 2 s	170°C 2 s	165-180°C 3 s
185-200°C 3 s	180-200°C 3 s	185-200°C 3 s	185-200°C 3 s	N/A	170°C 2 s	185-200°C 3 s
4ti-0530	4ti-0538	4ti-0535	4ti-0545	4ti-0590	4ti-0598	4ti-0540/SLIT
4ti-0530/122		4ti-0535/122	4ti-0545/122	4ti-0590/100	4ti-0598/122	
4ti-0530S	4ti-0538S	4ti-0535S	4ti-0545S	4ti-0590S	4ti-0598S	4ti-0540/SLIT/S
4ti-0532	4ti-0539	4ti-0537	4ti-0546	4ti-0592**	4ti-0599**	
4ti-0532S	4ti-0539S	4ti-0537S	4ti-0546/S	4ti-0592S**	4ti-0599S**	
4ti-0530/REMP		4ti-0535/REMP				
4ti-0532/REMP		4ti-0537/REMP				
4ti-0531	4ti-05381	4ti-0536	4ti-0547	4ti-0591	4ti-0597	4ti-0541/SLIT
4ti-0531/RA	4ti-05381/RA					
4ti-0532/RA	4ti-0539/RA					

Azenta recognizes that designated trademarks and brands of the Instrument Compatibility Table are the property of their respective owners.

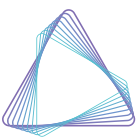

**AZENTA**  
LIFE SCIENCES

# Thermosensitive Color Forming Film



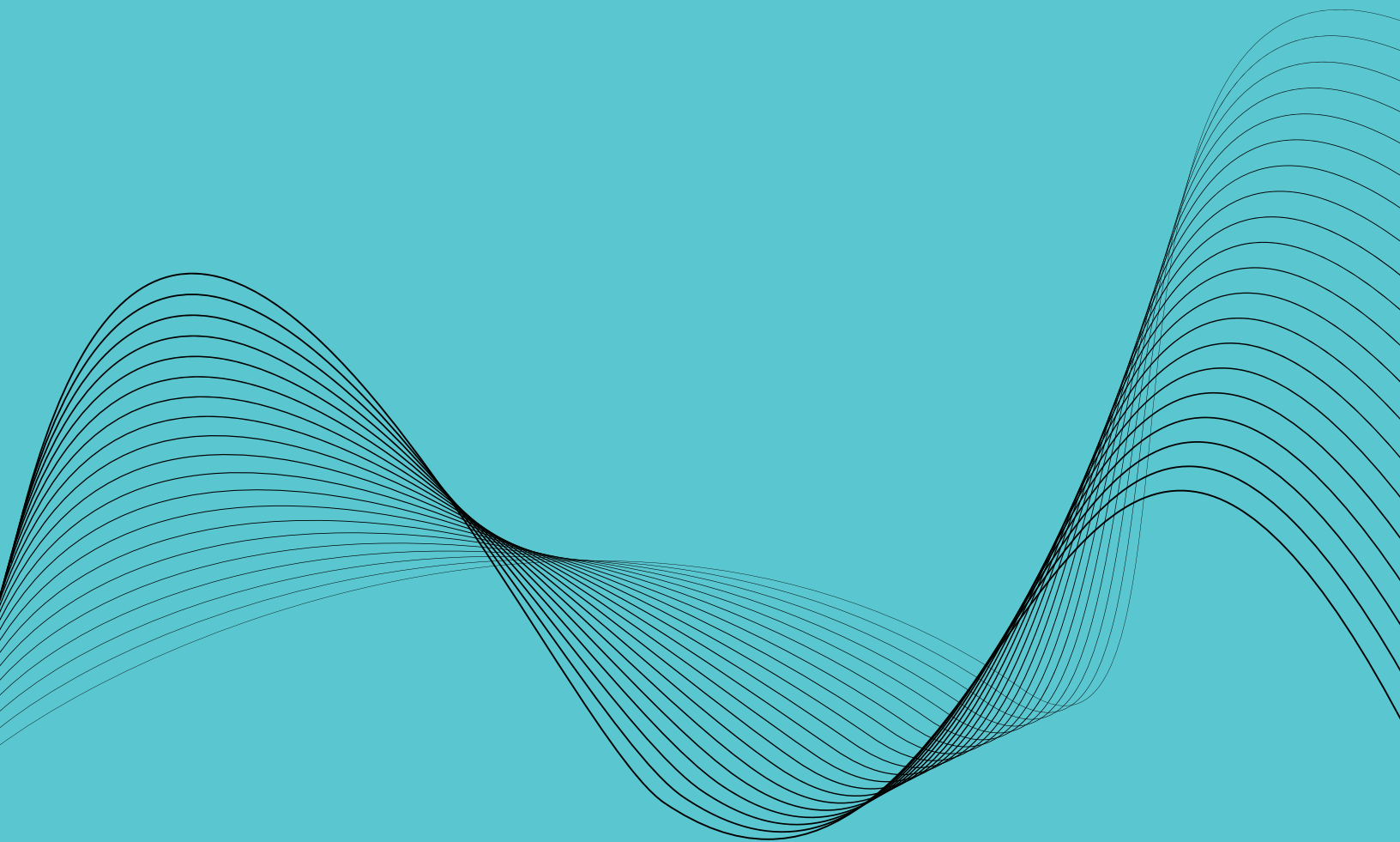

**AZENTA**  
LIFE SCIENCES

# Thermosensitive Color Forming Film

Thermosensitive color-forming film; for evaluation of consistent temperature across a heating block; to be used in conjunction with roll fed or sheet fed heat sealing instruments

- Azenta Thermal Test Film (TTF) can be used in conjunction with a roll fed (e.g. Azenta Automated Roll Heat Sealer) or sheet fed (e.g. Azenta Semi-Automated Sheet Heat Sealer)
- It checks the uniformity and reproducibility of the heat sealing block of the instrument
- The film can be used to effectively test the temperature of the heating block between 160°C and 200°C

## Key Features

- The Thermal Test Film has a thermosensitive color-forming layer plus a protective layer, both attached to the base material
- Depending on the temperature applied to the film, a color is produced in varying density and hue, giving a perfect image of heat distribution across the heating block of your heat sealer
- The color varies according to dwell time and temperature
- The shorter the duration, the paler and more blueish the color
- The longer the duration, the more saturated and reddish the color

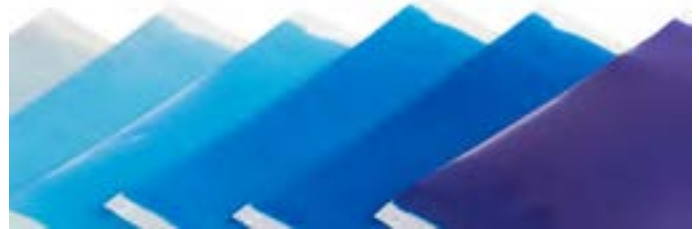

## Specifications

Parameter	Value
Sealing temperature range	160 °C to 200 °C
Recommended ambient temperature	15 °C to 30 °C
Recommended ambient humidity	35% RH to 80% RH

## Ordering Information

<b>4ti-0640</b>	Thermosensitive Color Forming Film, used to check uniformity and reproducibility of a heat sealing block, 25 sheets (125 x 80 mm)
<b>4ti-0641</b>	Thermosensitive Color Forming Film, starter kit, 10 sheets (125 x 80 mm) and 1 silicone pad
<b>4ti-0642</b>	Thermosensitive Color Forming Film, roll kit, 1 roll (1m x 80 mm) and 1 silicone pad

## Thermal Test Film Color Chart

Temperature/Duration	150°C	160°C	170°C	180°C	190°C	200°C	210°C
1 second							
10 seconds							
60 seconds							

Note: This color chart is just an example based on the results of the tests performed in our laboratories. Before using the Thermal Test Film, a similar chart needs to be created that is based on your actual measurement conditions





**AZENTA**  
LIFE SCIENCES

# Automated Roll Heat Sealers



# Automated Roll Heat Sealer



The Automated Roll Heat Sealer enables up to 5,000 perfect seals without manual user intervention, providing a true walk-away system. The main advantage of the Automated Roll Heat Sealer is that it is powered by electric motors, with no requirement for any air supply. This enables the Automated Roll Heat Sealer to generate a reliable and consistent sealing pressure, resulting in superior seal uniformity. In addition, it provides the user the flexibility to use this instrument without the need for an external air supply, enabling ease-of-use as a stand-alone unit on a lab bench or within integrated robotic set-ups. Consistent sealing is achieved through a fixed high sealing pressure and accurate time and temperature controls, ensuring reproducible seal uniformity on the widest range of plates. The high-performance heating block design enables rapid heating with no delay between seals, and provides a uniform temperature across the entire heating block. The Automated Roll Heat Sealer is compatible with a wide range of SBS footprint plates, including all PCR plate formats from 96 to 1536 wells, assay plates, deep well storage plates and microplates. The Automated Roll Heat Sealer can be used with the wide range of sealing materials that Azenta offers, including gas permeable seals with no further instrument modification, enabling a wide range of applications.

- Unrivalled sealing performance and consistency; 5,000 perfect seals without intervention
- SiLA compatible; Easy integration into robotic systems
- Powerful electric motor generates consistent sealing pressure for superior sealing uniformity
- High-performance heating block design generates uniform temperature across entire heating block

## Features

- Powerful electric motor drives plate sealing mechanism
- SiLA compatible
- Compatible with a wide range of plates and seals; 2 positions for different roll sizes
- Variable time and temperature controls
- Seal cycle time < 15 seconds
- High-performance heating block design
- Color touch screen with intuitive user interface
- Unlimited password protected protocols
- Auto standby mode
- Optional roll cover
- 2 year warranty

*Color touch screen with intuitive user interface – ease of use*



## Benefits

- Reliable and consistent sealing pressure; Superior sealing uniformity; No requirement for any air supply
- Easy integration into robotic systems through plug & play
- Flexibility with a wide range of consumables including gas permeable seals without instrument modification
- Enables optimization of any seal / plate type
- Time-saving
- Rapid heating, no delay between seals; Uniform temperature across entire heating block, +/- 1 degree edge-to-edge, corner-to-corner
- Ease of use, saving time
- Save personalized and SOP-set temperatures and times
- Energy-saving; prolongs component life
- Seal protection for sensitive applications
- Instrument reliability



**AZENTA**  
LIFE SCIENCES

## Automated Roll Heat Sealer

### Providing The Perfect Solution For Automated Heat Sealing

#### Plug and Play Robotic Integration

- The automated Roll Heat Sealer is compliant with SiLA standards for rapid integration of automated systems ([www.sila-standard.org](http://www.sila-standard.org)). This means it can be “plug and play” connected with other instruments, such as readers, robotic arms and liquid handlers, to give a custom automated system without the need to write expensive custom drivers.
- The Automated Roll Heat Sealer is extremely versatile leaving you the freedom to expand and reconfigure your systems such as adding robotic plate handling.
- Full communication protocol available — operate the instrument and record sealing conditions for each seal using the RS232 communication port
- SiLA compatible — quick and easy integration with other SiLA compliant devices using the SiLA driver



#### Technical Specifications

Parameter	Value
Dimensions (W x L x H)	230 x 507 x 276 mm
<i>Please note: Additional space is required if large seal rolls are used</i>	
Sealing Temperature Range	100-195°C
Sealing Time Range	0.1-10 sec
Weight (without roll)	27 kg
Power Supply	V in: AC 100-240 V V out: DC 24 V 320 W
Power Consumption	700 W (max)
Working Temperature Range	10-30°C
Operating Humidity (RH)	0-85%
Connection	RS-232 serial port, USB port



*Flexibility of seal material choice - Azenta offers a wide range of sealing films and foils*



*Compatibility with a wide range of plate types - two adapters supplied for optimal sealing results, with custom adapters available on request*

## Ordering Information

#### Automated Roll Heat Sealer

Includes: Power cord, manual, plate support adapters A (4ti-0665-2) and B (4ti-0665-3), 24 months parts and labor warranty

**4ti-0665**

Automated Roll Heat Sealer, for use with adapters A and B

#### Accessories

**4ti-0665-1**

Automated Roll Heat Sealer Seal Loading Tool, 1 per case

**4ti-0665-2**

Automated Roll Heat Sealer Adapter, adapter A

**4ti-0665-3**

Automated Roll Heat Sealer Adapter, adapter B

**4ti-0665-4**

Automated Roll Heat Sealer Roll Holder Set. 1 kit

**4ti-0665-5**

Automated Roll Heat Sealer Vacuum Cups, front, set of 2

**4ti-0665-6**

Automated Roll Heat Sealer Vacuum Cups, back, set of 2

**4ti-0665-8**

Automated Roll Heat Sealer Dust Cover, clear plastic roll

**4ti-0665-41**

Automated Roll Heat Sealer SiLA Driver



**AZENTA**  
LIFE SCIENCES

# Automated Individual Access Heat Sealer



The Automated Individual Access Heat Sealer is an automated roll heat sealer for higher throughput capable of sealing individual wells or tubes, enabling researchers to leverage the benefits of the Azenta Individual Access range whilst maintaining the gold standard heat sealing provided by the Azenta Automated Roll Heat Sealer.

## Concept

Individual access utilizes a plate with individually removable wells, together with seals consisting of individual foil seal spots. This enables sealing of individually accessible tubes and thereby provides flexibility for single access or placement of tubes within a rack. In addition, the Automated Individual Access Heat Sealer also has the ability to seal custom shaped consumables with custom shaped seals to accommodate tailor-made needs. The resulting individual access of tubes and consumables through sealing of individual tubes and custom shaped consumables enables high throughput manufacturing but shipment of individual product. End-users can then utilize tubes individually as needed by taking one well at a time.



## Features

- Individual sealing of plate wells or tubes
- Color touch screen with intuitive user interface
- Variable time and temperature controls
- Compatibility with wide range of plates and seals
- Ability to seal custom shapes with custom seals
- Unlimited password protected protocols
- SiLA compatible
- Rapid heating
- Auto standby mode
- 2 year warranty



## Benefits

- Enables individual access to plate wells or tubes and allows high throughput manufacturing but shipment of individual product
- Ease of use, saving time
- Enables optimization of any seal and plate type
- Enables specific requirements and unique applications
- Custom potential for tailor-made consumables
- Save personalized and SOP-set temperatures and times
- Easy integration into robotic systems through plug & play
- Fast start-up time; block uniformity maintained to  $\pm 1^{\circ}\text{C}$
- Energy saving; prolongs component life
- Instrument reliability

## A solution for:

- Diagnostic Kit Manufacturers
- Oligonucleotide Production
- Synthetic Biology
- Sample Storage
- Individual Access Users
- Antibody Extraction

## Ordering Information

<b>Automated Individual Access Heat Sealer</b>	
Includes: Power cord, manual, plate support adapters, 24 months parts and warranty.	
<b>59-1000</b>	<b>Automated Individual Access Heat Sealer</b>
<b>Accessories</b>	
<b>59-1001</b>	<b>Automated Individual Access Heat Sealer Seal Loading Tool</b>
<b>59-1004</b>	<b>Automated Individual Access Heat Sealer Plate Support Adapter, A</b>
<b>59-1003</b>	<b>Automated Individual Access Heat Sealer Waste Collection Core</b>
<b>59-1002</b>	<b>Automated Individual Access Heat Sealer Spindle Support</b>

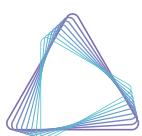

# Semi-Automated Sheet Heat Sealer



# Semi-Automated Sheet Heat Sealer

The Semi-Automated Sheet Heat Sealer is compatible with a wide range of seals and plates of differing designs and heights.

With variable temperature and time settings, sealing conditions are easily optimized to produce a tight seal, eliminating sample loss.

Plate and seal are placed on the holder, the "Operate" button pressed and the drawer automatically closes. The sealing process is controlled by an electric mechanism.

Heat sealers provide a mechanism for controlled plate sealing, eliminating variation and giving consistent sealing every time.



## Features

- Variable time and temperature control
- Simple, three button operation
- Real-time temperature display
- Auto stand-by function and switch-off mode
- Compatible with all SBS microplates
- Small footprint
- RS-232 serial port
- SiLA compatible
- 12 month warranty

## Benefits

- Enables optimization of any seal / plate type
- Ease of use
- Rapid heating element enables fast start-up, saving time
- Conserves energy by reducing temperature of heating element down to 60°C or switching off after defined time
- Flexibility for wide range of consumables, eg competitor plates
- Minimal bench space
- Enables full integration within robotic automation systems
- Easy integration with SiLA compliant devices using SiLA driver
- Instrument reliability

## Technical Specifications

Parameter	Value
Dimensions (W x L x H)	181 x 275 x 310 mm
Sealing Temperature Range	60-200°C
Sealing Time Range	0-10 sec
Weight	9 kg
Power Supply	110/230V
Power Consumption	300 W (max)
Connection	RS-232 serial port



## The Semi-Automated Sheet Heat Sealer Is Compatible With A Wide Range Of Seals & Plates Of Differing Designs & Heights



Reproducible Sealing

### Adapters

The Semi-Automated Sheet Heat Sealer employs a unique and cost saving adapter system

- Deep well plates and most other skirted plates can be sealed on the standard plate support adapter (59-2001)
- For all other 96 well PCR plates, an additional plate support adapter (59-2003, optional extra) must be used
- Both adapters can also be combined for easier handling of shallow plates such as 384 well PCR plates.
- For best sealing results with Individual Access seals, 8 different adapters are available to offer the perfect plate support and seal alignment



Highest Flexibility

### Sealing Aids

- For better sealing of films which have a tendency to curl, Azenta offers sealing aids
- A sealing frame for use with all other plate designs is supplied when ordering the optional 59-2003 plate support adapter

### Plate Formats

The following plate formats can be used with the appropriate plate adapter:

- Standard SBS footprint PP & PS plates & deepwell blocks
- PCR plates (skirted, semi-skirted and non-skirted formats)

## Ordering Information

<b>Semi-Automated Sheet Heat Sealer</b> Includes: Power cord, manual, standard plate support adapter (59-2001), 12 months parts and labour warranty	
<b>59-2000</b>	<b>Semi-Automated Sheet Heat Sealer</b> , includes adapter (59-2001)
<b>Accessories</b>	
<b>59-2001</b>	<b>Semi-Automated Sheet Heat Sealer Adapter</b> , for skirted 96 and 384 well plates, 1 adapter per case
<b>59-2002</b>	<b>Semi-Automated Sheet Heat Sealer Adapter</b> , for Roche 1536 well PCR plates, 1 adapter per case
<b>59-2003</b>	<b>Semi-Automated Sheet Heat Sealer Adapter</b> , for 96 well PCR plates, includes Semi-Automated Sheet Heat Sealer Sealing Frame (59-2009) 1 adapter and frame per case
<b>59-2004</b>	<b>Semi-Automated Sheet Heat Sealer Adapter</b> , for 384 well PCR plates, 1 adapter per case
<b>59-2005</b>	<b>Semi-Automated Sheet Heat Sealer Adapter</b> , for Individual Access plates, 1 adapter per case
<b>59-2006</b>	<b>Semi-Automated Sheet Heat Sealer Adapter</b> , for 96 and 384 well storage plates, 1 adapter per case
<b>59-2007</b>	<b>Semi-Automated Sheet Heat Sealer Adapter</b> , for 4TI-LB0109 and 96 well PCR plates, 1 adapter per case
<b>59-2008</b>	<b>Semi-Automated Sheet Heat Sealer Weighted Sealing Platen</b> , 1 platen per case
<b>59-2009</b>	<b>Semi-Automated Sheet Heat Sealer Sealing Frame</b> , for use with Semi-Automated Sheet Heat Sealer Adapter, for use with 59-2003, 1 frame per case



59-2001  
Plate Support  
Adapter, Standard



59-2003  
Plate Support  
Adapter, PCR 96



59-2005  
Plate Support  
Adapter, Individual  
Access, Low Profile



59-2008  
Weighted Sealing  
Platen



59-2009  
Sealing Frame







**AZENTA**  
LIFE SCIENCES

# Automated Plate Seal Remover



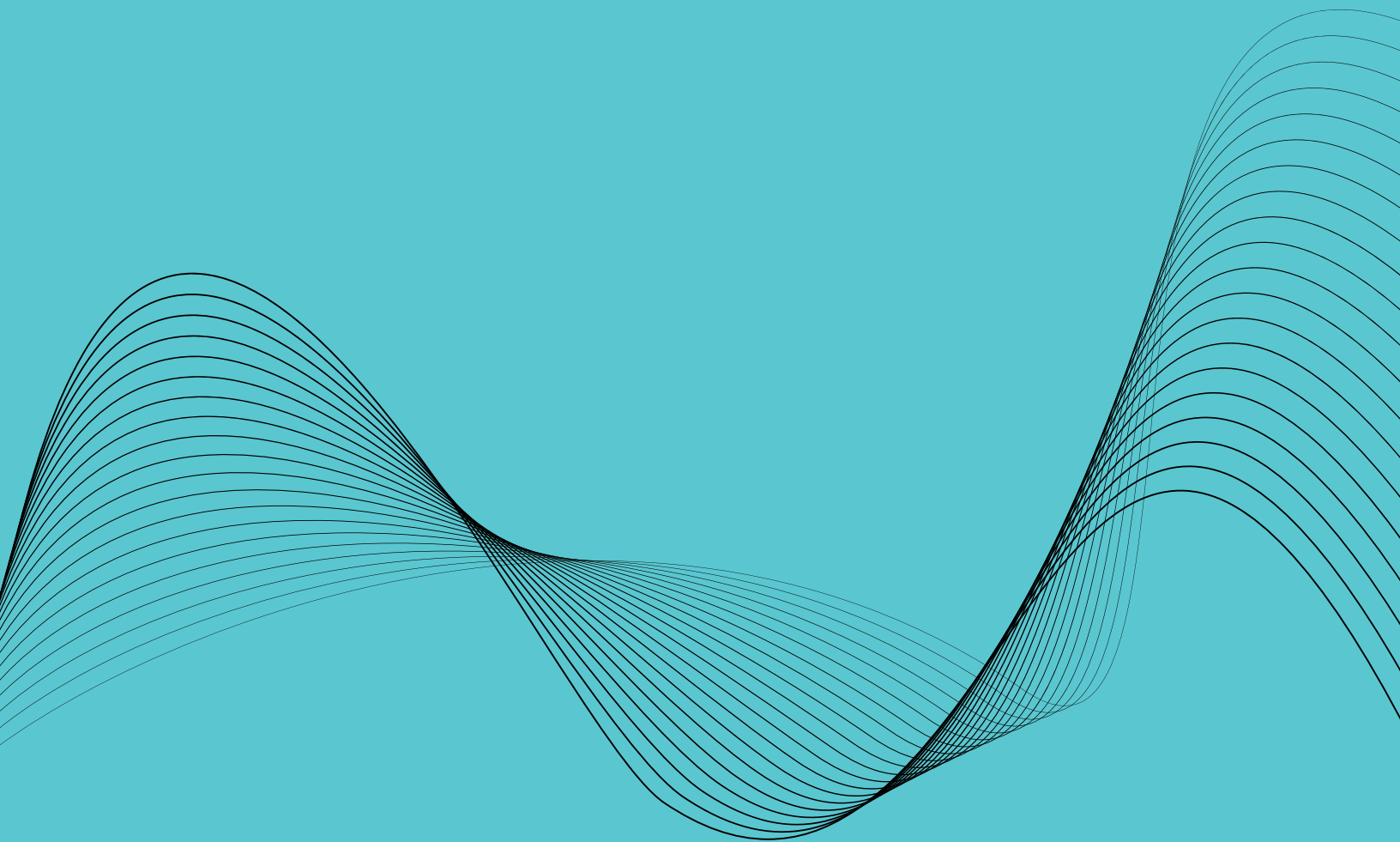

**AZENTA**  
LIFE SCIENCES

# Automated Plate Seal Remover

Automatically removes seals from a wide range of microplate types with the single touch of a button.

A robust and elegantly-simple automated system, the Automated Plate Seal Remover eliminates the need for repetitive, manual removal of plate seals and enables the adoption of the gold-standard operating model (sealed plates, no lids).

The Automated Plate Seal Remover Tape eliminates the need for mechanical removal mechanisms which are often prone to failure. Automated Plate Seal Remover is highly reliable and can be used manually or integrated into automated systems with external robotics.

## Key Features

### Compatible with Virtually All Plate Types and Seal Types

- Can be used with a wide variety of microplates, including full-skirted PCR plates, low-base microplates and deep-well (up to 2ml) plates
- Compatible with a variety of full-plate seals, including heat and pressure applied seals
- Uses proprietary Automated Plate Seal Remover Tape to de-seal microplates, up to 400 seal removals per roll

### Preserves Sample Integrity

- Eliminates cross contamination common with manual seal removal techniques
- Supports Quality Control measures requiring samples to be sealed until their moment of use
- Holds the plate down whilst the seal is peeled away from the plate, eliminating another contamination issue
- Operating mode minimizes plate or seal damage
- When used as part of an integrated workflow, seal removal verification feature reduces plate handling errors

### Easy to Use, Easy to Integrate

- Can be used as a standalone system, or integrated into automated and robotic workflows via Serial RS232 remote interface
- One-touch, push-button operation to de-seal plates makes the Automated Plate Seal Remover an ideal standalone device for busy laboratories
- Capacity to remove up to 200 plate seals per hour
- Robust, time-proven device with hundreds of units placed globally in a range of manual and automated environments



## Specifications

Parameter	Value
Seal Removal Capacity	Up to 400 per Tape Roll
Seal Verification Sensor	Reflective with Sensitivity Adjustment
Communication	Serial RS232
Motion Parameters	Tape Adhere Time, De-seal Speed, Plate Output Orientation, Begin Peel Location
General Parameters	Auto Tape Advance, Plate Verification Menu Language
Weight	35kg (76lbs)
Power Requirements	115VAC, 4A, 60Hz 230VAC, 2A, 50Hz
Throughput	Up to 200 Plate Seal Removals per Hour

## Ordering Information

<b>Automated Plate Seal Remover</b> Includes: Power cord, manual, plate support adapters, 12 months parts and warranty.	
<b>XP-A_100V</b>	<b>Automated Plate Seal Remover, 100V,</b> version for Asia; 1 unit
<b>XP-A</b>	<b>Automated Plate Seal Remover, 115V,</b> version for North America; 1 unit
<b>XP-A_230V</b>	<b>Automated Plate Seal Remover, 230V,</b> version for Europe; 1 unit
<b>Compatible Tapes</b>	
<b>X-Tape_2000</b>	<b>Automated Plate Seal Remover Tape,</b> 5 spools per case

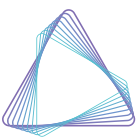

**AZENTA**  
LIFE SCIENCES

# Adhesive Sealing Consumables & Sealing Accessories



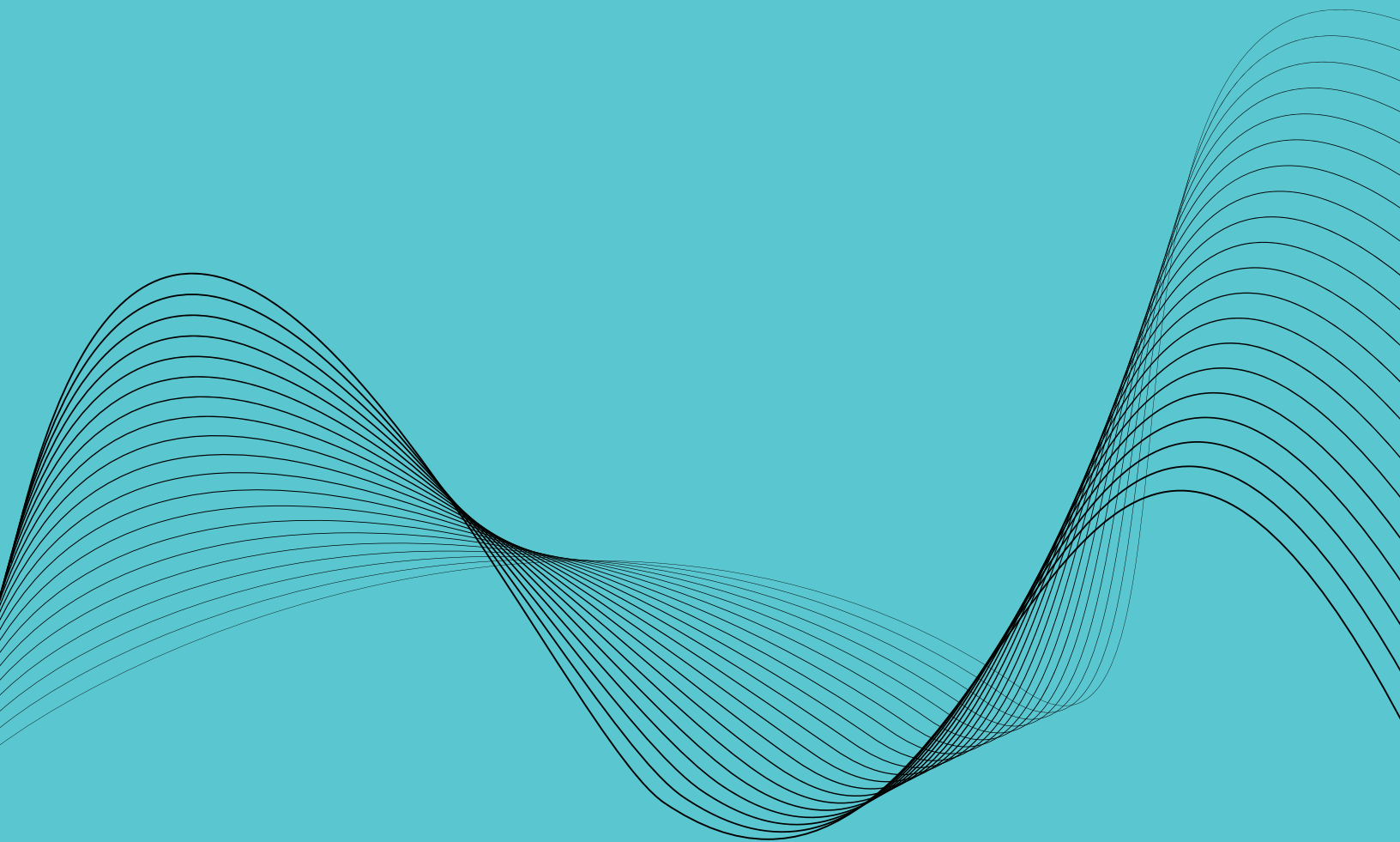

**AZENTA**  
LIFE SCIENCES

# Adhesive Sealing Consumables & Sealing Accessories

Adhesive seals provide a versatile, yet robust, method for protecting samples. The seals are supplied as sheets and some are also available in roll format. Most adhesive seals are supplied with convenient tabs on both ends for easy application and removal. These tabs also enable easy peeling to remove a seal without leaving adhesive residue on the sealing surface.

All our seals are produced and processed under strictly controlled environmental conditions and certified free from DNase, RNase and human genomic DNA.

To choose the most suitable seal, please refer to the comparison table on page 270 which describes the recommended applications and technical features of each seal.

To obtain the best sealing results with adhesive seals, we strongly recommend the use of high quality plates with raised rim sealing rings for optimal sealing integrity and guaranteed flatness. All Azenta PCR plates are designed with these features.

To improve seal application by ensuring even pressure is applied, we offer a seal roller and a seal applicator, for complete and secure application of all our adhesive seals. We also offer supplementary products like the compression pad, for details see page 269.

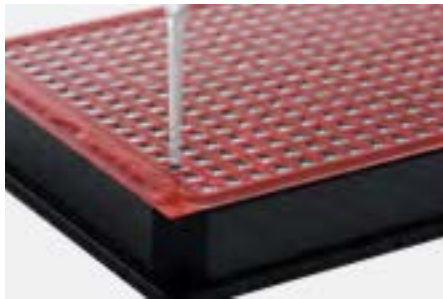



# PCR Seal

**Clear adhesive film, strong adhesive, peelable; suitable for PCR and optical applications; available as a full sheet, perforated for tearing into 8 well strips or 12 well strips**

- Our PCR Seal is a durable transparent polyester film with a strong adhesive layer
- The seal enables a high integrity and efficiently prevents sample evaporation
- Recommended for PCR, qPCR, and other optical applications (e.g. fluorescence or colorimetric measurements) as well as sample storage
- The PCR Seal is also available in two flexible formats with perforated sheets, to enable tearing into 8 well and 12 well strips, respectively
- Allows for sealing of complete 96 well plates, but also individual or multiple Breakable Horizontally or Vertically or Breakable Vertically strips, perfectly complementing these products
- For all adhesive seals, the best sealing results are achieved using the hand held Adhesive Seal Roller (4ti-0502)

## Key Features

- Non-pierceable, please refer to our PCR Foil Seal Strong for a pierceable variant
- Peelable
- Seal integrity range: -20°C to 110°C
- Non-gamma treated
- Free from DNase, RNase, and human genomic DNA

## Use

- Applications: PCR, qPCR
- Removal: features adhesive-free end tabs for easy removal, will not leave a sticky residue on the plate surface following removal



Seal Integrity Temperature Range

-20°C

110°C

\*110°C with pressurized heated lid

Peelable



## Options

- Sheet format: 135 x 80 mm, to fit all standard SBS footprint PCR and qPCR plates, microplates, assay and storage plates
- Perforated sheet format: 115 x 100 mm, for tearing into 8 well strips
- Perforated sheet format: 137 x 71 mm, for tearing into 12 well strips

## Ordering Information

<b>4ti-0500</b>	PCR Seal, clear adhesive film, strong adhesive, 100 sheets (135 x 80mm) per case
<b>4ti-0500/8</b>	PCR Seal 96/8, clear adhesive film, vertically perforated, strong adhesive, 100 sheets (115 x 100mm) per case
<b>4ti-0500/12</b>	PCR Seal 96/12, clear adhesive film, horizontally perforated, strong adhesive, 100 sheets (137 x 71mm) per case

# Optically Clear Windowed qPCR Seal

## Adhesive film with 96 optically clear windows, peelable, suitable for qPCR and optical applications

- These unique seals combine the strong sealing integrity of our PCR Seal with improved optical properties, thanks to the 96 adhesive-free windows
- The seal is made of a durably transparent polyester film, and a strong adhesive is applied across the seal, apart from the 96 round windows
- The Optically Clear Windowed qPCR Seal is recommended for qPCR and other optical applications, such as fluorescence or colorimetric measurements
- For all adhesive seals, the best sealing results are achieved using the hand held Adhesive Seal Roller (4ti-0502)

## Key Features

- Non-pierceable
- Peelable
- Seal integrity range: -20°C to 110°C
- Free from DNase, RNase, and human genomic DNA

## Use

- Applications: qPCR, plate readers
- For 96-well microplates only
- Removal: will not leave a sticky residue on the plate surface following removal
- Suitable for cutting to fit part plates



\*110°C with pressurized heated lid



## Options

- Sheet format: 133 x 76 mm, to fit all standard SBS footprint PCR and qPCR plates, microplates, assay and storage plates with 96 round wells
- Non-gamma treated as standard; gamma treatment available upon request

## Ordering Information

4ti-0565*	Optically Clear Windowed qPCR Seal, adhesive film with 96 optically clear windows, 100 sheets (133 x 76mm) per case
-----------	---

*\*Not available for purchase in or onwards distribution to the USA*

# qPCR Adhesive Seal

**Optically clear adhesive film, pressure activated adhesive, peelable; suitable for qPCR and other imaging techniques including crystallization**

- Optically clear seal specifically developed for optical applications, particularly qPCR
- It is non sticky when removed from the packaging; this aids handling when wearing gloves
- The adhesive is contained within small capsules, allowing light to pass through to ensure the optical clarity of the seal
- When the seal is in position, pressure can be applied to burst the capsules, releasing a strong adhesive only where the seal touches the raised well rims of the plate - the rest of the seal area above the wells remains optically clear

## Key Features

- Non-pierceable
- Peelable
- Seal integrity range: -80°C to 110°C
- Free from DNase, RNase, and human genomic DNA

## Use

- Applications: qPCR and other fluorescent applications, plate readers, microscopy and protein crystallization (96 or 384 well)
- Removal: will not leave a sticky residue on the plate surface following removal
- Replacement for: ABI® MicroAmp Optical Adhesive film, Absolute qPCR plate seals and Roche LightCycler® sealing foils

## Options

- Sheet format: 140 x 77 mm, to fit all standard SBS footprint PCR and qPCR plates, microplates, assay and storage plates with 96 round wells
- Roll format: 100 m x 80 mm, approx. 700 seals
- Non-gamma treated as standard; gamma treatment available upon request



Seal Integrity Temperature Range	-80°C 110°C
----------------------------------	----------------

\*110°C with pressurized heated lid

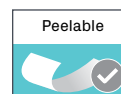

## Specifications

- This is a pressure-activated seal: the adhesive is released when pressure is applied firmly and evenly to the seal
- Our Adhesive Seal Roller and Adhesive Seal Applicator are ideal for use with this product
- We also recommend the use of our Optical Film Compression Pad during PCR with this product

## Ordering Information

<b>4ti-0560</b>	qPCR Adhesive Seal, optically clear film, pressure activated adhesive, 100 sheets (140 x 77mm) per case
<b>4ti-0561</b>	qPCR Adhesive Seal, optically clear film, pressure activated adhesive, 1 roll (100m x 80mm)
<b>4ti-0561S</b>	qPCR Adhesive Seal, optically clear film, pressure activated adhesive, 1 sample roll (5m x 80mm)



**AZENTA**  
LIFE SCIENCES

# PCR Foil Seal

**Pierceable adhesive aluminium foil, strong adhesive, peelable; suitable for high temperature applications**

- This aluminium foil seal has a strong acrylic adhesive which produces a seal of high integrity
- It was developed for PCR and other high temperature applications due to its effectiveness in preventing sample evaporation
- The PCR Foil Seal is pierceable; when pierced, the foil tears in an irregular manner which prevents the formation of a vacuum
- Perforated end tabs for easy application and removal by peeling
- For all adhesive seals, the best sealing results are achieved using the hand held Adhesive Seal Roller (4ti-0502)

## Key Features

- Pierceable
- Peelable
- Seal integrity range: -40°C to 120°C
- Free from DNase, RNase, and human genomic DNA

## Use

- Applications: PCR, incubation, storage
- Suitable for cutting to fit part plates



Seal Integrity  
Temperature Range

-40°C
120°C

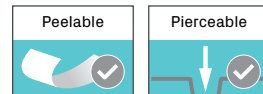

## Options

- Sheet format: 130 x 80 mm, to fit all standard SBS footprint PCR and qPCR plates, microplates, assay and storage plates
- Non-gamma treated as standard; gamma treatment available upon request

## Ordering Information

4ti-0550

PCR Foil Seal, pierceable adhesive aluminium foil, strong adhesive, 100 sheets (130 x 80mm) per case



**AZENTA**  
LIFE SCIENCES

# PCR Foil Seal Strong

**Adhesive aluminium foil, strong adhesive, peelable, pierceable; suitable for high temperature incubations and low temperature storage**

- Our PCR Foil Seal Strong is a pierceable aluminium foil seal with a strong acrylic adhesive, recommended for PCR and low temperature storage
- This seal features all of the advantages of our PCR Seal, but in a pierceable format
- For all adhesive seals, the best sealing results are achieved using the hand held Adhesive Seal Roller (4ti-0502)

## Key Features

- Pierceable
- Peelable
- Seal integrity range: -80°C to 110°C
- Non-gamma treated
- Free from DNase, RNase, and human genomic DNA

## Use

- Applications: PCR, high temperature incubations, low temperature sample storage



Seal Integrity  
Temperature Range

-80°C
110°C

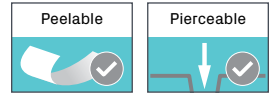

## Options

- Sheet format: 137 x 80 mm
- Non-gamma treated as standard; gamma treatment available upon request

## Ordering Information

**4ti-0500FL**

**PCR Foil Seal Strong, adhesive aluminium foil, strong adhesive, 100 sheets (137 x 80mm) per case**

# DMSO Resistant Foil Seal

**Peelable adhesive foil, strong adhesive, high solvent resistance; suitable for long term storage**

- This aluminium foil seal has a chemically resistant silicone adhesive layer to produce a seal with high levels of solvent resistance, including to Dimethyl Sulfoxide (DMSO)
- For all adhesive seals, the best sealing results are achieved using the hand held Adhesive Seal Roller (4ti-0502)

## Key Features

- Non-pierceable
- Peelable
- Seal integrity range: -20°C to 80°C
- Free from DNase, RNase, and human genomic DNA

## Use

- Applications: long-term plate storage, samples containing <80% Dimethyl Sulfoxide (DMSO) can be stored for up to 5 years
- Removal: this seal will not leave a sticky residue on the plate surface following removal
- Suitable for cutting to fit part plates

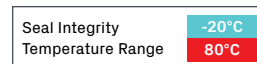

## Options

- Sheet format: 122 x 80 mm, to fit all standard SBS footprint plates, PCR and qPCR plates and part plates, microplates, assay and storage plates
- Non-gamma treated as standard; gamma treatment available upon request

## Ordering Information

4ti-0512

DMSO Resistant Foil Seal, peelable adhesive foil, strong adhesive, high solvent resistance, 100 sheets (122 x 80mm) per case

# Pierceable Film Strong Adhesive, 96 Cross-Cut Windows

**Strong adhesive seal cross-cut windows, peelable, pierceable; suitable for 96 well plates (auto samplers, HPLC, sequencers)**

- This strong adhesive seal was developed to facilitate easy sample removal with a manual or automated system
- The seal is optically clear, being made from a transparent polyester film, and has a strong adhesive applied across the underside of the seal, except for 96 round windows which align to the 96 wells of a plate
- The optical windows are cross-cut, allowing for easy access to the sample wells with a tip or probe with minimal pressure
- For all adhesive seals, the best sealing results are achieved using the hand held Adhesive Seal Roller (4ti-0502)

## Key Features

- Pierceable
- Peelable
- Seal integrity range: -20°C to 110°C
- Non-gamma treated
- Free from DNase, RNase, and human genomic DNA

## Use

- Applications: sample application or retrieval, for use in automated systems and sample analyzers such as HPLC and DNA sequencers
- Removal: will not leave a sticky residue on the plate surface following removal
- Suitable for cutting to fit part plates
- Replacement for: ABI® septa mats on capillary sequencers and to replace silicone and EVA storage plate cap mats

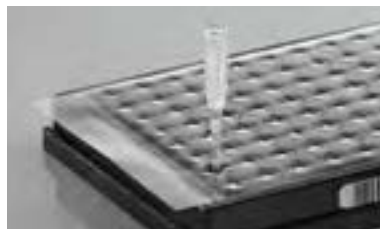

Seal Integrity  
Temperature Range

-20°C
110°C

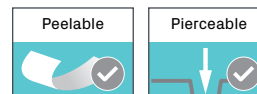

## Options

- Sheet format: 135 x 77 mm, to fit all standard SBS footprint PCR and qPCR plates, microplates, assay and storage plates with 96 round wells
- Non-gamma treated as standard; gamma treatment available upon request

## Ordering Information

<b>4ti-0566*</b>	<b>Pierceable Film, strong adhesive seal with 96 cross-cut windows, 100 sheets (135 x 77mm) per case</b>
------------------	--

*\*Not available for purchase in or onwards distribution to the US*

# Pierceable Film Strong Adhesive, 384 Cross-Cut Windows

**Strong adhesive seal with cross-cut windows, red adhesive, peelable, pierceable; suitable for 384 square well plates**

- This strong adhesive seal was developed to facilitate easy sample removal with a manual or automated system
- A red adhesive is applied across the underside of the seal, except for 384 windows which align to the 384 wells of a plate
- The optical windows are cross-cut, allowing for easy access to the sample wells with a tip or probe with minimal pressure
- For all adhesive seals, the best sealing results are achieved using the hand held Adhesive Seal Roller (4ti-0502)

## Key Features

- Pierceable
- Peelable
- Seal integrity range: -80°C to 120°C
- Adhesive-free windows avoid clogging of tips or needles during piercing
- Pre-slit well centres for access to samples with no force needed for piercing
- No cross contamination
- Good solvent and DMSO resistance
- Non-gamma treated
- Free from DNase, RNase, and human genomic DNA

## Use

- Applications: sample application or retrieval, for use in automated systems and sample analyzers such as HPLC and DNA sequencers



Seal Integrity Temperature Range	-80°C 80°C
----------------------------------	---------------

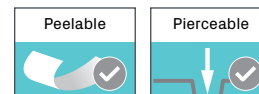

## Options

- Sheet format: 117 x 80 mm, to fit all standard SBS footprint plates, microplates, assay and storage plates with 384 wells with rounded square wells
- Non-gamma treated as standard; gamma treatment available upon request

## Ordering Information

4ti-0566/384

Pierceable Film, strong adhesive seal with 384 cross-cut windows, 100 sheets (117 x 80mm) per case



# Moisture Barrier Seal 24, 96, 384

**Gas permeable adhesive film, optically clear, with adhesive free windows, peelable, pierceable, gamma treated; suitable for cell culture**

- This unique seal has optically clear adhesive free windows; these windows can be imaged through, and also allow for gas exchange
- The clear film is made of a porous material which allows for a uniform air and CO<sub>2</sub> exchange, whilst acting as a moisture barrier and preventing evaporation
- The seal is coated with a strong adhesive (except for the optical windows) which has a high sealing integrity
- This ensures a reliable seal and prevention of well-to-well contamination
- The gas permeable seal enables long term incubations without intervention, whilst allowing for imaging through the optically clear windows
- Can reduce the risk of sample contamination, evaporation and can improve your experimental workflow
- Use of this seal within plate readers can prevent moisture release into the sensitive equipment
- A number of plate reader manufacturers recommend the use of the Azenta Moisture Barrier Seal 24,96,384 (Gas Permeable Moisture Barrier Seal)
- For all adhesive seals, the best sealing results are achieved using the hand held Adhesive Seal Roller (4ti-0502)

## Key Features

- Pierceable
- Peelable
- Seal integrity range: -20°C to 80°C
- Gas permeability rate: 0.6 m<sup>3</sup>/m<sup>2</sup>/day
- Moisture vapor transmission rate: 1 g/m<sup>2</sup>/day
- Optically clear for imaging
- Gamma treated
- Free from RNase and DNase

## Use

- Applications: plate readers, eukaryotic cell culture, bacterial cell culture, long-term incubation, live cell assays, confocal microscopy

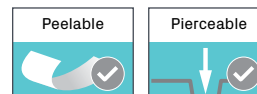

## Options

- Sheet format: 140 x 80 mm (4ti-0516/24) and 137 x 80 mm (4ti-0516/96 and 4ti-0516/384)
- Available with 24/96/384 adhesive free windows for use with 24/96/384 well plates

## Ordering Information

4ti-0516/24*	Moisture Barrier Seal, gas permeable adhesive film, optically clear, with 24 adhesive free windows, gamma treated, 5 x 10 sheets (137 x 77mm) per case
4ti-0516/96*	Moisture Barrier Seal, gas permeable adhesive film, optically clear, with 96 adhesive free windows, gamma treated, 5 x 10 sheets (137 x 77mm) per case
4ti-0516/384*	Moisture Barrier Seal, gas permeable adhesive film, optically clear, with 384 adhesive free windows, gamma treated, 5 x 10 sheets (137 x 77mm) per case

\*Not available for purchase in or onwards distribution to the USA



**AZENTA**  
LIFE SCIENCES

# Cell Culture Adhesive Seal

## Gas permeable adhesive seal, peelable; suitable for cell culture

- Our Cell Culture Adhesive Seal is a gas permeable adhesive seal which seals assay and tissue culture plates, microplates and storage plates
- The Cell Culture Adhesive Seal prevents evaporation and contamination whilst enabling cells to breathe. It is made of a non-woven fiber with an acrylate adhesive layer for effective sealing
- The seal has a low moisture transfer rate and a porosity enabling gas exchange
- Due to its paper-based material it should not be used in wet conditions
- Suitable for cell culture and enables long term culture with significantly reduced evaporation
- For all adhesive seals, the best sealing results are achieved using the hand held Adhesive Seal Roller (4ti-0502)

## Key Features

- Peelable
- Seal integrity range: -20°C to 40°C
- Gas permeability rate: 8,900 m<sup>3</sup>/m<sup>2</sup>/day
- Moisture vapor transmission rate (very low): 4,200 g/m<sup>2</sup>/day
- Air porosity: 10 sec/100 cc/in<sup>2</sup>
- RNase/DNase free

## Use

- Application: bacterial and eukaryotic cell culture

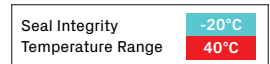

## Options

- Sheet format: 135 x 80 mm
- Available gamma treated (4ti-0517/ST)

## Ordering Information

<b>4ti-0517</b>	Cell culture adhesive seal, gas permeable, 100 sheets (135 x 80mm) per case
<b>4ti-0517/ST</b>	Cell culture adhesive seal, gas permeable, 10x10 sheets (135 x 80mm) per case

# Microplate Seal Low Strength Adhesive Film

**Low strength adhesive film, transparent, peelable; suitable for short term storage**

- This transparent polyester-based film has a low strength adhesive
- It is designed as a low-cost sealing option, and useful for temporary storage and as a cover for applications such as centrifugation
- End tabs allow for easy application and removal
- This seal is removable without residue on the plate
- For all adhesive seals, the best sealing results are achieved using the hand held Adhesive Seal Roller (4ti-0502)

## Key Features

- Non-pierceable
- Peelable
- Seal integrity range: -20°C to 80°C
- Free from DNase, RNase, and human genomic DNA

## Use

- Applications: sample storage (aqueous samples only)
- Suitable for all plate types



Seal Integrity  
Temperature Range

-20°C
80°C



## Options

- Sheet format: 130 x 80 mm

## Ordering Information

**4ti-0510**

**Microplate Seal, low strength adhesive film, transparent, 100 sheets (130 x 80mm) per case**

# Double Sided Re-Sealable Adhesive Film

Double sided adhesive film, black, with 96 holes and a protective liner, peelable; suitable for re-sealing without the need for a heat sealer

- A double sided black adhesive microplate film to facilitate the sealing, accessing (piercing) and resealing of 8 Well PCR Tube Strips (4ti-0753) prior to PCR
- The strips or plates are filled with reagents and sealed with Pierce Heat Seal (4ti-0530) resulting in lowest evaporation and best possible long-term storage
- With the use of a pierceable seal, samples can easily be added at the point of diagnostic use
- The protective Double Sided Re-Sealable Adhesive Film makes sure there will be no damage to the Pierce Heat Seal during transportation
- The film is overlaid and the strips or plates processed with a cutter into individually sealed strips
- The strips can then be transported and opened at a customer site by peeling off the protective layer of the Double Sided Re-Sealable Adhesive Film and accessing the sample through the Pierce Heat Seal
- Can then be resealed with a foil or film which is applied to the exposed black adhesive without the need for a heat sealer
- For all adhesive seals, the best sealing results are achieved using the hand held Adhesive Seal Roller (4ti-0502)

## Key Features

- Peelable
- Resealable
- Seal integrity range: -20°C to 110°C
- Free from RNase and DNase

## Use

- Applications: ideal for kit manufactures to allow flexible access to individual wells

## Options

- Sheet format: 148 x 98 mm, to fit all SBS footprint 96 well plates, designed to work with 96 Well Skirted PCR Plate for Removable 8 Well Tube Strips, Breakable Vertically PCR Plates, and Breakable Horizontally or Vertically plate ranges

## Ordering Information

4ti-0519

Double sided, re-sealable, adhesive film, with 96 holes and a protective liner, 100 sheets (148 x 98mm) per case

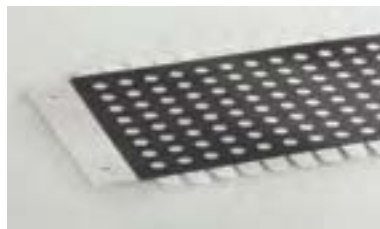

Seal Integrity  
Temperature Range

-20°C  
110°C



## Typical Molecular Diagnostic workflows – Example

### At the kit manufacturer

- The plate (e.g. 96 Well Skirted PCR Plate with Removable 8 Well Strips Frame loaded with 8 Well PCR Tube Strips, e.g. 4ti-0753/C/757) is filled with reagents on a robotic system
- The filled plate is sealed with a pierceable heat seal (e.g. Pierce Seal, 4ti-0530) resulting in lowest evaporation and best possible long-term storage (A)
- The protective Double Sided Re-Sealable Adhesive Film is placed on top of the pierceable seal to make sure there will be no damage of the seal during transportation (B)
- The sealed plate is cut into strips - the pre-filled strips are ready for transport, e.g. to the point of diagnostic use (C)

### At the point of diagnostic use

- The Double Sided Re-Sealable Adhesive Film protective layer is removed making the pierceable seal accessible (D)
- The sample is added to the pre-filled strip by piercing the seal (E)
- The strips can easily be resealed with foil or film strips by applying to the exposed black adhesive without the need for a heat sealer (F)
- After resealing, the strips are ready for PCR analysis

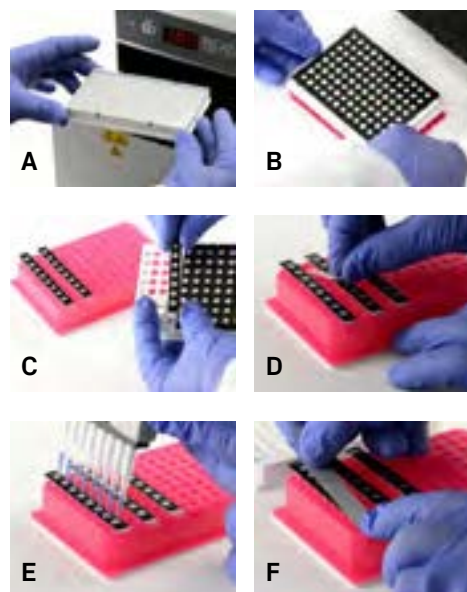

# Adhesive Seal Roller and Applicator

**Our Adhesive Seal Roller & Adhesive Seal Applicator ensure even pressure is applied across the adhesive seal for a complete application to the plate**

- To obtain the best sealing results when using our adhesive seals, we strongly recommend the use of the Adhesive Seal Roller (4ti-0502) or Adhesive Seal Applicator (4ti-0503)
- Both application tools ensure even pressure is applied across the adhesive seal for complete and secure application to your plate, across every well
- The handle of the Adhesive Seal Roller is made of a durable plastic, with a semi-hard padded rolling wheel
- The straight rigid sides of the small-sized Adhesive Seal Applicator allow for even pressure application
- When applying adhesive seals to 384 well plates, we recommend using the application tools in conjunction with our FrameStar 384 Holder (4ti-0391) to support the 384 well plates during seal applications, and to give a level base



4ti-0503

## Ordering Information

4ti-0502	<b>Adhesive Seal Roller;</b> ensures consistent seal application across all wells, 1 roller
4ti-0503	<b>Adhesive Seal Applicator;</b> ensures consistent seal application across all wells, 1 applicator



# Support Adapters to Improve Performance

## Optical Film Compression Pad

A silicone foam mat laminated to a non-stick PTFE film, to be used with adhesive seals, compatible with heated lid cyclers

- When used in conjunction with an adhesive seal - for instance the qPCR Seal (4ti-0560) - and a thermal cycler heated lid, the pad enhances the adhesion between the seal and the PCR plate
- This in turn improves results by reducing sample evaporation
- The 96 holes align with the wells of the PCR plate, ensuring the mat is compatible with qPCR instrumentation which image through the top of the well

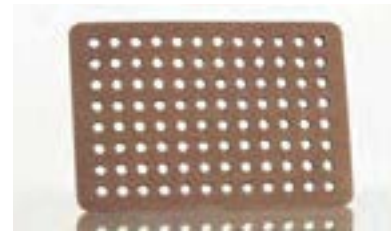

## Ordering Information

4ti-0563

Optical Film Compression Pad,  
5 pads per case

## Pierce Plate

Metal block with 96 pins, suitable for piercing every well of a heat or adhesive sealed 96 well plate

- This useful tool is a machine-engineered metal block with 96 pins aligned central to each well of a 96 well plate
- The pierce plate's 96 pins pierce every well of a heat or adhesive-sealed 96 well PCR or microplate (pierceable seals only)
- Enables instant access to samples with a single or multichannel pipette or automated system
- The Pierce Plate can be cleaned between uses to avoid contamination by using most cleaning agents that are suitable for use on aluminium e.g. RNase removal solutions, bleach or UV treatment



## Ordering Information

4ti-0398

Pierce Plate, metal block with 96 pins,  
suitable for piercing every well of a heat  
or adhesive sealed 96 well plate, 1 plate



**AZENTA**  
LIFE SCIENCES

## Adhesive Sealing Consumables Comparison Table

	Clear Seals			Foil Seals			Cross-cut Seals
<b>Name</b>	PCR Seal	Optically Clear Windowed qPCR Seal	qPCR Adhesive Seal	PCR Foil Seal	PCR Foil Seal Strong	DMSO Resistant Foil Seal	Pierceable Film Strong Adhesive, 96 Cross-Cut Windows
<b>Specifications</b>							
<b>Application</b>	PCR	qPCR, fluorescence 96-well microplates only	qPCR & other fluorescent applications Imaging techniques incl. crystallisation Plate readers, microscopy	PCR & sample storage Incubations	High temperature incubations & low temperature storage	Microplate sealing containing solvents incl. DMSO	Sample application or retrieval 96 well plates only
<b>Special Properties</b>	Good optical clarity	Discreet optical windows for 96-well plates	Good optical clarity	Irregular tearing when pierced prevents formation of vacuum	Strong adhesive	High solvent resistance	Cross-cut reduces tip or probe becoming clogged
<b>Seal Integrity Min Temperature</b>	-20°C	-20°C	-80°C	-40°C	-80°C	-20°C	-20°C
<b>Seal Integrity Max Temperature</b>	110°C	110°C	110°C	120°C	110°C	80°C	110°C
<b>Gas Permeability Rate</b>	N/A	N/A	N/A	N/A	N/A	N/A	N/A
<b>Moisture Vapor Transmission Rate</b>	N/A	N/A	N/A	N/A	N/A	N/A	N/A
<b>Gamma Irradiated</b>							
<b>Pierceable</b>				✓	✓		✓
<b>Peelable</b>	✓	✓	✓	✓	✓	✓	✓
<b>RNase/DNase free</b>	✓	✓	✓	✓	✓	✓	✓
<b>Product Codes</b>							
<b>Code</b>	4ti-0500	4ti-0565	4ti-0560	4ti-0550	4ti-0500FL	4ti-0512	4ti-0566
<b>Format</b>	Sheets	Sheets	Sheets	Sheets	Sheets	Sheets	Sheets
<b>Dimensions</b>	135 mm x 80 mm	133 mm x 76 mm	140 mm x 77 mm	130 mm x 80 mm	137 mm x 80 mm	122 mm x 80 mm	135 mm x 77 mm
<b>Code</b>	4ti-0500/8		4ti-0561				
<b>Format</b>	Perforated sheets		Roll				
<b>Dimensions</b>	115 mm x 100 mm		100 m x 80 mm				
<b>Code</b>	4ti-0500/12		4ti-0561/S				
<b>Format</b>	Perforated sheets		Sample roll				
<b>Dimensions</b>	137 mm x 71 mm		5 m x 80 mm				
<b>Code</b>	4ti-0500/HP		4ti-0560/HP				
<b>Format</b>	Half plate sheets		Half plate sheets				
<b>Dimensions</b>	70 mm x 80 mm		70 mm x 77 mm				

Cross-cut Seals	Permeable Seals				
Pierceable Film Strong Adhesive, 384 Cross-Cut Windows	Moisture Barrier Seal 24, 96, 384	Cell Culture Adhesive Seal	Microplate Seal Low Strength Adhesive Film	Double Sided Re-Sealable Adhesive Film	Name
					Specifications
Sample application or retrieval 384 well plates only	Eukaryotic cell culture, bacterial culture and long-term live assays Suitable for use on plate readers	Bacterial or cell culture	Aqueous sample storage	Diagnostic kit production	Application
Cross-cut reduces tip or probe becoming clogged Good solvent resistance, including DMSO	Gas permeable that allows air and CO <sub>2</sub> exchange, but prevents moisture evaporation Optically clear	Very low moisture transfer rate Suitable for bacterial or cell culture Air porosity: 10 sec/100 cc/in <sup>2</sup>	Medium strength transparent seal	Two sealing surfaces Optical windows	Special Properties
-80°C	-20°C	-20°C	-20°C	-20°C	Seal Integrity Min Temperature
120°C	80°C	80°C	80°C	110°C	Seal Integrity Max Temperature
N/A	0.6 m <sup>3</sup> /m <sup>2</sup> /day	8,900 m <sup>3</sup> /m <sup>2</sup> /day	N/A	N/A	Gas Permeability Rate
N/A	1 g/m <sup>2</sup> /day	4,200 g/m <sup>2</sup> /day	N/A	N/A	Moisture Vapor Transmission Rate
	✓	✓			Gamma Irradiated
✓	✓				Pierceable
✓	✓	✓	✓	✓	Peelable
✓	✓	✓	✓	✓	RNase/DNase free
					Product Codes
4ti-0566/384	4ti-0516/24	4ti-0517	4ti-0510	4ti-0519	Code
Sheets	Sheets	Sheets	Sheets	Sheets	Format
117 mm x 80 mm	140 mm x 80 mm	135 mm x 80 mm	130 mm x 80 mm	148 mm x 98 mm	Dimensions
	4ti-0516/96	4ti-0517/ST			Code
	Sheets	Sheets, gamma treated			Format
	137 mm x 80 mm	135 mm x 80 mm			Dimensions
	4ti-0516/384				Code
	Sheets				Format
	137 mm x 80 mm				Dimensions
					Code
					Format
					Dimensions





**AZENTA**  
LIFE SCIENCES

# Plate Lids, Caps & Mats



# Plate Lids, Caps & Mats



As an alternative to sealing films, Azenta offers multiple types of cap strips for sealing both plates and tubes - domed, flat, strips of 8, strips of 12, and our new optically superior caps.

A variety of rigid polystyrene lids are available for PCR plates and microplates, including lids compatible with our FrameStar<sup>®</sup> Optically Clear Tissue Culture Plate and Ultra Optically Clear Plate ranges. Azenta also stock silicone sealing mats for use with our storage plate ranges and in a variety of formats depending on the well size, number and shape.



# Strips of 8 & 12 Flat Sealing Caps

Clear polypropylene sealing caps, available as strips of 8 caps (domed or flat optical) and strips of 12 caps (flat optical)

- Compatible with our tube strips and 96 well PCR plates
- These strips are molded from virgin polypropylene in our UK-based Class 7 ISO certified clean-room production facility, and comply to the same stringent requirements as our FrameStar range

## Key Features

- Free from DNase, RNase, human genomic DNA, and endotoxin/pyrogen

## Use

- Flat caps are optically clear for fluorescence detection (e.g. qPCR)
- Easy to apply
- Large end tabs for easy removal
- Labeled for orientation

## Options

- Strips of 8 flat optical caps (4ti-0751/4ti-0783)\*: for use with our FrameStar PCR plates (including FrameStar Breakable Vertically PCR Plate), 8 Well PCR Tube Strip with PC Frame, 8 Well Removeable Tube Strips and general PCR plates, as well as with PCR tube strips (4ti-0781)
- Strips of 8 domed caps (4ti-0752/4ti-0782)\*: for use with our FrameStar PCR plates (including FrameStar Breakable Vertically PCR Plate), 8 Well PCR Tube Strip with PC Frame, 8 Well Removeable Tube Strips and general PCR plates, as well as with PCR tube strips (4ti-0781)
- Strips of 12 flat optical caps (4ti-0788): recommended for use with our 96 Well Non-Skirted PCR Plate Breakable Horizontally or Vertically and FrameStar Breakable Horizontally and Vertically PCR Plates to allow for flexible sample usage; not compatible with low profile plates



## Ordering Information

<b>4ti-0751</b>	<b>Strips of 8 Flat Optical Caps,</b> 300 strips per case
<b>4ti-0783</b>	<b>Strips of 8 Flat Optical Caps,</b> 125 strips per case
<b>4ti-0752</b>	<b>Strips of 8 Domed Caps,</b> 300 strips per case
<b>4ti-0782</b>	<b>Strips of 8 Domed Caps,</b> 125 strips per case
<b>4ti-0788</b>	<b>Strips of 12 Flat Optical Caps,</b> 200 strips per case <sup>1</sup>

<sup>1</sup> Recommended for use with our 96 Well Non-Skirted PCR Plate Breakable Horizontally or Vertically and FrameStar Breakable Horizontally and Vertically PCR Plates to allow for flexible sample usage; not compatible with low profile plates

# Strips of 8 Flat Optical Caps Crystal Clear

**Strips of 8 flat optical caps, crystal clear; designed for low volume applications such as low volume qPCR**

- With the Strips of 8 Flat Optical Caps Crystal Clear Azenta offers the perfect supplement to the existing range of PCR Cap Strips
- Due to their improved optical properties and evaporation-safe fit, the strips are ideally suited for applications where small volumes are used, e.g. low volume qPCR

## Key Features

- Made of a special polymer with improved optical properties leading to high transmission rates; ideally suited for small samples with low signal intensity
- Reduced shrinking during heating and cooling phases; very tight sealing
- Highest flexibility between the pitch of the individual caps
- Variations in the pitch of any 96 well plate are accommodated, the caps can easily be aligned to the corresponding tubes as they allow for more independent movement
- Free from DNase, RNase, human genomic DNA, and endotoxin/pyrogen

## Use

- For use with our FrameStar PCR plates (including FrameStar Breakable Vertically PCR Plate), 8 Well PCR Tube Strip with PC Frame and general PCR plates

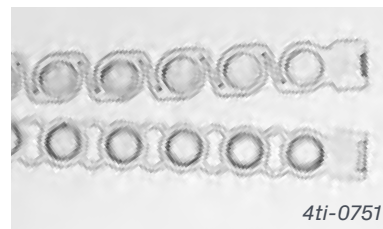

## Ordering Information

<b>4ti-0755</b>	<b>Strips of 8 Flat Optical Caps, crystal clear, 300 strips per case</b>
<b>4ti-0755/120</b>	<b>Strips of 8 Flat Optical Caps, crystal clear, 120 strips per case</b>

*For use with our our FrameStar PCR plates (including FrameStar Breakable Vertically PCR Plate), 8 Well PCR Tube Strip with PC Frame and general PCR plates*



**AZENTA**  
LIFE SCIENCES

# PCR Plate Lids, FrameStar Lids and Microplate Lids

Rigid polystyrene lids for PCR plates, optically clear tissue culture plates, and assay plates

- Designed to give a quick and easy sealing solution to protect samples from contamination and evaporation



4ti-0287



4ti-0289

## Ordering Information

### PCR Plate Lids & FrameStar Lids

4ti-0285	Ultra-Low Universal Lid, without condensation rings, clear, ultra-low profile, no cut corner, 100 lids per case
4ti-0288	PCR Plate Lid, without condensation rings, clear, low profile, cut corner H1, 50 lids per case
4ti-0287	FrameStar 96 Next Generation Sequencing Lid, with condensation rings, clear, low profile, cut corner H12, for use with 4ti-0960/RIG, 50 lids per case
4ti-0289	FrameStar 96 Lid, without condensation rings, clear, low profile, cut corner A12, for use with 4ti-0770, 50 lids per case

### Microplate Lids

4ti-0280	Microplate 384 Lid, without condensation rings, clear, low profile, cut corner A1/P1, 100 lids per case
4ti-0281	Microplate 384 Lid, gamma treated, without condensation rings, clear, low profile, cut corner A1/P1, 100 lids per case
4ti-0282	Microplate 96 Lid, with condensation rings, clear, low profile, cut corner A1/H1, 80 lids per case
4ti-0283	Microplate 96 Lid, gamma treated, with condensation rings, clear, low profile, cut corner A1/H1, 80 lids per case
4ti-0284	Microplate 24 Lid, with condensation rings, clear, low profile, cut corner A1, 80 lids per case
4ti-0286	Microplate 24 Lid, gamma treated, with condensation rings, clear, low profile, cut corner A1, 80 lids per case
4ti-0290	Universal Microplate Lid, without condensation rings, clear, low profile, no cut corner, 50 lids per case



# Auto-Sealing PCR Plate Lid

**Low profile, with integrated compression pad, white, no cut corner, for PCR applications on integrated instruments**

- Developed to support fully automated sealing in the absence of specific instrumentation
- Meets the needs of customers using integrated platforms that often lack suitable heat sealing instrumentation especially when low throughput is needed
- Specialized alternative to standard lids: while standard lids protect reagents, the Auto-Sealing PCR Lid helps minimize reagent evaporation during longer incubations
- Universal fit: due to the lack of cut corners, the lid can be applied to most plates, showing good sealing results when pushed down onto the plate

## Key Features

- Rigid polycarbonate frame padded with an elastic foam
- No cut corners
- Stackable

## Use

- Suitable for automation
- Universal fit to PCR plates
- Recommended when full sealing automation is required in the absence of dedicated instrumentation
- Suitable for low throughput workflows
- Alternative to heat sealing, when heat sealing materials and instrumentation are not an option
- Alternative to standard lids for longer incubations



## Specifications

Parameter	Value
Lid length	128.10 ± 0.10 mm
Lid width	85.80 ± 0.10 mm
Lid height	8.20 ± 0.05 mm

## Ordering Information

<b>4ti-0291</b>	Auto-Sealing PCR Plate Lid, with integrated compression pad, white, low profile, no cut corner, 20 lids per case
-----------------	--



# Sealing Cap Mats

**Silicone rubber or TPE mats, durable to high temperatures; for sealing storage plates to protect samples from evaporation**

- The clear cap mats are made of silicone rubber, a material that is highly durable to high temperatures, and so can be used to seal storage plates being used for high-temperature storage to protect samples from evaporation
- Azenta silicone mats are DNase/RNase and pyrogen-free to meet the highest standard of both laboratory experiment and clinical diagnostics
- All our clear silicone cap mats are pierceable

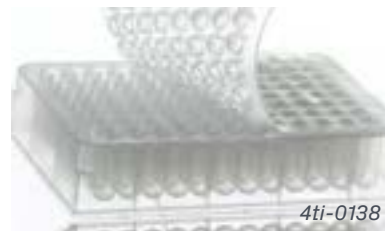

## Ordering Information

<b>4ti-0124</b>	<b>96 Round well Sealing Cap Mat</b> , clear silicone, for use with 4ti-0125, 50 mats per case
<b>4ti-0137</b>	<b>96 Square Well Sealing Cap Mat</b> , clear silicone, for use with square 96 well microplates and deep well storage microplates, 50 mats per case
<b>4ti-0138</b>	<b>96 Round Well Sealing Cap Mat</b> , clear silicone, for use with round 96 well microplates and deep well storage microplates (not for use with 4ti-0120 and 4ti-0110), 50 mats per case
<b>4ti-0139</b>	<b>384 Square Well Sealing Cap Mat</b> , clear silicone, for use with square 384 well microplates and deep well storage microplates, 50 mats per case
<b>4ti-0135</b>	<b>96 Round Well Sealing Cap Mat</b> , white silicone, for use with 4ti-0120 only, 100 mats per case



# Cap Mat for PCR Plates

**96 individual caps in sheet format, blue TPE, pierceable; suitable for sealing all of our 96 well PCR plates**

- These caps in sheet format are universally compatible with our 96 well PCR plates
- The caps can be individually applied and removed once detached from the backing liner, making the mats ideally suited for use with our flexible PCR consumables, including Individual Access and divisible plates
- The mats offer an alternative to adhesive and heat sealing, in particular as a temporary solution when samples need to be repeatedly accessed
- They are easily pierceable with pipette tips to access samples, and they are easily removable using 1- and 8-way decappers or, alternatively, using Azenta Automated Plate Seal Remover if a seal is overlaid on top of the caps

## Key Features

- Caps made from TPE mounted on an easily removable backing liner
- Pierceable with pipette tips

## Use

- Universal fit to 96 well PCR plates
- Ideally suitable for use with Individual Access and breakable PCR plates
- Applications: endpoint PCR, storage
- Not recommended for qPCR
- Alternative to adhesive and heat sealing, as temporary sealing solution when sample access must be carried out multiple times
- Caps perform equivalently to polypropylene cap strips during 25 cycle PCR
- The 96 caps can be applied all at once or individually
- The 96 caps can be removed all at once using Azenta Automated Plate Seal Remover (a seal must be placed on top of the caps), or individually using 1- or 8-way decappers



## Ordering Information

4ti-0778

Cap Mat for PCR Plates, 96 individual caps in sheet format, blue TPE, pierceable, 50 mats per case

# Custom Capabilities

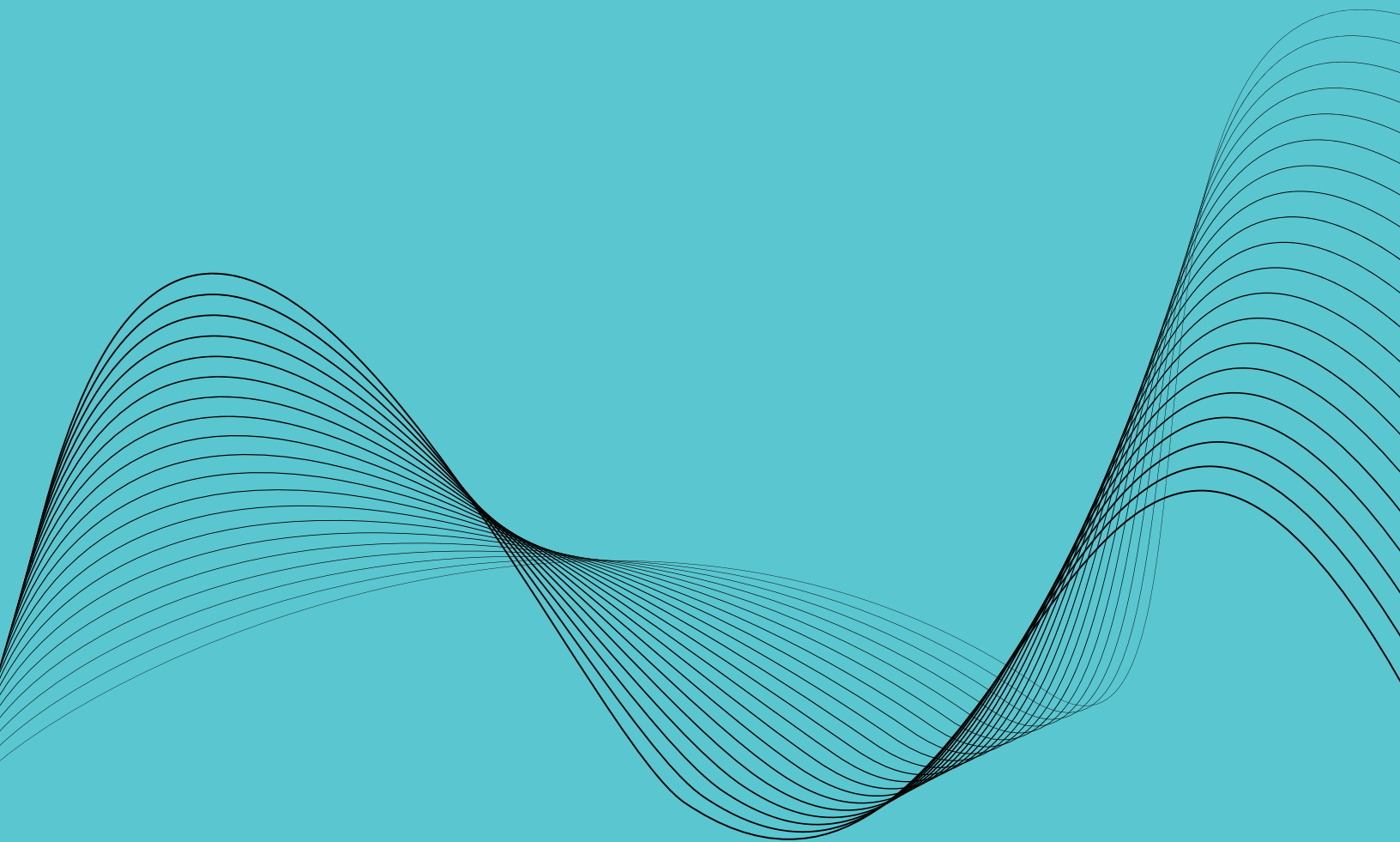

# Custom Capabilities for OEM Diagnostic Kit and Medical Device Manufacturing

Our team brings decades of development expertise to any custom project. Our experience in working with partners worldwide has placed us as the company of choice for introducing practical solutions to changing workflows, using innovative design and bespoke manufacture.

Our commitment to quality is reflected in our ISO certified management system which is applied at all levels, from manufacture, to technical support, to packaging and delivery of plates and seals.

Azenta has an integrated quality management system where plate and seal products undergo a wide range of QC inspections. We constantly perform visual, physical and biological tests to ensure both the absence of contaminants, as well as the integrity of the products. Our ISO 13485:2016 certification is an endorsement of our excellent manufacturing practices.

The ultimate quality of any product is dependent not only on the design of the component to be produced, but also the accuracy, construction and precision of the tooling and manufacturing processes.

Azenta's highly skilled engineers have extensive knowledge and experience in the design and manufacture of precision components for the life science industry.

By working with our in-house engineers we can offer a completely integrated project management service to ensure there is a smooth transition from initial project idea through to finished product. We aim to help enhance end products, reduce overall part and production costs, and streamline assembly within manufacturing. Whatever your custom requirement, you will receive ongoing support and advice from a designated sales contact, our QC department and Customer Services team.

We understand the costs and complexities involved with OEM products and would be happy to discuss a range of solutions for your project. Please contact us to discuss your specific requirements in detail and complete confidence.



## Custom and OEM Services Overview

- Product design and manufacturing for injection-molded parts
- Instrumentation design and manufacture: Heat sealers, press tools, cutters, liquid handling instrumentation
- Heat and adhesive sealing: Custom material design and manufacture
- Sample tracking solutions: Custom applications and specifications for linear and 2D coding
- Surface treatment options
- Gamma treatment options
- Packaging choices
- Specified QC procedures



# Customizable PCR Plates, Microplates and Seals

We partner with our customers to provide flexible solutions that improve reproducibility and achieve consistent results. We can provide the complete end-to-end development of custom, premium plastic consumables including PCR plates, strips and tubes, sealing materials and instrumentation. Our completely tailored solutions include custom designs, tool making and contract manufacturing from concept to completion.

## Plates, Strips, and Tubes



### Customizable options:

- Non-SBS format
- Plate color
- Well color, including clear wells and white wells
- Application specific direct marking and branding options
- Coating
- Treatments
- 2D coding and barcoding for tracking of samples

## Plate Seals

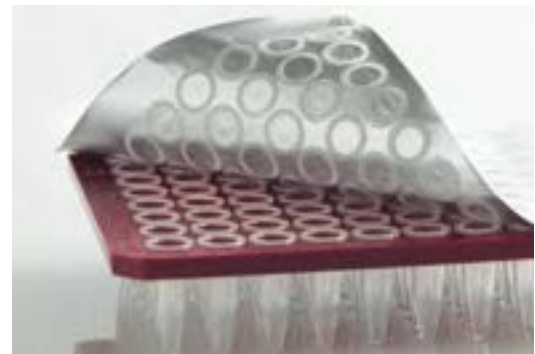

### Customizable options:

- Non-standard size seals, in rolls or sheets
- Application specific direct marking and branding options
- Custom instrumentation to support your workflows
- Material
- Chemical Compatibility

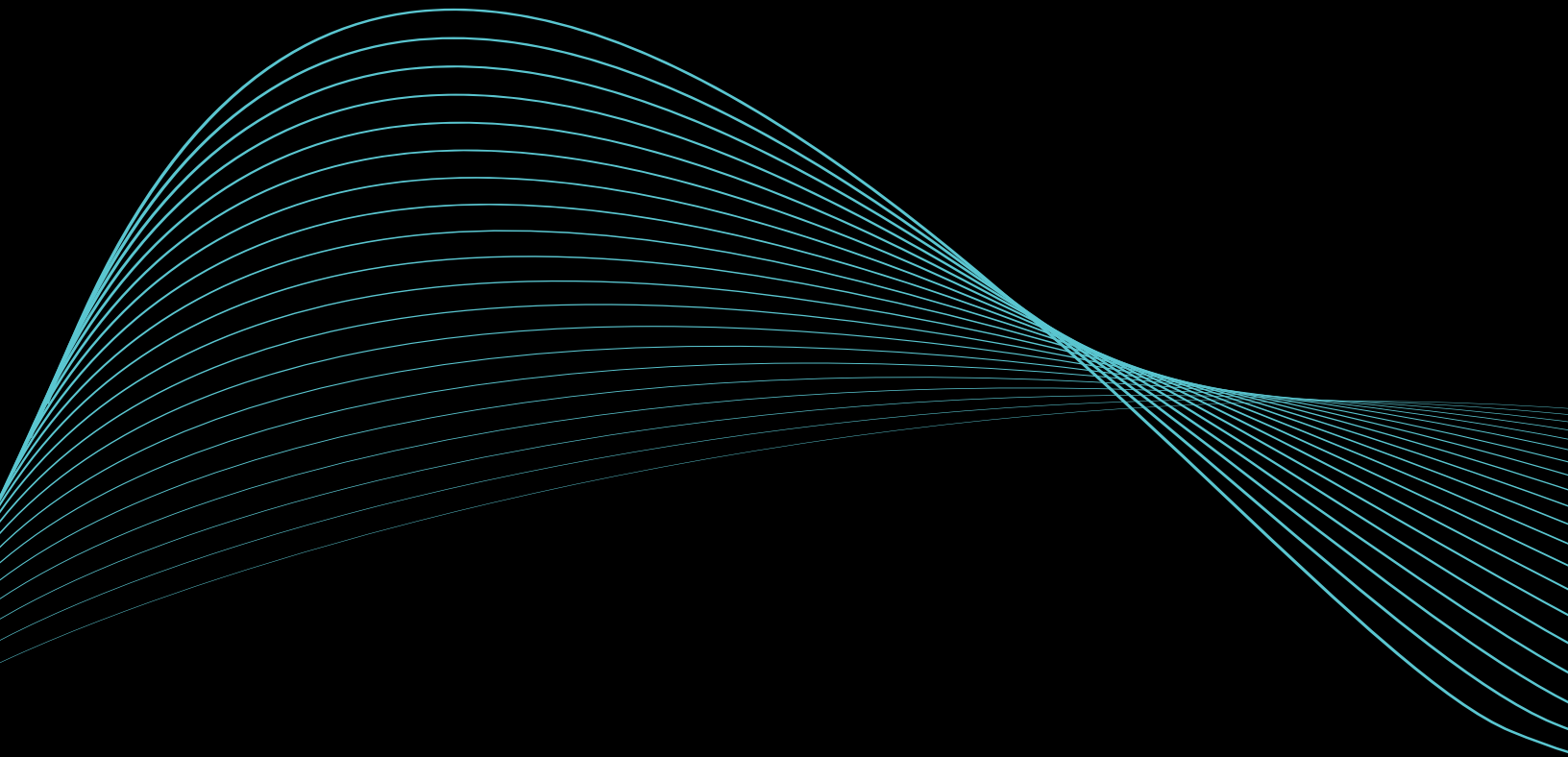

**AZENTA**  
LIFE SCIENCES

# Sample Cooling and Heating



# Sample Cooling and Heating Standardization



**Prepare.**

## Ice-free sample cooling and freezing

- Consistent and reproducible
- Ideal for working in a hood



*Thermoconductive Tube Rack and Ice-Free Cooling Workstation systems*



**Protect.**

## Controlled-rate cell freezing

- No alcohol
- High post-thaw recovery and viability
- Proven for stem cells, primary cells, PBMC, cell lines and more



*Alcohol Free Cell Freezing Containers*



**Preserve.**

## Archival storage integrity

- Hinged lid helps box and lid stay together
- LN<sub>2</sub> drain holes and water proof fiberboard



*Hinged CryoBoxes*



**AZENTA**  
LIFE SCIENCES

# Alcohol-Free Cell Freezing Containers





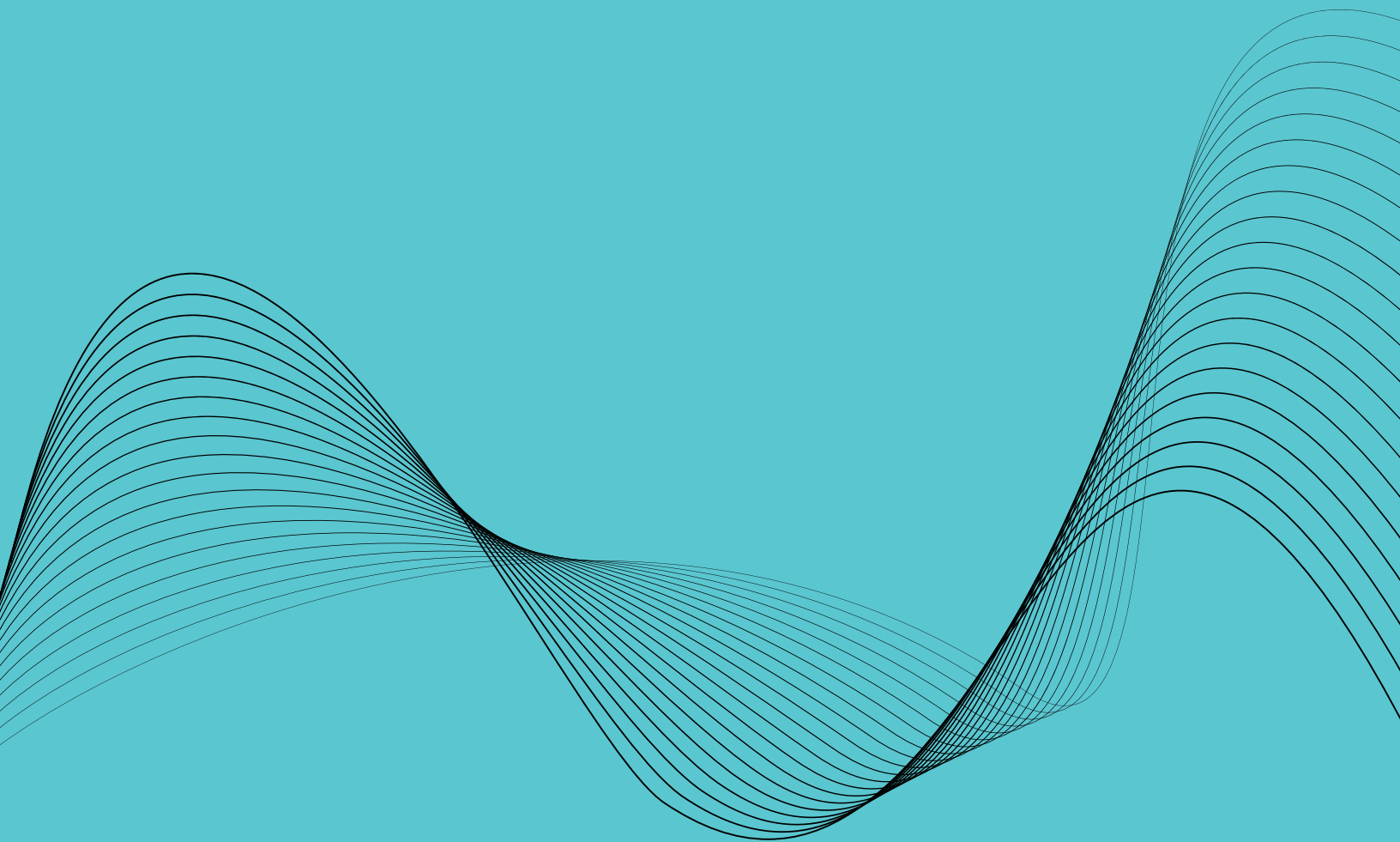

**AZENTA**  
LIFE SCIENCES

# Alcohol-Free Cell Freezing Containers

**Alcohol-free cell freezing containers** ensure standardized controlled-rate  $-1^{\circ}\text{C}/\text{minute}$  cell freezing in a  $-80^{\circ}\text{C}$  freezer - without alcohol or any fluids. Proven for use with a variety of cell types including stem cells, primary cells, PBMC cell lines, insect cells, yeast and others. The Alcohol-Free Cell Freezing technology utilizes a thermo-conductive alloy core and highly-insulative outer material to control the rate of heat removal and provide reproducible cell cryopreservation. Alcohol-Free Cell Freezing units are easy to use and deliver comparable results to expensive programmable freezers.

**Alcohol-free cell freezing containers are proven to work with many cell types including:**

## Stem Cells

- Human Embryonic Stem
- Preadipocytes
- Breast Cancer Stem
- Colon Cancer Stem
- Glioblastoma Stem
- Mouse Embryonic Stem
- Human Endothelial
- Progenitor

## Primary Cells

- Neonatal Keratinocytes
- Human WBCs
- Mouse
- WBCs
- Human CD34+
- Muscle
- Human Tendon
- Fibroblasts
- Melanoma Tumor
- Human Cardiac
- Ventricular
- Human Cardiac Atrial

## Cell Lines

- CHO
- LnCap
- HTB77
- A549
- HeLa



**Cell Freezing Containers**, in combination with a  $-80^{\circ}\text{C}$  freezer, will provide the freezing rate of  $-1^{\circ}\text{C}/\text{minute}$  that is ideal for cryopreservation of most cells and cell lines. Using a combination of uniform-density cross-linked polyethylene foam, a solid state core, and radial vial symmetry, freezing profiles are consistent and reproducible. It is important to fully load Cell Freezing Containers prior to freezing. Foam is non-absorbent and will impose negligible change in the freezer environment; thereby protecting nearby frozen samples. The low heat content also ensures that Cell Freezing Containers will rapidly return to room temperature when removed from the freezer.



Alcohol-free cell freezing containers	Isopropanol (IPA) Container
<b>No alcohol</b> <ul style="list-style-type: none"> <li>• No fluids</li> <li>• No pre-cooling</li> <li>• Saves 12L/unit of IPA per year</li> </ul>	<b>Requires isopropanol</b> <ul style="list-style-type: none"> <li>• Replace alcohol every 5 uses</li> <li>• Track number of uses</li> <li>• Pre-cool alcohol in refrigerator</li> </ul>
<b>No variability</b> <ul style="list-style-type: none"> <li>• All vials have uniform freeze rate</li> <li>• Radially symmetric design ensures vial consistency</li> </ul>	<b>Inconsistent freeze rate</b> <ul style="list-style-type: none"> <li>• Alcohol degradation induces variability</li> <li>• Two circles of wells; two freeze rates</li> </ul>
<b>No on-going cost</b> <ul style="list-style-type: none"> <li>• No alcohol purchase or disposal</li> </ul>	<b>Approximately \$350/year</b> <ul style="list-style-type: none"> <li>• Change alcohol weekly</li> <li>• Dispose of hazardous waste</li> </ul>
<b>No stuck lids</b> <ul style="list-style-type: none"> <li>• Ergonomic lid comes off easily when frozen</li> <li>• Not cold to the touch when removing from the <math>-80^{\circ}\text{C}</math> freezer</li> </ul>	<b>Difficult to handle and open</b> <ul style="list-style-type: none"> <li>• Screw cap difficult to remove when frozen</li> <li>• Frozen unit is slippery and cold to touch</li> </ul>
<b>Quick re-use time</b> <ul style="list-style-type: none"> <li>• Ready to use again after five minutes</li> </ul>	<b>Wait between runs</b> <ul style="list-style-type: none"> <li>• Takes <math>&gt;1</math> hr for alcohol to warm-up</li> </ul>

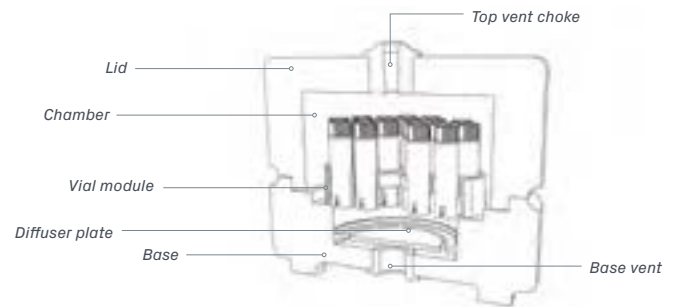

**Cell Freezing Containers for 30 x 1mL or 2mL Cryo Tubes** utilize a solid state core and controlled micro-convection technology to evenly draw in  $-80^{\circ}\text{C}$  freezer air through a bottom base vent, uniformly disperse the cold air around each vial in the central chamber and then release the thermal load from the vials through a top vent choke. The inner vial module holds 30 cryogenic vials and can be removed in one step. Each vial achieves a uniform and reproducible  $-1^{\circ}\text{C}/\text{minute}$  freezing profile and thermal profiles are highly reproducible. Due to the low thermal mass of the uniform-density cross-linked polyethylene foam container, freezing can be conducted without a rise in local freezer temperature, thereby protecting nearby samples.



# Alcohol-Free Cell Freezing Containers

## Alcohol-Free Cell Freezing Container Reproducibility

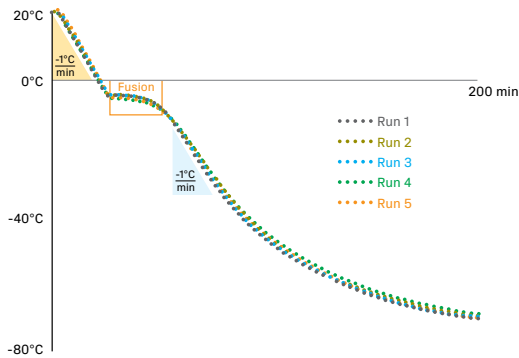

**Performance test:** A temperature probe was placed into a 2.0 mL cryogenic vial containing 1.0 mL of water and the tube was inserted into a room temperature Alcohol-Free Cell Freezing Container. The container was placed into a -80°C freezer and the temperature rate and profile was recorded over a 3 hour period. The test was repeated 5 consecutive times. **Conclusion:** The Alcohol-Free Cell Freezing Container generated identical fusion time and cooling profiles over five consecutive freeze cycles.

## Alcohol-Free Cell Freezing Container Performance vs. IPA Container

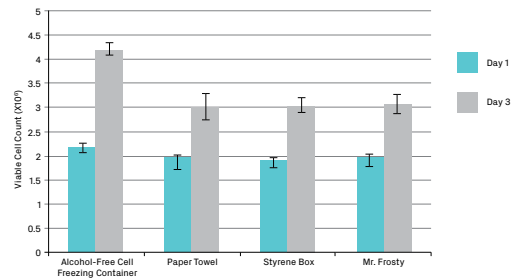

**Human embryonic stem cells, RC-10** were frozen using the technique indicated, thawed after 2 weeks in LN<sub>2</sub>, and counted immediately (Day 1) or after 3 days of growth (Day 3).

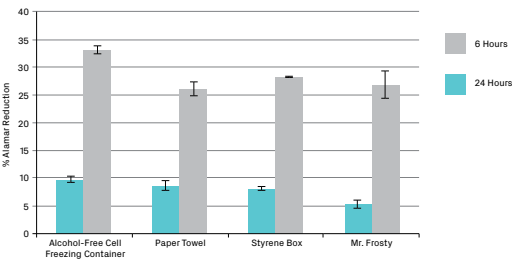

Alamar blue reduction assay for proliferation assessment showed cells frozen in an Alcohol-Free Cell Freezing Container grew more quickly, leading to more total cells.

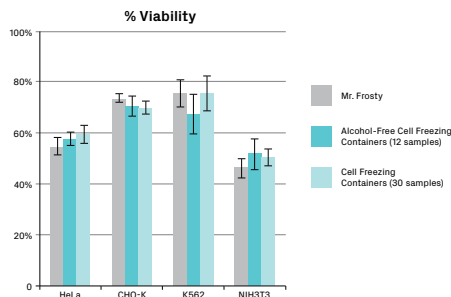

**HeLa, CHO-K, K562, NIH3T3.** 12-well Alcohol-Free 30-well Cell Freezing Containers, Cell Freezing Containers or “Mr. Frosty” freezing containers were used to freeze all four cell lines. Identical transfection efficiencies and viabilities were observed after thawing.

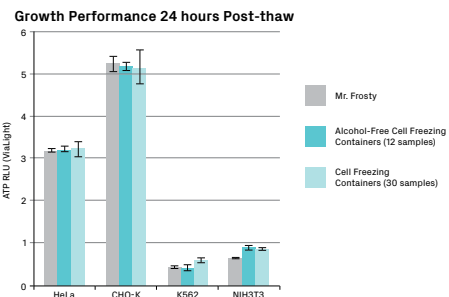

Identical growth of cells was observed 24 hours post-thaw.

## Alcohol-Free Cell Freezing Container Protocols



### Cryopreservation and Thawing of Cells

Wayne M. Yokoyama, Maria L. Thompson, Rolf O. Ehrhardt  
University of California School of Medicine, San Francisco, CA BioCision LLC, Larkspur, California  
Curr. Protoc. Immunology. 2012 Nov; 99 Appendix 3G



### Standardized Cryopreservation of Pluripotent Stem Cells

Rick I. Cohen, Maria L. Thompson, Brian Schryver, Rolf O. Ehrhardt  
Rutgers University, Piscataway, New Jersey  
BioCision LLC, San Rafael, California  
Curr. Protoc. Stem Cell Biol. 28:1C.14.1-1C.14.10



### Standardized Cryopreservation of Human Primary Cells

Thomas V. Ramos, Aby J. Mathew, Maria L. Thompson, Rolf O. Ehrhardt  
HemaCare Corporation, Van Nuys, California, BioLife Solutions, Bothell, Washington, BioCision, Larkspur, California  
Curr. Protoc. Cell Biology. 2014 Sept; 64 Appendix 3I.

## Alcohol-Free Cell Freezing Containers

### Alcohol-Free Cell Freezing Container Performance vs. Programmable Freezer

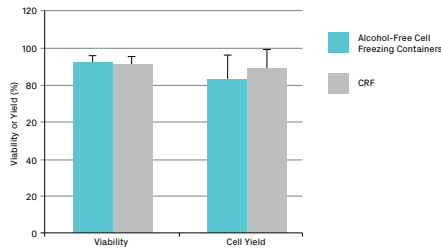

**Ag-Tregs.** Effects of freezing on antigen-specific Treg (Ag-Treg) cell therapy products; Ag-Tregs (n = 6) were frozen at concentration of 1 to 10 x 10<sup>6</sup> cells/mL using the Alcohol-Free Cell freezing Container or controlled-rate freezer (CRF) with a freezing rate of -1°C/min. Viability and absolute viable cell count of thawed Ag-Treg cell therapy products were evaluated by flow cytometry. - *Data generated by TxCell SA*

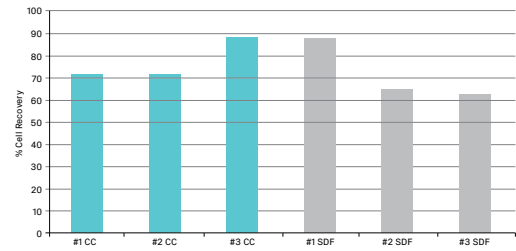

Comparison of freezing methods. Graph comparing % of cell recovery after freezing with the Alcohol-Free Cell Freezing Container (blue) versus freezing using a programmable step-down freezer (gray) in 3 different samples at high cell concentration. There was no significant difference between the two freezing methods. - *Data performed by UCSF Diabetes Center*

## For 1.0 mL or 2.0 mL Cryogenic Vials



### Cell Freezing Containers for 12 x 1mL 96-format Sample Tubes

For 12 standard 1mL storage tubes. 0.5mL to 1mL fill per vial. Optimized for freezing 1mL 96-format sample tubes. Radially symmetric for uniform freezing. Numbered wells for easy identification. Beveled lid for secure gripping and easy opening.



### Cell Freezing Containers for 12 x 1mL or 2mL Cryo Tubes

For 12 standard 1.0 mL to 2.0 mL cryogenic vials, 1.0 mL fill per vial. Radially symmetric for uniform vial freezing. Numbered wells for easy sample identification. Beveled lid for secure gripping and easy opening. Exposed vial tops when lid is open for quick, organized removal of frozen samples.

## Ordering Information

<b>BCS-407P</b>	Cell Freezing Container, for 12 x 1ml 96-format sample tubes, <b>purple</b>
<b>BCS-407O</b>	Cell Freezing Container, for 12 x 1ml 96-format sample tubes, <b>orange</b>

## Ordering Information

<b>BCS-405</b>	Cell Freezing Container, for 12 x 1ml or 2ml cryo tubes, <b>purple</b>
<b>BCS-405G</b>	Cell Freezing Container, for 12 x 1ml or 2ml cryo tubes, <b>green</b>
<b>BCS-405O</b>	Cell Freezing Container, for 12 x 1ml or 2ml cryo tubes, <b>orange</b>
<b>BCS-405PK</b>	Cell Freezing Container, for 12 x 1ml or 2ml cryo tubes, <b>pink</b>
<b>BCS-405MC</b>	Cell Freezing Container, for 12 x 1ml or 2ml cryo tubes, multipack with <b>4 colors</b> - purple, green, orange and pink

## Alcohol-Free Cell Freezing Containers

### For 3.5 mL to 5.0 mL Cryogenic Vials



#### Cell Freezing Containers for 12 x 3.5mL to 5mL Cryo Tubes

For 12 standard 3.5 mL to 5.0 mL fill cryogenic vials, 3.5 to 5.0 mL fill per vial. Radially symmetric for uniform vial freezing. Numbered wells for easy sample identification. Beveled lid for secure gripping and easy opening. Exposed vial tops when lid is open for quick, organized removal of frozen samples.

### Ordering Information

<b>BCS-406</b>	Cell Freezing Container, for 12 x 3.5ml to 5ml cryo tubes, <b>purple</b>
----------------	--



#### Cell Freezing Containers for 30 x 1mL or 2mL Cryo Tubes

For 30 standard 1.0 mL to 2.0 mL cryogenic vials, 1.0 mL fill per vial. Controlled micro-convection for uniform freezing of 30 vials. Removable vial tray for one-step transfer of samples into and out of freezing chamber.

### Ordering Information

<b>BCS-170</b>	Cell Freezing Container, for 30 x 1ml or 2ml cryo tubes, <b>purple</b>
<b>BCS-170G</b>	Cell Freezing Container, for 30 x 1ml or 2ml cryo tubes, <b>green</b>
<b>BCS-170O</b>	Cell Freezing Container, for 30 x 1ml or 2ml cryo tubes, <b>orange</b>
<b>BCS-170PK</b>	Cell Freezing Container, for 30 x 1ml or 2ml cryo tubes, <b>pink</b>

### For Injectable Cell Therapy Ampules

#### Cell Freezing Containers for 12 x 2mL Injectable Cell Therapy Ampules and Cell Freezing Containers for 6 x 10mL Injectable Cell Therapy Ampules

For 12 standard 2.0 mL injectable ampules, 1.0 mL fill per ampule (Cell Freezing Containers for 12 x 2mL Injectable Cell Therapy Ampules). For 6 standard 10.0 mL injectable ampules, 5.0 mL fill per ampule (Cell Freezing Containers for 6 x 10mL Injectable Cell Therapy Ampules). Radially symmetric for uniform freezing of injectable ampules. Easy open lid. Exposed vial tops when lid is open for quick, organized removal of frozen samples.



### Ordering Information

<b>BCS-172</b>	Cell Freezing Container, for 12 x 2ml injectable cell therapy ampules, <b>purple</b>
<b>BCS-262</b>	Cell Freezing Container, for 6 x 10ml injectable cell therapy ampules, <b>purple</b>

## Cell Cryopreservation Systems



**Cell Freezing Containers for 12 x 2mL Injectable Cell Therapy Ampules Stem Cell Cryopreservation System**

### Ordering Information

<b>BCS-172CS</b>	<b>Stem Cell Cryopreservation System</b> , containing 1 x Cell Freezing Container, for 12 x 2ml injectable cell therapy ampules, purple and 1 x Thermoconductive Tube Rack, holds 12 x 2ml injectable cell therapy ampules, cylindrical wells, <b>gray</b>
------------------	--



**Cell Freezing Containers for 6 x 10mL Injectable Cell Therapy Ampules Stem Cell Cryopreservation System**

### Ordering Information

<b>BCS-262CS</b>	<b>Stem Cell Cryopreservation System</b> , containing 1 x Cell Freezing Container, for 6 x 10ml injectable cell therapy ampules, purple and 1 x Thermoconductive Tube Rack, holds 12 x 10ml injectable cell therapy ampules, cylindrical wells, <b>gray</b>
------------------	---



*Note: For optimal freezing it is important to fully load each Cell Freezing Container prior to freezing. Cell Freezing Container Filler Vials are recommended for filling any empty wells.*

### Cell Freezing Container Filler Vials

To ensure cell freezing rate consistency and uniform results when using Azenta containers, insert a Cell Freezing Container Filler Vial into empty wells when freezing less than a full load. Suitable for repeated use and compatible with Cell Freezing Containers for 12 x 1mL or 2mL Cryo Tubes, Cell Freezing Containers for 30 x 1mL or 2mL Cryo Tubes and Cell Freezing Containers for 12 x 3.5mL to 5mL Cryo Tubes containers. 6 per pack.

### Ordering Information

<b>BCS-3105</b>	<b>Cell Freezing Container Filler Vials</b> , 6 x 2ml
<b>BCS-3106</b>	<b>Cell Freezing Container Filler Vials</b> , 6 x 5ml
<b>BCS-3107</b>	<b>Cell Freezing Container Filler Vials</b> , 6 x 1mL



### Cell Freezing Container Vial Module for 30 x 1ml or 2ml Cryo Tubes

Cell Freezing Container Vial Module for 30 x 1ml or 2ml Cryo Tubes is a holder for 30 1.0 mL or 2.0 mL cryogenic vials that allows one-step insertion and removal of all 30 vials at once. Fits into a standard 5.0 x 5.0 x 2.0 inch cryostorage box. Compatible with dry ice and liquid nitrogen.

### Ordering Information

<b>BCS-210</b>	<b>Removable Cryo Tube Module</b> for use with the Cell Freezing Container for 30 x 1mL or 2ml Cryo Tubes
----------------	---



# Ice-Free Cooling Workstations





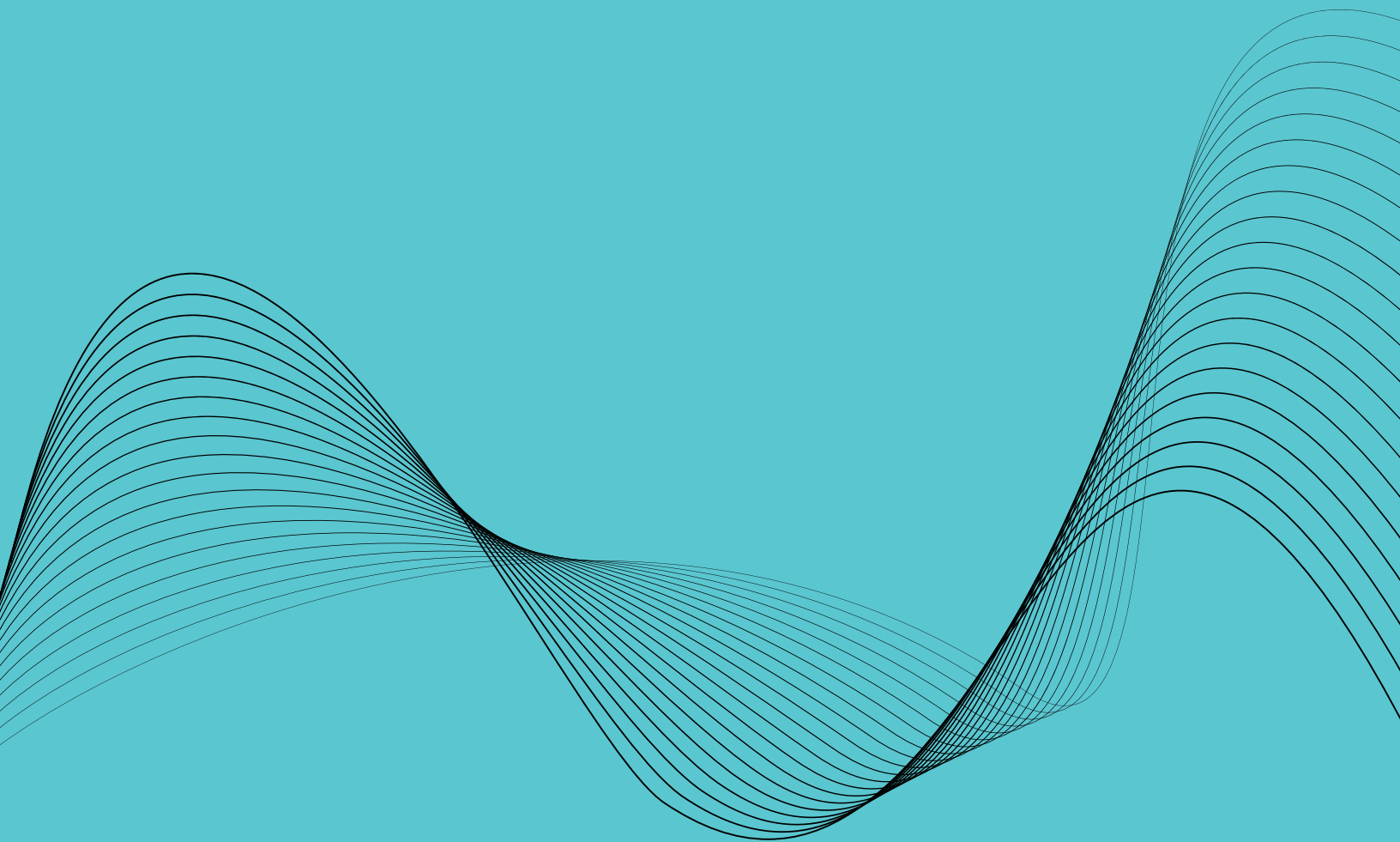

**AZENTA**  
LIFE SCIENCES

# Ice-Free Cooling Workstations



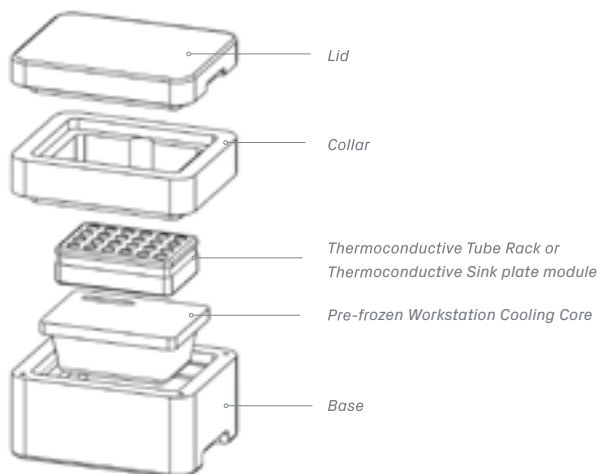



**Ice-Free Cooling Workstations** are bench top cooling workstations that provide sample cooling or freezing without ice, electricity or batteries. Ice-Free Cooling Workstations are versatile and accommodate a variety of sample formats and temperatures. The modular design enables the use of Thermoconductive Tube Rack and Thermoconductive Sink sample modules to hold microfuge tubes, cryogenic vials, PCR tubes or plates, assay plates and more.



## How It Works

- Freeze the Cooling Core in  $-20^{\circ}\text{C}$  freezer
- Place frozen core in base
- Place Thermoconductive Tube Rack or Thermoconductive Sink module on core
- Module will equilibrate and maintain temperature via thermo-conductivity

## How to Configure an Ice-Free Cooling Workstation System

	1. Identify Tube or Plate	2. Choose Thermoconductive Tube Rack or Thermoconductive Sink Module	3. Choose Ice-Free Cooling Workstation capacity and color
<b>Example 1</b>	up to 24 microcentrifuge tubes	 Thermoconductive Tube Rack for 24 Microcentrifuge Tubes	 Cooling Workstation, Single Capacity
<b>Example 2</b>	up to 48 microcentrifuge tubes	 2 x Thermoconductive Tube Racks for 24 Microcentrifuge Tubes	 Cooling Workstation, Double Capacity
<b>Example 3</b>	24 microcentrifuge tubes and one PCR plate, 12 PCR strips, or 0.2 mL PCR tubes	 Thermoconductive Tube Rack for 24 Microcentrifuge Tubes + Thermoconductive Tube Rack for 96-Well PCR Plates	 Cooling Workstation, Double Capacity



## Choose Your Thermoconductive Tube Rack Module

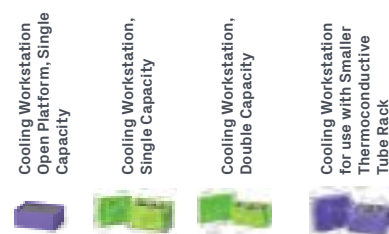

Open	4 hr	10 hr	10 hr	4 hr
Closed	--	16 hr	16 hr	10 hr

For Use With	Wells	Well Shape	Dimensions (L x W x H)	Well Dia.	Well Depth	Description	Item No.	Capacity			
<b>Microfuge tube modules: Thermoconductive Tube Racks for Microcentrifuge Tubes</b>											
1.5 mL or 2.0 mL tubes	6	Cylindrical	6.0 x 4.3 x 3.8 cm	11.1 mm	32.7 mm	Thermoconductive Tube Rack for 6 Microcentrifuge Tubes	BCS-163	1	up to 3	up to 8	up to 2
1.5 mL or 2.0 mL tubes	15	Cylindrical	10.2 x 6.4 x 3.8 cm	11.1 mm	32.7 mm	Thermoconductive Tube Rack for 15 Microcentrifuge Tubes	BCS-125	1	1	up to 4	1
1.5 mL conical tubes	15	Conical	10.2 x 6.4 x 3.8 cm	11.1 mm	35.3 mm	Thermoconductive Tube Rack for 15 Microcentrifuge Tubes, Conical Wells	BCS-127	1	1	up to 4	1
1.5 mL Or 2.0 mL tubes	24	Cylindrical	12.8 x 8.5 x 3.8 cm	11.1 mm	32.7 mm	Thermoconductive Tube Rack for 24 Microcentrifuge Tubes*	BCS-535	1	1	up to 2	—
5.0 mL centrifuge tubes	12	Conical	12.7 x 8.6 x 5.0 cm	16.5 mm	48.7 mm	Thermoconductive Tube Rack for 12 x 5mL Microcentrifuge Tubes*	BCS-539	1	1	up to 2	—
1.5 mL or 2.0 mL tubes	30	Cylindrical	12.0 x 10.2 x 3.8 cm	11.1 mm	32.7 mm	Thermoconductive Tube Rack for 30 Microcentrifuge Tubes	BCS-108	1	--	up to 2	1
1.5 mL conical tubes	30	Conical	12.0 x 10.2 x 3.8 cm	11.1 mm	35.3 mm	Thermoconductive Tube Rack for 30 Microcentrifuge Tubes, Conical Wells	BCS-128	1	--	up to 2	1
500 uL conical tubes	30	Conical	12.0 x 10.2 x 3.8 cm	11.1 mm	35.3 mm	Thermoconductive Tube Rack for 30 Microcentrifuge Tubes, 500µl	BCS-137	1	--	up to 2	1
<b>Cryogenic vial and FACS tube modules: Thermoconductive Tube Racks for Cryo or FACS Tubes</b>											
cryogenic vials or FACS tubes	15	Cylindrical	10.2 x 6.4 x 3.8 cm	12.7 mm	32.7 mm	Thermoconductive Tube Rack for 15 Cryo or FACS Tubes	BCS-126	1	1	up to 4	1
cryogenic vials or FACS tubes	24	Cylindrical	12.8 x 8.5 x 3.8 cm	12.7 mm	32.7 mm	Thermoconductive Tube Rack for 24 Cryo or FACS Tubes*	BCS-534	1	1	up to 2	—
cryogenic vials or FACS tubes	30	Cylindrical	12.0 x 10.2 x 3.8 cm	12.7 mm	32.7 mm	Thermoconductive Tube Rack for 30 Cryo or FACS Tubes <sup>ø</sup>	BCS-138	1	--	up to 2	1
cryogenic vials or FACS tubes	45	Cylindrical	17.3 x 9.7 x 3.8 cm	12.7 mm	32.7 mm	Thermoconductive Tube Rack for 45 Cryo or FACS Tubes	BCS-105	--	--	1	—
<b>PCR plate, strip well or tube modules: Thermoconductive Tube Racks for PCR Plates</b>											
One 96-well PCR plate, strip wells, 0.2mL tubes	96	Tapered	12.7 x 8.6 x 2.5 cm	-	13.2 mm	Thermoconductive Tube for 96-Well PCR Plates*	BCS-529	1	1	up to 2	—
6 strip wells and 12 x 1.5 or 2.0 mL microfuge tubes	48(PCR) 12(M)	Tapered(PCR) Cylindrical(M)	12.7 x 8.6 x 3.8 cm	- 11.1 mm	13.2 mm 32.7 mm	Thermoconductive Tube Rack for Microcentrifuge Tubes Plus Strip Wells*	BCS-523	1	1	up to 2	—
One 384-well PCR plate	384	Tapered	12.7 x 8.6 x 1.9 cm	-	7.6 mm	Thermoconductive Tube Rack for 384-Well PCR Plates*	BCS-538	1	1	up to 2	—
<b>2D coded storage tube modules: Thermoconductive Tube Racks for 96-Well Coded Tubes</b>											
0.5 mL 2D storage tubes	96	Cylindrical	13.1 x 8.9 x 3.6 cm	8.4 mm	24.6 mm	Thermoconductive Tube Rack for 96 x 0.5mL Barcoded Tubes	BCS-231	1	1	up to 2	—
1.4 mL 2D storage tubes	96	Cylindrical	13.2 x 8.9 x 3.6 cm	8.3 mm	32.7 mm	Thermoconductive Tube Rack for 96 x 1mL Barcoded Tubes	BCS-149	1	1	up to 2	—
<b>Cell therapy injectable ampule modules: Thermoconductive Tube Racks for Injectable Cell Therapy Ampules</b>											
2.0 mL injectable cell therapy ampules	12	Cylindrical	12.7 x 8.6 x 3.8 cm	16.0 mm	24.0 mm	Thermoconductive Tube Rack for 12 x 2mL Injectable Cell Therapy Ampules	BCS-266	1	1	up to 2	—
10.0 mL injectable cell therapy ampules	12	Cylindrical	12.7 x 8.6 x 3.8 cm	23.6 mm	27.9 mm	Thermoconductive Tube Rack for 12 x 10mL Injectable Cell Therapy Ampules	BCS-265	1	1	up to 2	—

\* SBS-compatible ø "gripping" wells for one-hand vial opening/closing

## Ice-Free Cooling Workstations

For Use With	Wells	Well Shape	Dimensions (L x W x H)	Well Dia.	Well Depth	Description	Item No.	Capacity			
<b>Tall tube modules: Thermoconductive Tube Racks for 15 mL, 50mL and 250 mL Centrifuge Tubes</b>											
15 mL centrifuge tubes	12	Cylindrical	13.7 x 9.5 x 11.8 cm	17.5 mm	105.4 mm	Thermoconductive Tube Rack for 12 x 15mL Centrifuge Tubes, with insulative exterior†	BCS-232	1	1 <sup>Δ</sup>	up to 2 <sup>Δ</sup>	—
15 mL centrifuge tubes	9	Cylindrical	8.9 x 8.9 x 10.7 cm	17.1 mm	106.7 mm	Thermoconductive Tube Rack for 9 x 15mL Centrifuge Tubes	BCS-153	1	1 <sup>Δ</sup>	up to 2 <sup>Δ</sup>	—
50 mL centrifuge tubes	4	Cylindrical	8.9 x 8.9 x 10.7 cm	29.5 mm	101.6 mm	Thermoconductive Tube Rack for 4 x 50mL Centrifuge Tubes	BCS-154	1	1 <sup>Δ</sup>	up to 2 <sup>Δ</sup>	—
250 mL centrifuge tube	1	Conical	8.9 x 8.9 x 14.0 cm	60.4 mm	133.3 mm	Thermoconductive Tube Rack for 1 x 250mL Centrifuge Tube	BCS-532	1	1 <sup>**</sup>	up to 2 <sup>**</sup>	—
250 mL centrifuge tube	1	Cylindrical	8.9 x 8.9 x 7.2 cm	73.6 mm	66. mm	n/a	BCS-533	1	1	up to 2	—
<b>Blood collection tube modules: Thermoconductive Tube Racks for Blood Tubes</b>											
13 mm or 16 mm blood tubes	12	Cylindrical	13.7 x 9.5 x 9.6 cm	16.6 mm	83.3 mm	Thermoconductive Tube Rack for 12 x 13mm or 16mm Blood Tubes, with insulative exterior†	BCS-235	1	1	up to 2 <sup>Δ</sup>	—
13x75 mm blood tubes	9	Cylindrical	8.9 x 8.9 x 6.1 cm	13.0 mm	61.0 mm	Thermoconductive Tube Rack for 9 13x75mm Blood Tubes	BCS-157	1	1 <sup>Δ</sup>	up to 2 <sup>Δ</sup>	—
13x100 mm blood tubes or 5 mL cryogenic vials	9	Cylindrical	8.9 x 8.9 x 8.4 cm	13.0 mm	83.8 mm	Thermoconductive Tube Rack for 9 13x100mm Blood Tubes	BCS-155	1	1 <sup>Δ</sup>	up to 2 <sup>Δ</sup>	—
16x100 mm blood tubes	9	Cylindrical	8.9 x 8.9 x 8.4 cm	16.0 mm	83.8 mm	Thermoconductive Tube Rack for 9 16x100mm Blood Tubes	BCS-156	1	1 <sup>Δ</sup>	up to 2 <sup>Δ</sup>	—

† Thermo-conductive base and insulative exterior Δ Requires extension collar accessory for closed lid cooling \*\* Lid closure not possible even with the addition of extension collar

## Choose Your Ice-Free Cooling Workstation System



	Cooling Workstation Open Platform, Single Capacity	Cooling Workstation, Single Capacity & Cooling Workstation, Double Capacity	Cooling Workstation for use with Smaller Thermoconductive Tube Rack
<b>Holds Tubes</b>	Yes	Yes	Yes
<b>Holds Plates</b>	Yes	Yes	n/a
<b>0.5° - 4°C cooling with lid open</b>	4 hours	10 hours	4 hours
<b>0.5° - 4°C cooling with lid closed</b>	n/a	16 hours	10 hours
<b>&lt;0°C freezing with lid open</b>	n/a	5 hours	3 hours
<b>&lt;0°C freezing with lid closed</b>	n/a	8 hours	6 hours



## Cooling Workstation Open Platform, Single Capacity



An open-platform ice-free cooler that accommodates most Thermoconductive Tube Racks and Thermoconductive Sink modules. Low profile and small footprint make it ideal for use in the hood, keeping samples cold (0.5° to 4.0°C) up to four hours. 1°C to 8°C temperature indicator provides visual assurance of temperature performance. To extend the cooling duration, keep an additional Cooling Workstation Cooling Core in the freezer and rotate the Cores as needed.

### Ordering Information

<b>BCS-504</b>	<b>Cooling Workstation System</b> , single capacity open platform, cooling core included, <b>purple</b> , 1 system
<b>BCS-513</b>	<b>Cooling Workstation</b> , single capacity, open platform holder, <b>purple</b> , 1 holder
<b>BCS-511</b>	<b>Cooling Workstation Cooling Core</b> , 0.5°C to 4°C, <b>blue</b>

## Cooling Workstation, Single Capacity or Double Capacity System

Keep sample tubes or plates cold for over 16 hours with the lid on, and over 10 hours with the lid off. Use optional Cooling Workstation Freezing Core to maintain frozen samples for over 8 hours. Dry ice may be used in place of the cores to create a compact snap freezing workstation.



### Cooling Workstation, Single Capacity

Includes: Cooling Workstation, Single Capacity base, collar, lid and (1) Cooling Workstation Cooling Core for 0.5° to 4°C cooling.



### Cooling Workstation, Double Capacity

Includes: Cooling Workstation, Double Capacity base, collar, lid and (2) Cooling Workstation Cooling Core for 0.5° to 4°C cooling.

### Ordering Information

<b>BCS-502</b>	<b>Cooling Workstation</b> , single capacity, cooling core included, <b>purple</b>
<b>BCS-502G</b>	<b>Cooling Workstation</b> , single capacity, cooling core included, <b>green</b>
<b>BCS-502O</b>	<b>Cooling Workstation</b> , single capacity, cooling core included, <b>orange</b>
<b>BCS-502PK</b>	<b>Cooling Workstation</b> , single capacity, cooling core included, <b>pink</b>
<b>BCS-502-F</b>	<b>Cooling Workstation</b> , single capacity, freezing core included, <b>purple</b>

\* Internal height of open space when core is in the base.

### Ordering Information

<b>BCS-503</b>	<b>Cooling Workstation</b> , double capacity, cooling core included, <b>purple</b>
<b>BCS-503G</b>	<b>Cooling Workstation</b> , double capacity, cooling core included, <b>green</b>
<b>BCS-503O</b>	<b>Cooling Workstation</b> , double capacity, cooling core included, <b>orange</b>
<b>BCS-503PK</b>	<b>Cooling Workstation</b> , double capacity, cooling core included, <b>pink</b>
<b>BCS-503-F</b>	<b>Cooling Workstation</b> , double capacity, freezing core included, <b>purple</b>

\* Internal height of open space when core is in the base.

## Optional Accessories



### Cooling Workstation Single Capacity and Cooling Workstation Double Capacity Extension Collar

For use with Cooling Workstation Single Capacity and Cooling Workstation Double Capacity systems to accommodate tall tube modules. The collar is magnetized and easily adheres to the unit base.

### Ordering Information

<b>BCS-502-C</b>	Cooling Workstation Extension Collar, for Cooling Workstation, purple
<b>BCS-502-CG</b>	Cooling Workstation Extension Collar, for Cooling Workstation, green
<b>BCS-502-CO</b>	Cooling Workstation Extension Collar, for Cooling Workstation, orange
<b>BCS-502-CPK</b>	Cooling Workstation Extension Collar, for Cooling Workstation, pink
<b>BCS-503-C</b>	Cooling Workstation Extension Collar, for Cooling Workstation Large, purple
<b>BCS-503-CG</b>	Cooling Workstation Extension Collar, for Cooling Workstation Large, green
<b>BCS-503-CO</b>	Cooling Workstation Extension Collar, for Cooling Workstation Large, orange
<b>BCS-503-CPK</b>	Cooling Workstation Extension Collar, for Cooling Workstation Large, pink

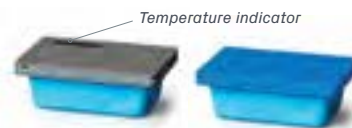

### Cooling Workstation Cores

Keep additional cooling or freezing cores in the freezer for flexibility and extended duration. Cooling Workstation Cooling Core features a 1 to 8°C temperature indicator. Both cooling and freezing cores feature a thermo-conductive surface for uniform temperature distribution.

### Ordering Information

<b>BCS-511</b>	Cooling Workstation Cooling Core, 0.5°C to 4°C, blue
<b>BCS-512</b>	Cooling Workstation Freezing Core, below 0°C, blue

## Cooling Workstation for use with Smaller Thermoconductive Tube Rack

Keeps tubes cold (0.5° to 4.0°C) for up to 10 hours. Use the optional freezing cartridge to maintain frozen samples below 0°C for up to 6 hours.



### Cooling Workstation for use with Smaller Thermoconductive Tube Rack

Includes: Cooling Workstation for use with Smaller Thermoconductive Tube Rack base and lid, blue cooling cartridge.



Cooling Workstation Cartridges

### Ordering Information

<b>BCS-130</b>	Cooling Workstation, single capacity, for use with smaller thermo-conductive tube racks (that hold 15 or 30 tubes), cooling cartridge included, purple
<b>Cooling Workstation Cartridges</b>	
<b>BCS-132</b>	Cooling Workstation Cooling Cartridge, for use with BCS-130, 3 pack, blue
<b>BCS-131</b>	Cooling Workstation Freezing Cartridge, for use with BCS-130, 3 pack, green

\* Internal height of open space when core is in the base.

## Popular Pre-assembled Configurations

### Cooling Workstation Open Platform, Single Capacity PCR Cooling Systems, pre-assembled



#### Ordering Information

<b>BCS-556</b>	Cooling Workstation System, pre-assembled open-platform, for use with PCR plates, includes 1 x BCS-504 (Cooling Workstation System) and 1 x BCS-529 (Thermoconductive Tube Rack), purple
<b>BCS-557</b>	Cooling Workstation System, pre-assembled open-platform, for use with PCR strip wells, includes 1 x BCS-504 (Cooling Workstation System) and 1 x BCS-523 (Thermoconductive Tube Rack), purple

### Cooling Workstation Single Capacity and Cooling Workstation Double Capacity Systems, pre-assembled



#### Ordering Information

<b>BCS-576</b>	Cooling Workstation System, pre-assembled for use with 24 microtubes, includes 1 x BCS-502 (Cooling Workstation) and 1 x BCS-535 (Thermoconductive Tube Rack), purple
<b>BCS-575</b>	Cooling Workstation System, pre-assembled for use with 24 cryo tubes, includes 1 x BCS-502 (Cooling Workstation) and 1 x BCS-534 (Thermoconductive Tube Rack), purple
<b>BCS-570</b>	Cooling Workstation System, pre-assembled for use with PCR plates, includes 1 x BCS-502 (Cooling Workstation) and 1 x BCS-529 (Thermoconductive Tube Rack), purple
<b>BCS-572</b>	Cooling Workstation System, pre-assembled for use with PCR strip wells, includes 1 x BCS-502 (Cooling Workstation) and 1 x BCS-523 (Thermoconductive Tube Rack), purple
<b>BCS-573</b>	Cooling Workstation System, pre-assembled for use with PCR plates, includes 1 x BCS-503 (Cooling Workstation), 1 x BCS-529 and 1 x BCS-535 (Thermoconductive Tube Rack), purple

### Cooling Workstation for use with Smaller Thermoconductive Tube Rack Systems, pre-assembled



#### Ordering Information

<b>BCS-133</b>	Cooling Workstation System, pre-assembled for use with microcentrifuge tubes, 1 x BCS-130 (Cooling Workstation) and 1 x BCS-108 (Thermoconductive Tube Rack) included, purple
<b>BCS-166</b>	Cooling Workstation System, pre-assembled for use with cryogenic vials and FACS tube modules, 1 x BCS-130 (Cooling Workstation) and 1 x BCS-138 (Thermoconductive Tube Rack) included, purple

# Thermoconductive Tube Racks





# Thermoconductive Tube Racks



**Thermoconductive tube modules** eliminate variability which originates from tubes placed directly into ice, dry ice, alcohol baths, water baths and other temperature sources. Place the Thermoconductive Tube Rack module directly onto a temperature source between  $-196^{\circ}\text{C}$  to  $>100^{\circ}\text{C}$  and it will rapidly adapt to that temperature. Thermoconductive Tube Rack modules ensure  $\pm 0.1^{\circ}\text{C}$  temperature uniformity across all tubes when cooling, snap freezing, heating or thawing. Suggested applications include cooling reagents such as restriction enzymes, dNTPs and antibodies, alcohol-free dry ice snap freezing of tissue, virus and bacteria samples and bench top cryogenic tube sorting in liquid nitrogen. All Thermoconductive Tube Rack modules may be autoclaved, high heat sterilized or decontaminated with bleach, alcohol or other disinfectants or lab detergents. Certain Thermoconductive Tube Rack modules are SBS-compatible.

## Problem: Samples in Ice

- Non-uniform ice contact results in variable sample temperature
- Disorganized samples, wet labels
- Shifting, sinking tubes; contamination risk
- Non-reproducible method



## Solution: Samples in Thermoconductive Tube Rack Module

- All samples  $<4^{\circ}\text{C}$  and uniform in temperature ( $\pm 0.1^{\circ}\text{C}$ )
- Samples organized, secure and dry
- All tubes upright and indexed
- Reproducible method



## How It Works

### Cooling



**Thermoconductive Tube Rack on Ice:** Heat from the relatively warmer Thermoconductive Tube Rack module is transferred to cooling source (wet or dry ice, cartridge,  $\text{LN}_2$ ) until equilibrium is reached.

### Heating



**Thermoconductive Tube Rack in Water Bath:** Heat is transferred from water bath toward relatively cooler Thermoconductive Tube Rack until equilibrium is reached.

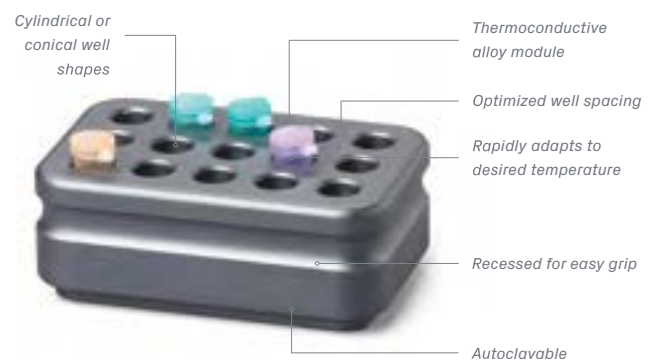

Thermoconductive Tube Racks and Sinks are precision-engineered sample modules manufactured from a novel thermo-conductive alloy material. Thermoconductivity is the transfer of heat energy from a higher temperature region to a lower temperature region. Tube Rack modules evenly distribute the temperature across all wells providing very uniform and consistent temperature to all samples ( $\pm 0.1^{\circ}\text{C}$ ).



# Thermoconductive Tube Racks

## Thermoconductive Tube Rack Reproducibility

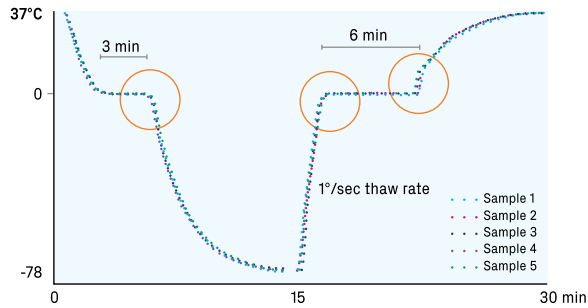

**Performance test:** A temperature probe was placed into a 2.0 mL cryogenic vial containing 1.0 mL of water. The tube was inserted into a Thermoconductive Tube Rack for 45 Cryo or FACS Tubes module. The module was placed onto a Thermoconductive Tray platform in a 37°C water bath and allowed to equilibrate. The Tube Rack for 45 Cryo or FACS Tubes module was then removed and placed onto dry ice and equilibrated to -78°C (0 - 15 minutes) and then returned to the water bath to re-equilibrate to 37°C (15 - 30 minutes). This experiment was repeated five consecutive times and temperature profiles were recorded.

**Conclusion:** The Thermoconductive Tube Rack for 45 Cryo or FACS Tubes module showed identical cooling profiles and phase transition (orange circles) over five consecutive freeze-thaw cycles.

## Thermoconductive Tube Rack Versatility and Performance

### On Ice

- Adapts from ambient (25°C) to <4°C in 60-90 seconds\*
- Samples and labels stay dry, organized
- Hours of ice cooling without direct ice contact
- Reproducible method

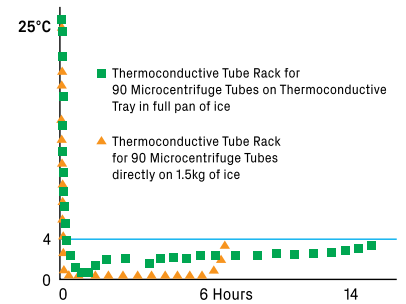

### On Dry Ice

- Adapts from ambient (25°C) to -78°C in approximately 5-7 minutes\*
- Eliminates ethanol from snap freezing
- Samples are upright and organized as they freeze
- Equal or better freezing rate as compared to direct immersion into dry ice or alcohol slurry
- Reproducible method

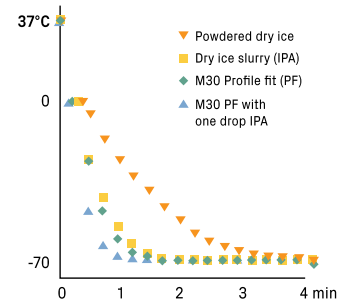

### In Liquid Nitrogen (LN<sub>2</sub>)

- Adapts from ambient (25°C) to approximately -150°C in approximately 12-14 minutes\*
- Vapor barrier protects from ambient air
- Samples are upright and organized as they freeze
- No direct contact between samples and LN<sub>2</sub>
- Reproducible method

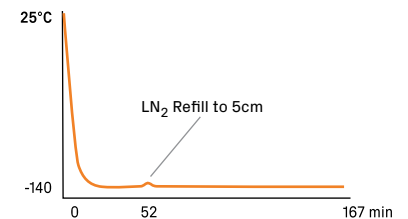

### With Heat Sources

- Use with water baths, hot plates, incubators and other heat sources to keep samples warm



\* Average cooling rate from room temperature



## Thermoconductive Tube Rack Modules

### Thermoconductive Tube Racks for Microcentrifuge Tubes



### Ordering Information

<b>BCS-163</b>	Thermoconductive Tube Rack, holds 6 x 1.5 or 2ml microcentrifuge tubes, cylindrical wells, gray
<b>BCS-165</b>	Thermoconductive Tube Rack, holds 6 x 1.5 or 2ml microcentrifuge tubes, cylindrical wells, orange
<b>BCS-164</b>	Thermoconductive Tube Rack, holds 6 x 1.5 or 2ml microcentrifuge tubes, cylindrical wells, green
<b>BCS-125</b>	Thermoconductive Tube Rack, holds 15 x 1.5 or 2ml microcentrifuge tubes, cylindrical wells, gray
<b>BCS-125G</b>	Thermoconductive Tube Rack, holds 15 x 1.5 or 2ml microcentrifuge tubes, cylindrical wells, green
<b>BCS-125O</b>	Thermoconductive Tube Rack, holds 15 x 1.5 or 2ml microcentrifuge tubes, cylindrical wells, orange
<b>BCS-127</b>	Thermoconductive Tube Rack, holds 15 x 1.5 conical tubes, conical wells, gray
<b>BCS-535</b>	Thermoconductive Tube Rack, holds 24 x 1.5 or 2ml microcentrifuge tubes, cylindrical wells, SBS compatible, gray*
<b>BCS-539</b>	Thermoconductive Tube Rack, holds 12 x 5ml microcentrifuge tubes, conical wells, SBS compatible, gray*
<b>BCS-108</b>	Thermoconductive Tube Rack, holds 30 x 1.5 or 2ml microcentrifuge tubes, cylindrical wells, gray
<b>BCS-108G</b>	Thermoconductive Tube Rack, holds 30 x 1.5 or 2ml microcentrifuge tubes, cylindrical wells, green
<b>BCS-108O</b>	Thermoconductive Tube Rack, holds 30 x 1.5 or 2ml microcentrifuge tubes, cylindrical wells, orange
<b>BCS-128</b>	Thermoconductive Tube Rack, holds 30 x 1.5 conical tubes, conical wells, gray
<b>BCS-137</b>	Thermoconductive Tube Rack, holds 30 x 500ul microcentrifuge tubes, conical wells, gray
<b>BCS-102</b>	Thermoconductive Tube Rack, holds 90 x 1.5 or 2ml microcentrifuge tubes, cylindrical wells, gray
<b>BCS-116</b>	Thermoconductive Tube Rack, holds 96 x 1.5 or 2ml microcentrifuge tubes, cylindrical wells, SBS compatible, row and column indexing, gray**

\* SBS-compatible \*\* Thermoconductive Tube Rack for 96 Microcentrifuge Tubes has A-H and 1-12 row and column indexing

### Thermoconductive Tube Racks for Cryo or FACS Tubes



### Ordering Information

<b>BCS-126</b>	Thermoconductive Tube Rack, holds 15 cryo tubes or FACS tube modules, cylindrical wells, gray
<b>BCS-534</b>	Thermoconductive Tube Rack, holds 24 cryo tubes or FACS tube modules, cylindrical "gripping" wells for one-hand opening/closing vials, SBS compatible, gray*†
<b>BCS-138</b>	Thermoconductive Tube Rack, holds 30 cryo tubes or FACS tube modules, cylindrical "gripping" wells for one-hand opening/closing vials, gray†
<b>BCS-105</b>	Thermoconductive Tube Rack, holds 45 cryo tubes or FACS tube modules, cylindrical wells, gray

\* SBS-compatible † "gripping" wells for one-hand vial opening/closing

## Thermoconductive Tube Racks

### Thermoconductive Tube Racks for PCR Plate, Strip Well or Tubes



### Ordering Information

<b>BCS-529</b>	Thermoconductive Tube Rack, holds one 96-well PCR plate, 12 x strip wells or 96 tubes, tapered wells, SBS compatible, gray*
<b>BCS-523</b>	Thermoconductive Tube Rack, holds 6 strips wells and 12 x 1.5 or 2ml microcentrifuge tubes, 48 tapered wells for strips and 12 cylindrical wells, SBS compatible, gray*
<b>BCS-538</b>	Thermoconductive Tube Rack, holds one 384-well PCR plate, tapered wells, SBS compatible, gray*

\*SBS-compatible

### Thermoconductive Tube Racks for 96-Well 2D Coded Storage Tubes



### Ordering Information

<b>BCS-231</b>	Thermoconductive Tube Rack, holds 96 x 0.5ml 2D storage tubes, cylindrical wells, gray
<b>BCS-149</b>	Thermoconductive Tube Rack, holds 96 x 1ml 2D storage tubes, cylindrical wells, gray

### Thermoconductive Tube Racks for Cell Therapy Injectable Ampules



### Ordering Information

<b>BCS-266</b>	Thermoconductive Tube Rack, holds 12 x 10ml injectable cell therapy ampules, cylindrical wells, gray
<b>BCS-265</b>	Thermoconductive Tube Rack, holds 12 x 2ml injectable cell therapy ampules, cylindrical wells, gray



## Tall Tube Modules

Thermoconductive Tube Racks for 15mL, 50mL and 250mL Centrifuge Tubes



### Ordering Information

<b>BCS-232</b>	Thermoconductive Tube Rack, holds 12 x 15ml centrifuge tubes, cylindrical wells, with thermoconductive base and insulative exterior, purple*
<b>BCS-153</b>	Thermoconductive Tube Rack, holds 9 x 15ml centrifuge tubes, cylindrical wells, gray
<b>BCS-154</b>	Thermoconductive Tube Rack, holds 4 x 50ml centrifuge tubes, cylindrical wells, gray
<b>BCS-532</b>	Thermoconductive Tube Rack, holds one 250ml centrifuge tube, conical well, gray
<b>BCS-533</b>	Thermoconductive Tube Rack, holds one 250ml centrifuge tube, cylindrical well, gray

\* Thermo-conductive base and insulative exterior

Thermoconductive Tube Rack for Blood Collection Tubes



### Ordering Information

<b>BCS-235</b>	Thermoconductive Tube Rack, holds 12 x13mm or 16mm blood tubes, cylindrical wells, with thermoconductive base and insulative exterior, purple
<b>BCS-157</b>	Thermoconductive Tube Rack, holds 9 13x75mm blood tubes, cylindrical wells, gray
<b>BCS-155</b>	Thermoconductive Tube Rack, holds 9 13x100mm blood tubes, cylindrical wells, gray
<b>BCS-156</b>	Thermoconductive Tube Rack, holds 9 16x100mm blood tubes, cylindrical wells, gray

\* Thermo-conductive base and insulative exterior



# Thermoconductive Sinks and Trays



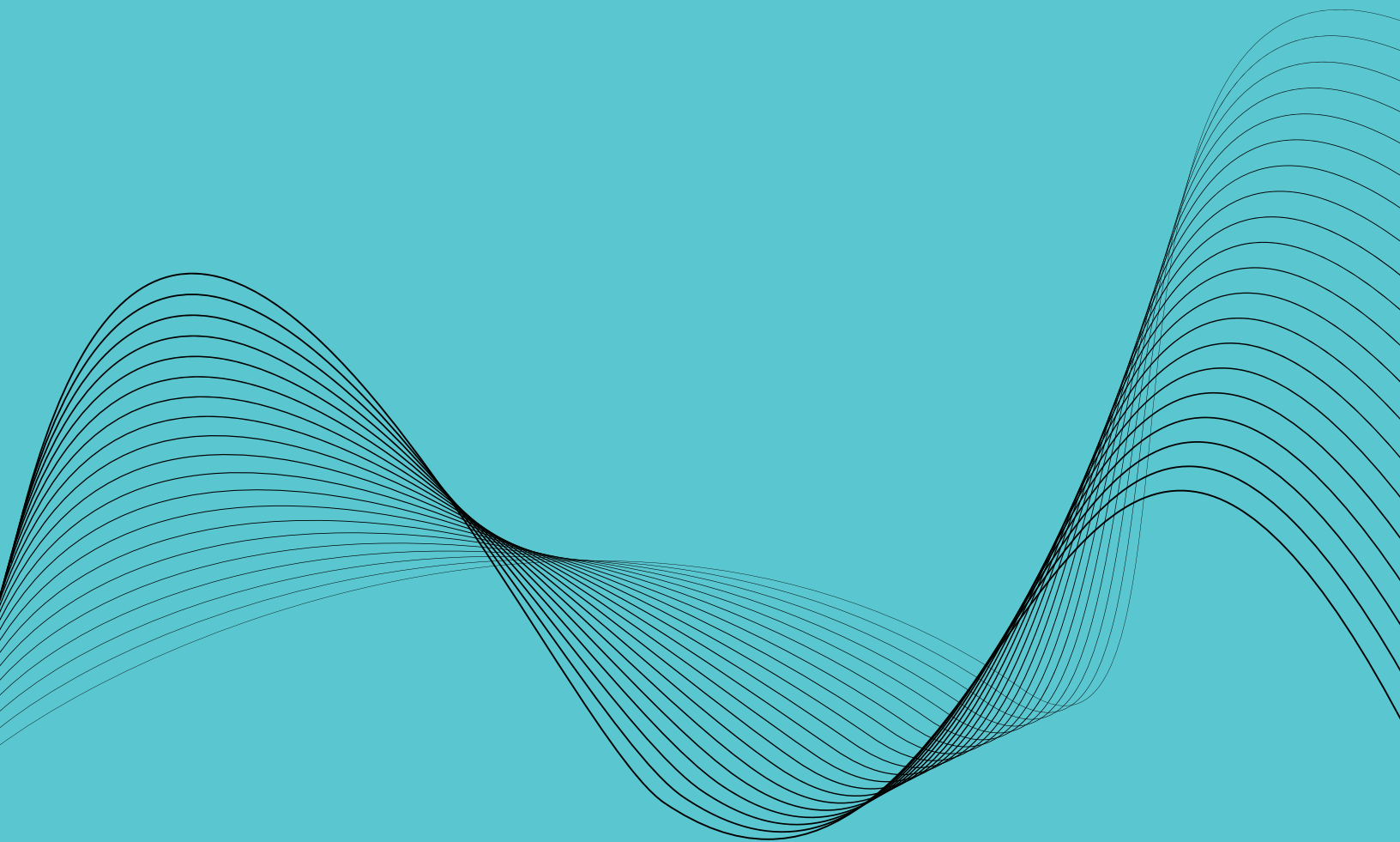

**AZENTA**  
LIFE SCIENCES

# Thermoconductive Sinks

**Thermoconductive plate and reservoir modules** provide uniform temperature to all wells, regardless of position. When placed onto a temperature source such as ice, dry ice, liquid nitrogen or water baths, the Thermoconductive Sink module will rapidly adapt to that temperature - from -196°C to >+100°C. Sink modules ensure temperature sample uniformity when cooling, snap freezing, heating or thawing samples. All Thermoconductive Sink modules may be autoclaved, high heat sterilized or decontaminated with bleach, alcohol or other disinfectants or lab detergents. All modules are compatible with all temperature sources.

## Problem: Non-Uniform Plate Cooling with Crushed Ice

Final equilibrium well temperature for a 96-well flat bottom plate in direct contact with crushed ice.

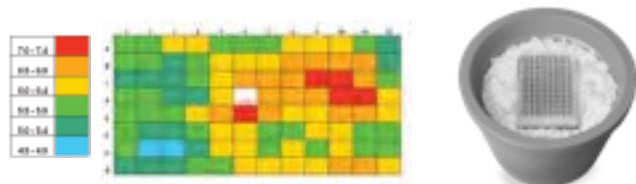

## Solution: Uniform Plate Cooling with Thermoconductive Sink for use with Flat Bottom Plates Module

Final equilibrium well temperature for a 96-well flat bottom plate in direct contact with crushed ice.

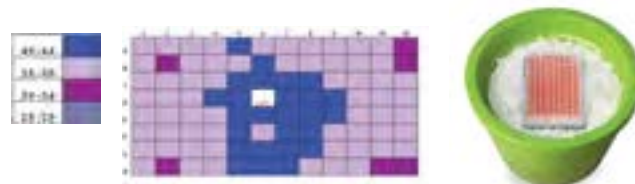

## Plate and Reservoir Modules

### Thermoconductive Sink, SBS-Compatible Plate Modules



### Thermoconductive Sink for use with 55mL Reagent Reservoirs



## Ordering Information

<b>BCS-536</b>	Thermoconductive Sink, for use with 6-, 12-, 24-, 48-, 96-, 384-well flat bottom plates, SBS compatible, gray
<b>BCS-537</b>	Thermoconductive Sink, for use with one 96-well U-bottom plate, SBS compatible, gray

## Ordering Information

<b>BCS-184</b>	Thermoconductive Sink, for use with 55ml reagent reservoirs, gray
----------------	---



# Thermoconductive Trays

**Thermoconductive platforms** support Thermoconductive Tube Rack and Sink modules in liquid temperature sources such as melting ice, water baths and liquid nitrogen. Designed with a stable, sturdy design and made of the same highly conductive alloy as our Tube Rack and Sink modules. Thermoconductive Tray platforms are ideal for processing temperature-sensitive samples, as they conduct the source temperature to the rack and sink modules and, ultimately, to your samples. All platforms may be autoclaved, high heat sterilized or decontaminated with bleach, alcohol or other disinfectants or lab detergents.

## In Ice

Keep samples <4°C for over 10 hours while ice melts

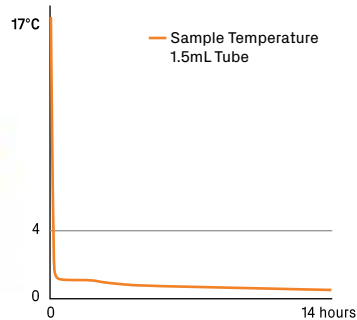

## In Liquid Nitrogen

Keep samples at -140°C with liquid nitrogen

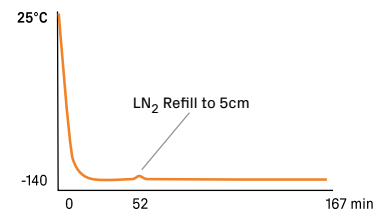

## Thermoconductive Trays

Thermoconductive Tray platforms are compatible with all temperature sources. If using in liquid nitrogen, the Thermoconductive Tray Slim with Low-Profile is highly recommended. These low profile Tray platforms allow development of a vapor layer which will help insulate samples from ambient air.



## Ordering Information

<b>BCS-252</b>	Thermoconductive Tray, slim with low-profile, for use in 9L ice pan with LN2, gray
<b>BCS-123</b>	Thermoconductive Tray, with low-profile, for use in 9L ice pan with crushed ice, gray
<b>BCS-104</b>	Thermoconductive Tray, with high-profile, for use in water bath, gray

## With Heat Sources

- Use with water baths, hot plates, incubators and other heat sources to keep samples warm

\* Average cooling rate from room temperature

# Accessories

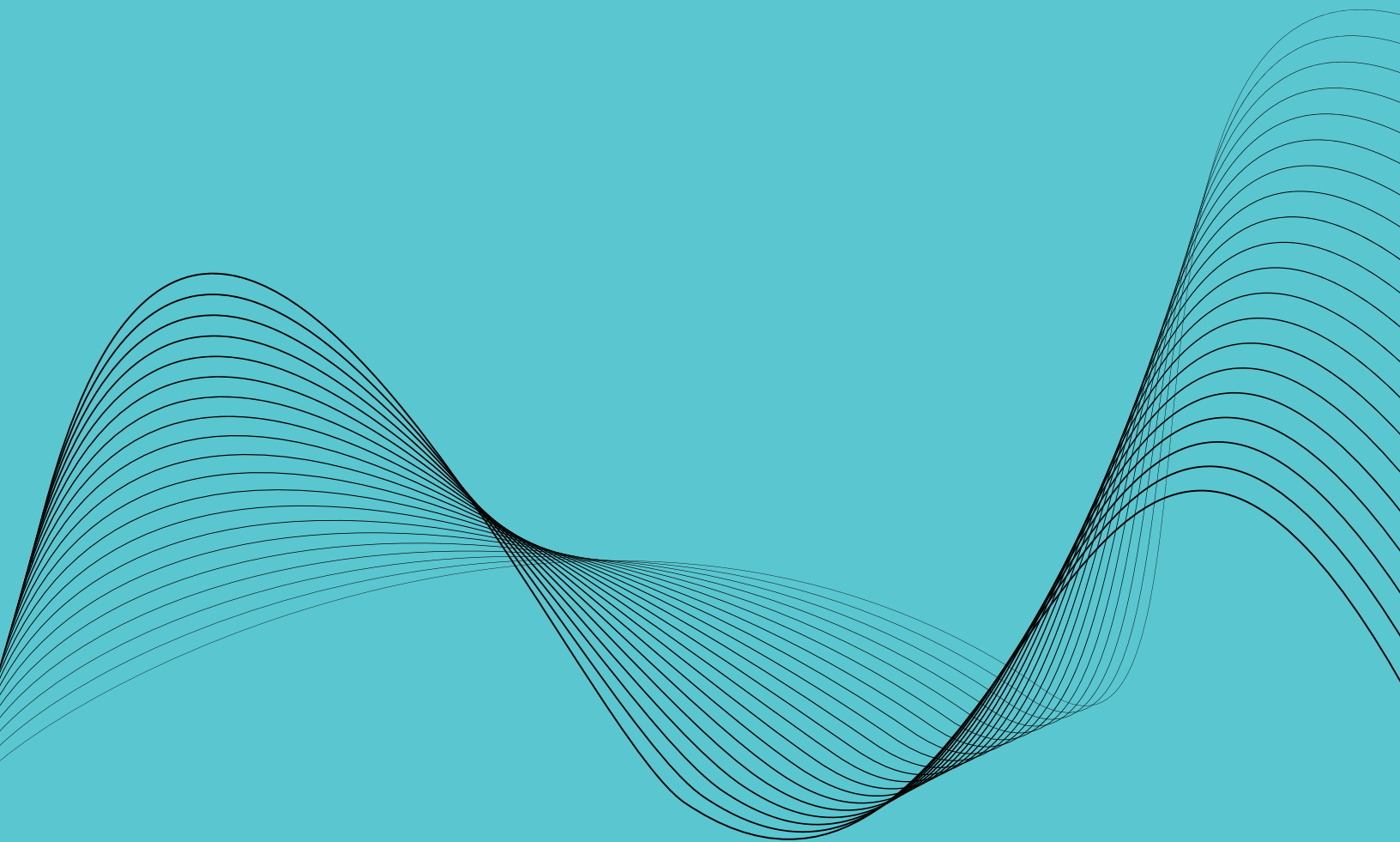

# Accessories



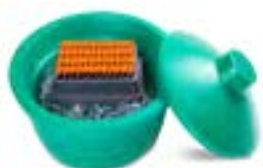

## Ice Pans

Non-toxic, recyclable ethyl-vinyl acetate (EVA) foam containers for use with ice, dry ice, liquid nitrogen, alcohol slurries. Will not sweat, leak or skid on bench.



## Ordering Information

	<b>Ice Pan without Lid, Square 1L</b>
<a href="#">BCS-211PL</a>	Ice Pan, without Lid, square, 1L, purple
<a href="#">BCS-211GR</a>	Ice Pan, without Lid, square, 1L, lime green
<a href="#">BCS-211OR</a>	Ice Pan, without Lid, square, 1L, orange
<a href="#">BCS-211PK</a>	Ice Pan, without Lid, square, 1L, pink
<a href="#">BCS-211B</a>	Ice Pan, without Lid, square, 1L, blue
<a href="#">BCS-211</a>	Ice Pan, without Lid, square, 1L, green
<a href="#">BCS-212</a>	Ice Pan, without Lid, square, 1L, red
	<b>Ice Pan without Lid, Rectangle 4L</b>
<a href="#">BCS-113PL</a>	Ice Pan, without Lid, rectangle, 4L, purple
<a href="#">BCS-113GR</a>	Ice Pan, without Lid, rectangle, 4L, lime green
<a href="#">BCS-113OR</a>	Ice Pan, without Lid, rectangle, 4L, orange
<a href="#">BCS-113PK</a>	Ice Pan, without Lid, rectangle, 4L, pink
<a href="#">BCS-113B</a>	Ice Pan, without Lid, rectangle, 4L, blue
<a href="#">BCS-113</a>	Ice Pan, without Lid, rectangle, 4L, green
<a href="#">BCS-114</a>	Ice Pan, without Lid, rectangle, 4L, red
	<b>Ice Pan with Lid, Rectangle 4L</b>
<a href="#">BCS-117PL</a>	Ice Pan, with Lid, rectangle, 4L, purple
<a href="#">BCS-117GR</a>	Ice Pan, with Lid, rectangle, 4L, lime green
<a href="#">BCS-117OR</a>	Ice Pan, with Lid, rectangle, 4L, orange
<a href="#">BCS-117PK</a>	Ice Pan, with Lid, rectangle, 4L, pink
<a href="#">BCS-117B</a>	Ice Pan, with Lid, rectangle, 4L, blue

	<b>Ice Pan without Lid, Rectangle 9L</b>
<a href="#">BCS-111PL</a>	Ice Pan, without Lid, rectangle, 9L, purple
<a href="#">BCS-111GR</a>	Ice Pan, without Lid, rectangle, 9L, lime green
<a href="#">BCS-111OR</a>	Ice Pan, without Lid, rectangle, 9L, orange
<a href="#">BCS-111PK</a>	Ice Pan, without Lid, rectangle, 9L, pink
<a href="#">BCS-111B</a>	Ice Pan, without Lid, rectangle, 9L, blue
<a href="#">BCS-111</a>	Ice Pan, without Lid, rectangle, 9L, green
<a href="#">BCS-112</a>	Ice Pan, without Lid, rectangle, 9L, red
	<b>Ice Pan with Lid, Rectangle 9L</b>
<a href="#">BCS-118PL</a>	Ice Pan, with Lid, rectangle, 9L, purple
<a href="#">BCS-118GR</a>	Ice Pan, with Lid, rectangle, 9L, lime green
<a href="#">BCS-118B</a>	Ice Pan, with Lid, rectangle, 9L, blue
	<b>Ice Pan with Lid, Round 2.5L</b>
<a href="#">BCS-115-25PL</a>	Ice Bucket, with Lid, round, 2.5L, purple
<a href="#">BCS-115-25GR</a>	Ice Bucket, with Lid, round, 2.5L, lime green
<a href="#">BCS-115-25OR</a>	Ice Bucket, with Lid, round, 2.5L, orange
<a href="#">BCS-115-25PK</a>	Ice Bucket, with Lid, round, 2.5L, pink
<a href="#">BCS-115-25B</a>	Ice Bucket, with Lid, round, 2.5L, blue
<a href="#">BCS-115-25G</a>	Ice Bucket, with Lid, round, 2.5L, green
<a href="#">BCS-115-25R</a>	Ice Bucket, with Lid, round, 2.5L, red
	<b>Ice Pan with Lid, Round 4L</b>
<a href="#">BCS-115PL</a>	Ice Bucket, with Lid, round, 4L, purple
<a href="#">BCS-115GR</a>	Ice Bucket, with Lid, round, 4L, lime green
<a href="#">BCS-115OR</a>	Ice Bucket, with Lid, round, 4L, orange
<a href="#">BCS-115PK</a>	Ice Bucket, with Lid, round, 4L, pink
<a href="#">BCS-115B</a>	Ice Bucket, with Lid, round, 4L, blue
<a href="#">BCS-115</a>	Ice Bucket, with Lid, round, 4L, green
<a href="#">BCS-115R</a>	Ice Bucket, with Lid, round, 4L, red



## Hinged CryoBoxes

Patented hinged lid offers convenience and archival integrity, ensuring markings and vials remain in sync. Lid stays attached to base minimizing risk of separation and lid contamination. Lid is easy to open when frozen. Available in 9x9, 10x10, and vapor phase LN<sub>2</sub> compatible formats. Plastic 81-place grid has adjustable slats to accommodate multiple vial types. 2-inch box holds 1.0 mL or 2.0 mL cryogenic vials and microcentrifuge tubes. 3.5-inch box holds 3.0 mL to 5.0 mL cryogenic vials.

Hinged cryoboxes can be customized to suit various requirements. Options include new colors, logos, designs, grid sizes and additional components.



## Ordering Information

Hinged CryoBox 2 Inch, 81-Place	
<b>BCS-206</b>	Cryobox, 2-inch cryobox, hinged, adjustable plastic grid, 81-place, <b>white</b> , 5 per case
<b>BCS-206B</b>	Cryobox, 2-inch cryobox, hinged, adjustable plastic grid, 81-place, <b>blue</b> , 5 per case
<b>BCS-206G</b>	Cryobox, 2-inch cryobox, hinged, adjustable plastic grid, 81-place, <b>green</b> , 5 per case
<b>BCS-206O</b>	Cryobox, 2-inch cryobox, hinged, adjustable plastic grid, 81-place, <b>orange</b> , 5 per case
<b>BCS-206P</b>	Cryobox, 2-inch cryobox, hinged, adjustable plastic grid, 81-place, <b>purple</b> , 5 per case
<b>BCS-206PK</b>	Cryobox, 2-inch cryobox, hinged, adjustable plastic grid, 81-place, <b>pink</b> , 5 per case
<b>BCS-206MC</b>	Cryobox, 2-inch cryobox, hinged, adjustable plastic grid, 81-place, multipack, no <b>white</b> , 5 per case
<b>BCS-207</b>	Cryobox, 2-inch cryobox, hinged, adjustable plastic grid, 81-place, <b>white</b> , 50 per case
<b>BCS-207B</b>	Cryobox, 2-inch cryobox, hinged, adjustable plastic grid, 81-place, <b>blue</b> , 50 per case
<b>BCS-207G</b>	Cryobox, 2-inch cryobox, hinged, adjustable plastic grid, 81-place, <b>green</b> , 50 per case
<b>BCS-207O</b>	Cryobox, 2-inch cryobox, hinged, adjustable plastic grid, 81-place, <b>orange</b> , 50 per case
<b>BCS-207P</b>	Cryobox, 2-inch cryobox, hinged, adjustable plastic grid, 81-place, <b>purple</b> , 50 per case
<b>BCS-207PK</b>	Cryobox, 2-inch cryobox, hinged, adjustable plastic grid, 81-place, <b>pink</b> , 50 per case

Hinged CryoBox 2 Inch, 100-Place	
<b>BCS-209G</b>	Cryobox, 2-inch cryobox, hinged, adjustable plastic grid, 100-place, <b>green</b> , 5 per case
<b>BCS-209P</b>	Cryobox, 2-inch cryobox, hinged, adjustable plastic grid, 100-place, <b>purple</b> , 5 per case
<b>BCS-220G</b>	Cryobox, 2-inch cryobox, hinged, adjustable plastic grid, 100-place, <b>green</b> , 50 per case
<b>BCS-220P</b>	Cryobox, 2-inch cryobox, hinged, adjustable plastic grid, 100-place, <b>purple</b> , 50 per case
Hinged CryoBox 3.5in, 81-Place	
<b>BCS-215G</b>	Cryobox, 3.5-inch cryobox, hinged, adjustable plastic grid, 81-place, <b>green</b> , 6 per case
<b>BCS-215P</b>	Cryobox, 3.5-inch cryobox, hinged, adjustable plastic grid, 81-place, <b>purple</b> , 6 per case
<b>BCS-219G</b>	Cryobox, 3.5-inch cryobox, hinged, adjustable plastic grid, 81-place, <b>green</b> , 30 per case
<b>BCS-219P</b>	Cryobox, 3.5-inch cryobox, hinged, adjustable plastic grid, 81-place, <b>purple</b> , 30 per case
Hinged CryoBox 2 Inch, 81-Place, With Drain Holes	
<b>BCS-217G</b>	Cryobox, 2-inch cryobox, hinged, adjustable plastic grid, 81-place, LN2 drain holes, <b>green</b> , 5 per case
<b>BCS-217P</b>	Cryobox, 2-inch cryobox, hinged, adjustable plastic grid, 81-place, LN2 drain holes, <b>purple</b> , 5 per case
<b>BCS-221G</b>	Cryobox, 2-inch cryobox, hinged, adjustable plastic grid, 81-place, LN2 drain holes, <b>green</b> , 50 per case
<b>BCS-221P</b>	Cryobox, 2-inch cryobox, hinged, adjustable plastic grid, 81-place, LN2 drain holes, <b>purple</b> , 50 per case

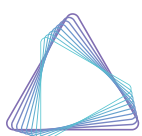

## Thermoconductive Tube Module Temperature Strips



Adhesive temperature display shows the temperature of a surface with 1°C resolution. Ideal for placement on Thermoconductive Tube Rack, Sink and Tray modules.

### Ordering Information

<b>BCS-143</b>	Thermoconductive Tube Module Temperature Strips, 1°-8°C, 3pk.
----------------	---

## Thermoconductive Tube Module Sleeves



### Ordering Information

<b>BCS-205</b>	Thermoconductive Tube Module Sleeves, 4pk
----------------	---

## Cryo Tube Grippers



Cryo Tube Grippers feature a unique design to grasp internal- or external-thread cryogenic vials. Easily sort or move vials while maintaining sterility and protecting fingers from frozen vials, dry ice and liquid nitrogen. 5 per pack.

### Ordering Information

<b>BCS-213MC</b>	Cryo Tube Grippers, multi-color, 5 per case
------------------	---

## Cryo Tube Locking Racks



Cryo Tube Locking Racks feature a locking mechanism that allow one-hand opening for self-standing cryogenic vials. Accommodates both round bottom and self-standing vial formats. Racks have A - J and 1 - 5 row and column indexing for easy organization. Autoclavable. 5 per pack.

### Ordering Information

<b>BCS-222</b>	Cryo Tube Locking Racks, multi-pack, 5 per case
----------------	---

## 1D-coded Cryo Tubes

Leak-proof, auto-cap cryogenic tubes are ideal for cell culture and biobanking. The screw cap features a co-molded thermally-fused gasket which prevents leaking, slipping and risk of contamination. The gasket is 95kPa certified to provide a leak-proof seal. The star socket on cap top is compatible with auto-decapping equipment. Each vial is individually barcoded with a unique identifier that can be read with common barcode readers. Recommended for storage down to vapor phase liquid nitrogen but not suitable for use directly in LN<sub>2</sub>. 500 per case.



Internal Threads

External Threads

### Ordering Information

1.0ml - 5ml 1D-coded Cryo Tube, Internal Thread	
BCS-2510	1ml 1D-coded Cryo Tube, Internal Thread, self-standing, 500 tubes per case
BCS-2511	2ml 1D-coded Cryo Tube, Internal Thread, self-standing, 500 tubes per case
BCS-2512	2ml 1D-coded Cryo Tube, Internal Thread, round-bottom, 500 tubes per case
BCS-2513	4ml 1D-coded Cryo Tube, Internal Thread, round-bottom, 500 tubes per case
BCS-2514	4ml 1D-coded Cryo Tube, Internal Thread, self-standing, 500 tubes per case
BCS-2515	5ml 1D-coded Cryo Tube, Internal Thread, round-bottom, 500 tubes per case
BCS-2516	5ml 1D-coded Cryo Tube, Internal Thread, self-standing, 500 tubes per case

1.0ml - 5ml 1D-coded Cryo Tube, External Thread	
BCS-2517	1ml 1D-coded Cryo Tube, Internal Thread, self-standing, 500 tubes per case
BCS-2501	2ml 1D-coded Cryo Tube, External Thread, round-bottom, 500 tubes per case
BCS-2502	2ml 1D-coded Cryo Tube, External Thread, self-standing, 500 tubes per case
BCS-2503	3ml 1D-coded Cryo Tube, External Thread, self-standing, 500 tubes per case
BCS-2504	4ml 1D-coded Cryo Tube, External Thread, self-standing, 500 tubes per case
BCS-2505	5ml 1D-coded Cryo Tube, External Thread, self-standing, 500 tubes per case

## Cryo Tubes Cap Inserts

Inserts for auto caps. 1,000 per pack.

Caps designed to color code tubes. Ideal for labeling different specimen tubes and cataloging sample inventory.

### Ordering Information

BCS-2436	Cryo Tube Cap Insert, violet, 1000 inserts per case
BCS-2432	Cryo Tube Cap Insert, pink, 1000 inserts per case
BCS-2431	Cryo Tube Cap Insert, green, 1000 inserts per case
BCS-2434	Cryo Tube Cap Insert, yellow, 1000 inserts per case
BCS-2435	Cryo Tube Cap Insert, white, 1000 inserts per case
BCS-2433	Cryo Tube Cap Insert, red, 1000 inserts per case
BCS-2438	Cryo Tube Cap Insert, gray, 1000 inserts per case
BCS-2430	Cryo Tube Cap Insert, blue, 1000 inserts per case
BCS-2437	Cryo Tube Cap Insert, orange, 1000 inserts per case



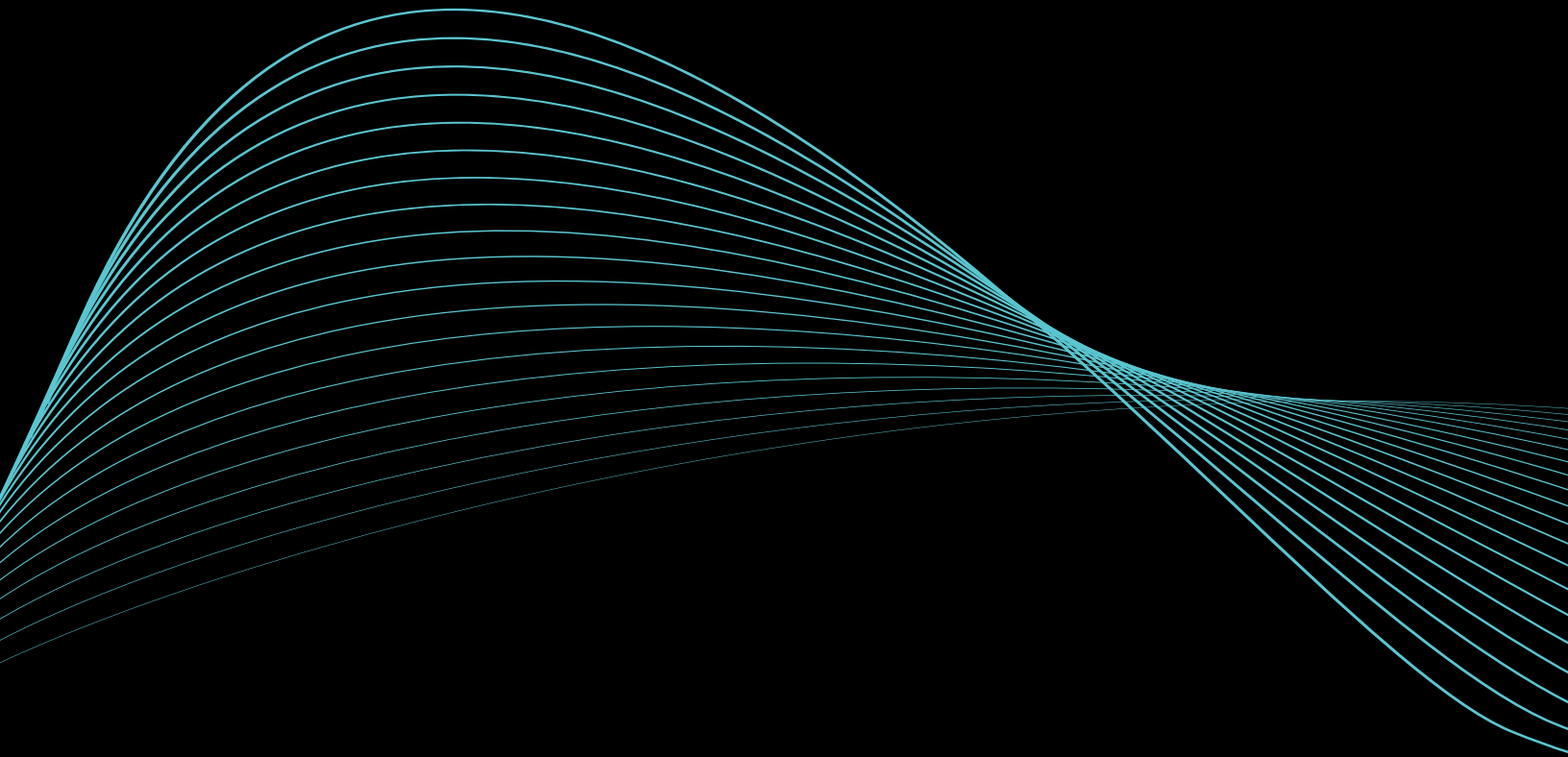

**AZENTA**  
LIFE SCIENCES

# Index

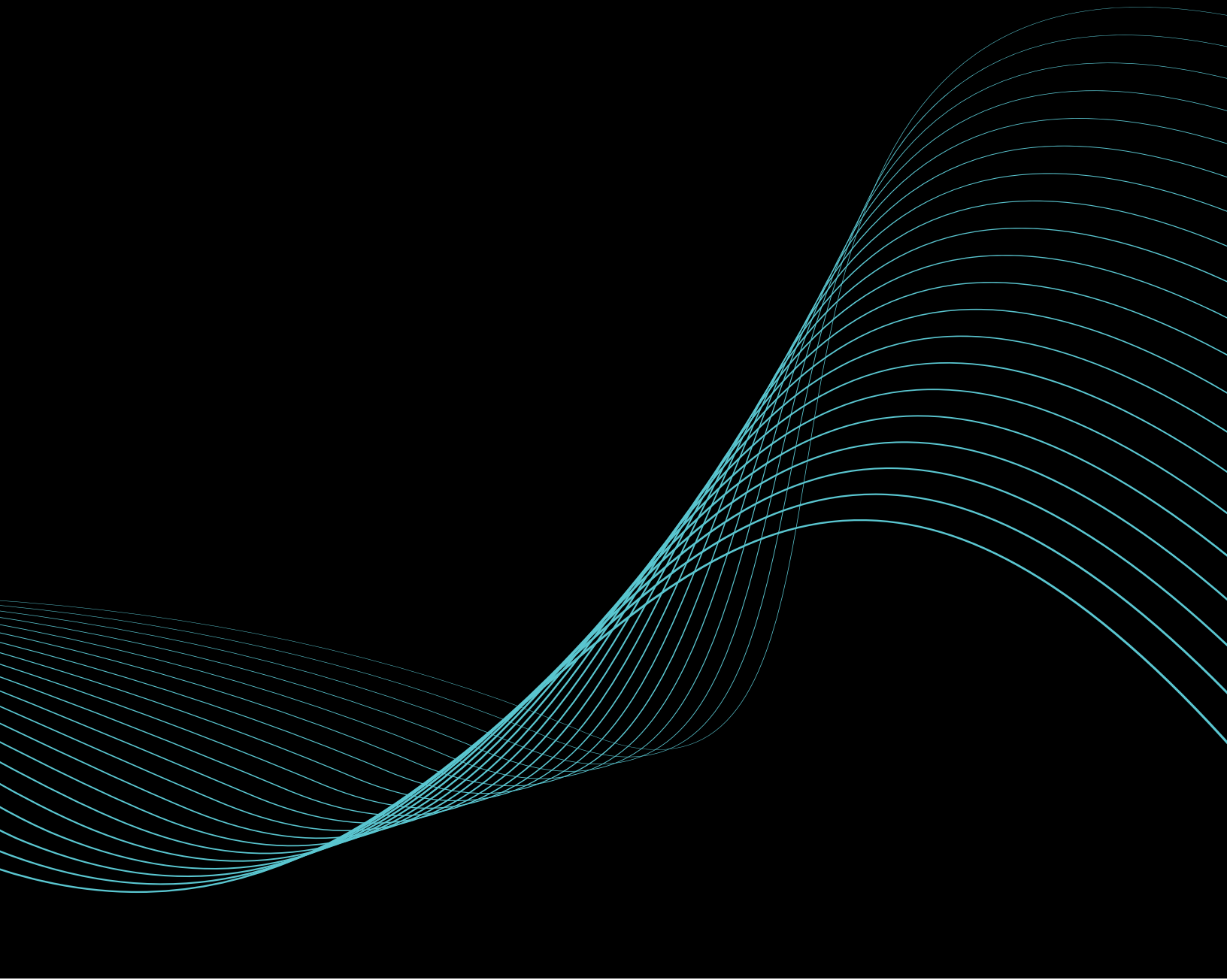



# Part Number Index

Part No.	Page
4ti-0110	196, 198, 279
4ti-0116	198
4ti-0117	198
4ti-0120	196, 198, 279
4ti-0124	197, 279
4ti-0125	197, 279
4ti-0126	195
4ti-0130	196
4ti-0131	199
4ti-0132	195
4ti-0133	199
4ti-0135	196, 279
4ti-0136	195
4ti-0137	195, 279
4ti-0138	196, 198, 279
4ti-0139	194, 279
4ti-0147	194
4ti-0150	201
4ti-0151	200
4ti-0152	202
4ti-0201	204
4ti-0203	204
4ti-0204	204
4ti-0205	204
4ti-0206	204
4ti-0214	207
4ti-0221	205
4ti-0223	205
4ti-0224	205
4ti-0225	205
4ti-0226	205
4ti-0234	208
4ti-0241	206
4ti-0243	206

Part No.	Page
4ti-0244	206
4ti-0245	206
4ti-0246	206
4ti-0254	212
4ti-0262	209
4ti-0263	210
4ti-0264	212
4ti-0273	210
4ti-0274	212
4ti-0280	204, 207, 212, 277
4ti-0281	204, 212, 277
4ti-0282	205, 210, 277
4ti-0283	205, 210, 277
4ti-0284	206, 209, 277
4ti-0285	277
4ti-0286	206, 209, 277
4ti-0287	128, 277
4ti-0288	277
4ti-0289	136, 277
4ti-0290	161, 208, 277
4ti-0291	278
4ti-0292	160
4ti-0370	160
4ti-0371	160
4ti-0372	161
4ti-0373	153, 161
4ti-0380	127
4ti-0380/C	127
4ti-0381	127
4ti-0382	127
4ti-0383	127
4ti-0384	125, 188, 190
4ti-0384/RIG	125
4ti-0385	125

Part No.	Page
4ti-0386	125
4ti-0387	125
4ti-0391	268
4ti-0398	216, 217, 223, 229, 230, 231, 232, 269
4ti-0500	256, 270
4ti-0500FL	260, 270
4ti-0502	256, 257, 259, 260, 261, 262, 263, 264, 265, 266, 267, 268
4ti-0503	268
4ti-0510	266, 270
4ti-0512	261, 270
4ti-0516	204, 205, 206, 209, 210, 211, 264, 270
4ti-0517	265, 270
4ti-0519	267, 270
4ti-0520	220, 234
4ti-0520S	220, 234
4ti-0521	155, 220, 222, 234
4ti-0522	155, 220, 234
4ti-0522S	220, 234
4ti-0523	221, 234
4ti-0523S	221, 234
4ti-0524	221, 234
4ti-0524S	221, 234
4ti-0530	224, 234, 267
4ti-0530S	224, 234
4ti-0531	155, 224, 225, 234
4ti-0532	155, 224, 234
4ti-0532S	224, 234
4ti-0535	228, 234
4ti-0535S	228, 234
4ti-0536	228, 234
4ti-0537	228, 234
4ti-0537S	228, 234

## Part Number Index

Part No.	Page	Part No.	Page	Part No.	Page
4ti-0538	226, 234	4ti-0586S	223, 234	4ti-0750/8/P	177
4ti-0538S	226, 234	4ti-0587	223, 234	4ti-0750/8/R	177
4ti-0539	155, 226, 227, 234	4ti-0590	230, 234	4ti-0750/8/Y	177
4ti-0539S	226, 234	4ti-0590S	230, 234	4ti-0750/16/B	177
4ti-0540	216, 232, 234	4ti-0591	230, 234	4ti-0750/16/G	177
4ti-0540S	216, 234	4ti-0592	230, 234	4ti-0750/16/P	177
4ti-0541	216, 232, 234	4ti-0592S	230, 234	4ti-0750/16/R	177
4ti-0542	216, 234	4ti-0597	231, 234	4ti-0750/16/Y	177
4ti-0542S	216, 234	4ti-0598	231, 234	4ti-0750/24/B	177
4ti-0545	229, 234	4ti-0598S	231, 234	4ti-0750/24/G	177
4ti-0545S	229, 234	4ti-0599	231, 234	4ti-0750/24/P	177
4ti-0546	229, 234	4ti-0599S	231, 234	4ti-0750/24/R	177
4ti-0547	229, 234	4ti-0640	239	4ti-0750/24/Y	177
4ti-0548	218, 234	4ti-0641	239	4ti-0750/32/B	177
4ti-0549	218, 234	4ti-0642	239	4ti-0750/32/G	177
4ti-0550	259, 270	4TI-0656	133	4ti-0750/32/P	177
4ti-0560	123, 126, 127, 131, 132, 258, 269, 270	4ti-0665	243	4ti-0750/32/R	177
4TI-0560	131, 132, 173	4ti-0680	105	4ti-0750/32/Y	177
4ti-0561	258, 270	4ti-0680-1	105	4ti-0750/48/B	177
4ti-0561S	258	4ti-0681	105	4ti-0750/48/G	177
4ti-0563	269	4ti-0683	105	4ti-0750/48/P	177
4ti-0565	128, 133, 134, 135, 257, 270	4ti-0684	105	4ti-0750/48/R	177
4TI-0565	129, 131	4ti-0685	105	4ti-0750/48/Y	177
4ti-0566	262, 263, 270	4ti-0686	105	4ti-0751	165, 275, 276
4ti-0573	217, 234	4ti-0688	105	4ti-0752	275
4ti-0573S	217, 234	4ti-0689	105	4ti-0753	155, 165, 166, 188, 190, 267
4ti-0574	217, 234	4ti-0710	123, 139, 188, 190	4ti-0754	165
4ti-0574S	217, 234	4ti-0711	139	4ti-0755	276
4ti-0575	217, 234	4ti-0720	140, 153, 188, 190	4ti-0757	166
4ti-0580	219, 234	4ti-0721	140	4ti-0760	172, 188, 190
4ti-0580S	219, 234	4ti-0730	134, 135, 188, 190	4ti-0761	172
4ti-0581	219, 234	4ti-0735	174, 188, 190	4ti-0770	119, 137, 188, 190
4ti-0582	219, 234	4ti-0736	174	4ti-0771	119, 137
4ti-0582S	219, 234	4ti-0740	171, 188, 190	4ti-0772	119, 137
4ti-0585	223, 234	4ti-0741	171	4ti-0775	159
4ti-0585S	223, 234	4ti-0750	175, 177, 185, 186, 188, 190	4ti-0778	280
4ti-0586	223, 234	4ti-0750/8/B	177	4ti-0780	178
		4ti-0750/8/G	177	4ti-0781	178, 188, 190, 275

## Part Number Index

Part No.	Page	Part No.	Page	Part No.	Page
4ti-0782	178, 275	4ti-1001	145	46-6002-4	92
4ti-0783	178, 275	4ti-1200	145, 155, 188, 190	46-6002-5	92
4ti-0784	178	4ti-1201	145	46-6002-6	92
4ti-0785	158, 188, 190	4ti-1300	146, 188, 190	46-6002-7	92
4ti-0786	159, 188, 190	4ti-1381	170, 188, 190	46-6002-8	92
4ti-0788	275	4ti-1384	169, 188, 190	46-6002-9	92
4ti-0789	159	4ti-1385	169	46-6002-10	92
4ti-0790	181	4ti-1387	169	46-6002-11	92
4ti-0790/2D	181	4ti-1400	146, 155, 188, 190	46-6002-12	92
4ti-0792	179, 188, 190	4ti-05231	221, 234	46-6002-13	92
4ti-0793	179, 188, 190	4ti-05381	155, 226, 227, 234	46-6002-14	92
4ti-0794	179, 188, 190	4ti-05481	218, 234	46-6002-15	92
4ti-0795	181	4ti-LB0109	198	46-6002-16	92
4ti-0796	180, 188, 190	4ti-LB0125	197	46-6002-17	92
4ti-0900	138, 188, 190	4ti-LB0147	194	46-6002-18	92
4ti-0901	138	4ti-LB0384/RIG	125	46-6501	95
4ti-0910	133	4ti-LB0770	136, 137	46-6502	95
4TI-0910/C	133	4ti-LB0960	128, 129	46-6511	95
4ti-0911	133	4ti-OX730	135	46-6512	95
4ti-0912	133	4ti-OX770C/SBC	136, 137	46-6513	95
4ti-0950	131, 188, 190	4ti-OX960	128, 129	46-6521	95
4TI-0950/C	131	6.09.661	98	46-6601	95
4ti-0950W-F	166	6.09.663	98	46-6602	95
4ti-0951	131	6.09.664	98	46-6604	95
4TI-0951	131	10-5010	101	46-6605	95
4ti-0952	131	10-5020	101	46-6606	95
4ti-0953	131	20-2101-A	81	46-8010	97
4ti-0954	132, 188, 190	20-4013	85	46-8011	97
4TI-0954	132	20-4016	86	46-8012	97
4ti-0955	173, 188, 190	20-4018	84, 85	46-8014	97
4TI-0955	173	42-1001	98	46-8112	97
4ti-0960	128, 129, 149, 152, 155, 188, 190, 227	42-1003	98	46-9001	93
4TI-0960	129	46-2004-115V	98	46-9008	93
4ti-0961	129	46-2004-230V	98	46-9012	93
4ti-0966	129	46-6001	92	48-9013-01	93
4ti-0970	130, 150, 152	46-6002-1	92	48-9013-02	93
4ti-0975	152	46-6002-2	92	59-1000	155, 244
4ti-1000	145, 188, 190	46-6002-3	92	59-1001	244

## Part Number Index

Part No.	Page	Part No.	Page	Part No.	Page
59-1002	244	65-7667	32	66-9455	35
59-1003	244	65-9303	23, 35	66-9951	67
59-1004	244	65-9451	32, 33	66-32033	60
59-2000	154, 155, 247	65-9460	34	66-32033-Y6	60
59-2001	155, 247	65-9801	67	66-32034	60
59-2002	247	65-54000	101	66-32034-L	60
59-2003	247	65-54001	101	66-32034-Y6	60
59-2004	247	65-54004	101	66-32034-Y6-L	60
59-2005	154, 155, 247	65-73000	66	66-32040	60
59-2006	247	65-73001	66	66-32040-Y6	60
59-2007	247	65-73002	66	66-32041	60
59-2008	247	65-73003	66	66-32041-Y6	60
59-2009	247	65-73004	66	66-32041-Y6-L	60
65-7514	23, 34	65-74000	66	66-32042	60
65-7515	23, 34	66-0196-01	15, 47	66-32042-L	60
65-7516	23, 34	66-0196-02	15	66-32043	60
65-7517	23, 34	66-0196-03	15	66-32043-L	60
65-7572	64	66-0700-00	59	66-32043-Y6	60
65-7573	64	66-0700-01	59	66-32043-Y6-L	60
65-7574	64	66-0700-02	59	66-32062	60
65-7575	64	66-0700-10	59	66-32062-Y6	60
65-7576	64	66-0700-11	59	66-32141	60
65-7577	64	66-0700-12	59	66-51003	60
65-7640	23, 33	66-1000-00	59	66-51004	29, 59, 60
65-7641	23, 33	66-1000-01	59	66-51014	60
65-7642	23, 33	66-1000-02	59	66-51016	47, 59, 60
65-7643	23, 33	66-1000-10	59	66-51017	60
65-7644	33	66-1000-11	59	66-51020	31
65-7645	33	66-1000-12	59	66-51021	30
65-7646	33	66-1001	233	66-51022	37
65-7647	33	66-1021	233	66-51023	38
65-7660	23, 32	66-1800	15, 33	66-51025	36
65-7661	23, 32	66-1801	15, 32	66-51026	29, 46, 59
65-7662	23, 32	66-1802	15	66-61002	44, 47, 59, 60
65-7663	23, 32	66-1803	15	66-61003	45, 60
65-7664	32	66-9302	23, 35	66-62318	23, 44
65-7665	32	66-9401	35, 54, 65, 67	66-62318-Y6	23, 44
65-7666	32	66-9402	54, 65	66-62319	23, 44

## Part Number Index

<b>Part No.</b>	<b>Page</b>	<b>Part No.</b>	<b>Page</b>	<b>Part No.</b>	<b>Page</b>
66-62319-Y6 .....	23, 44	67-0757-11 .....	23, 38	68-1003-00 .....	23, 31
66-62325 .....	23, 43	67-63111-10 .....	67	68-1003-01 .....	23, 30, 31
66-62325-Y6 .....	23, 43	67-63111-50 .....	67	68-1003-10 .....	23, 31
66-62326 .....	23, 43	68-0300-20 .....	42	68-1003-11 .....	23, 31
66-62326-Y6 .....	23, 43	68-0301-00 .....	23	68-1004-00 .....	31
66-62330 .....	23, 45	68-0301-01 .....	23	68-1004-01 .....	31
66-62330-Y6 .....	23, 45	68-0301-10 .....	23	68-1004-10 .....	31
66-62345 .....	23, 45	68-0301-11 .....	23	68-1004-11 .....	31
66-62345-Y6 .....	23, 45	68-0303-00 .....	23, 42	68-4000-00 .....	23, 54
66-63100-Y1 .....	65	68-0303-01 .....	23, 42	68-4000-22 .....	54
66-63100-Y2 .....	65	68-0303-10 .....	23, 42	68-4000-31 .....	23, 54
66-63100-Y3 .....	65	68-0303-11 .....	23, 42	68-4000-33 .....	54
66-63100-Y4 .....	65	68-0701-00 .....	23, 46	68-53100-Z1N .....	64
66-63100-Y5 .....	65	68-0701-02 .....	23, 46	68-53100-Z2N .....	64
66-63100-Y6 .....	65	68-0701-10 .....	23, 46	68-53100-Z3N .....	64
66-63100-Y8 .....	65	68-0701-11 .....	46	68-53100-Z4N .....	64
66-63100-Y10 .....	65	68-0701-12 .....	23	68-53100-Z5N .....	64
66-63100-Y11 .....	65	68-0703-00 .....	23, 29	68-53100-Z6N .....	64
66-63100-Y12 .....	65	68-0703-02 .....	23, 29, 72	68-53100-Z8N .....	64
66-63100-Y13 .....	65	68-0703-10 .....	23, 29	68-53100-Z10N .....	64
67-0200-00 .....	55	68-0703-11 .....	29	68-53100-Z11N .....	64
67-0203-00 .....	55	68-0703-12 .....	23, 29	68-53100-Z12N .....	64
67-0203-01 .....	23, 55	68-0704-00 .....	29	68-53100-Z13N .....	64
67-0203-02 .....	23, 55	68-0704-02 .....	29	68-53111-10N .....	64, 67
67-0203-10 .....	23, 55	68-0704-10 .....	29	68-53111-10X .....	67
67-0203-11 .....	23, 55	68-0704-12 .....	29	68-53111-50N .....	64, 67
67-0203-51 .....	55	68-0801-00 .....	23, 30	68-53111-50X .....	67
67-0753-00 .....	23, 36	68-0801-01 .....	23, 30	69-0200-11 .....	23
67-0753-02 .....	23, 36	68-0801-10 .....	23, 30	70-2010 .....	, 81
67-0753-10 .....	23, 36	68-0801-11 .....	23, 30	70-4012 .....	84, 85
67-0753-12 .....	23, 36	68-0802-00 .....	30	70-4013 .....	86
67-0755-00 .....	23, 37	68-0802-01 .....	30	75-0001 .....	103
67-0755-01 .....	23, 37	68-0802-10 .....	30	75-0101 .....	103
67-0755-10 .....	23, 37	68-0802-11 .....	30	75-1001-A .....	103
67-0755-11 .....	23, 37	68-1001-00 .....	23, 47	75-1001-B .....	103
67-0757-00 .....	23, 38	68-1001-01 .....	23, 47	75-1001-C .....	103
67-0757-01 .....	23, 38	68-1001-10 .....	23, 47	75-1001-D .....	103
67-0757-10 .....	23, 38	68-1001-11 .....	23, 47	75-1001-E .....	103

## Part Number Index

Part No.	Page	Part No.	Page	Part No.	Page
75-1001-F	103	BCS-112	314	BCS-130	301, 302
75-1001-G	103	BCS-113	314	BCS-131	301
75-1001-H	103	BCS-113B	314	BCS-132	301
75-1001-I	103	BCS-113GR	314	BCS-133	302
75-1001-J	103	BCS-113OR	314	BCS-137	298, 306
75-1013	103	BCS-113PK	314	BCS-138	298, 302, 306
75-9001	103	BCS-113PL	314	BCS-143	316
75-9900	103	BCS-114	314	BCS-149	298, 307
77-0006	103	BCS-115	314	BCS-153	299, 308
96-0001	106	BCS-115-25B	314	BCS-154	299, 308
96-0002	106	BCS-115-25G	314	BCS-155	299, 308
96-0003	106	BCS-115-25GR	314	BCS-156	299, 308
96-0004	106	BCS-115-25OR	314	BCS-157	299, 308
97-0001	106	BCS-115-25PK	314	BCS-163	298, 306
98-0001	106	BCS-115-25PL	314	BCS-164	306
98-0002	106	BCS-115-25R	314	BCS-165	306
98-0003	106	BCS-115B	314	BCS-166	302
98-0004	106	BCS-115GR	314	BCS-170	292
243354-001	110	BCS-115OR	314	BCS-170G	292
252885	110	BCS-115PK	314	BCS-1700	292
252886	110	BCS-115PL	314	BCS-170PK	292
252888-001	110	BCS-115R	314	BCS-172	292
252888-002	110	BCS-116	306	BCS-172CS	293
252888-003	110	BCS-117B	314	BCS-184	311
252888-004	110	BCS-117GR	314	BCS-205	316
252888-005	110	BCS-117OR	314	BCS-206	315
BCS-102	306	BCS-117PK	314	BCS-206B	315
BCS-104	312	BCS-117PL	314	BCS-206G	315
BCS-105	298, 306	BCS-118B	314	BCS-206MC	315
BCS-108	298, 306	BCS-118GR	314	BCS-206O	315
BCS-108G	306	BCS-118PL	314	BCS-206P	315
BCS-108O	306	BCS-123	312	BCS-206PK	315
BCS-111	314	BCS-125	298, 306	BCS-207	315
BCS-111B	314	BCS-125G	306	BCS-207B	315
BCS-111GR	314	BCS-125O	306	BCS-207G	315
BCS-111OR	314	BCS-126	298, 306	BCS-207O	315
BCS-111PK	314	BCS-127	298, 306	BCS-207P	315
BCS-111PL	314	BCS-128	298, 306	BCS-207PK	315

## Part Number Index

Part No.	Page	Part No.	Page	Part No.	Page
BCS-209G	315	BCS-4070	291	BCS-570	302
BCS-209P	315	BCS-407P	291	BCS-572	302
BCS-210	293	BCS-502	300, 302	BCS-573	302
BCS-211	314	BCS-502-C	301	BCS-575	302
BCS-211B	314	BCS-502-CG	301	BCS-576	302
BCS-211GR	314	BCS-502-CO	301	BCS-2430	317
BCS-211OR	314	BCS-502-CPK	301	BCS-2431	317
BCS-211PK	314	BCS-502-F	300	BCS-2432	317
BCS-211PL	314	BCS-502G	300	BCS-2433	317
BCS-212	314	BCS-502O	300	BCS-2434	317
BCS-213MC	316	BCS-502PK	300	BCS-2435	317
BCS-215G	315	BCS-503	300, 302	BCS-2436	317
BCS-215P	315	BCS-503-C	301	BCS-2437	317
BCS-217G	315	BCS-503-CG	301	BCS-2438	317
BCS-217P	315	BCS-503-CO	301	BCS-2501	317
BCS-219G	315	BCS-503-CPK	301	BCS-2502	317
BCS-219P	315	BCS-503-F	300	BCS-2503	317
BCS-220G	315	BCS-503G	300	BCS-2504	317
BCS-220P	315	BCS-503O	300	BCS-2505	317
BCS-221G	315	BCS-503PK	300	BCS-2510	317
BCS-221P	315	BCS-504	300, 302	BCS-2511	317
BCS-222	316	BCS-511	300, 301	BCS-2512	317
BCS-231	298, 307	BCS-512	301	BCS-2513	317
BCS-232	299, 308	BCS-513	300	BCS-2514	317
BCS-235	299, 308	BCS-523	298, 302, 307	BCS-2515	317
BCS-252	312	BCS-529	298, 302, 307	BCS-2516	317
BCS-262	292	BCS-532	299, 308	BCS-2517	317
BCS-262CS	293	BCS-533	299, 308	BCS-3105	293
BCS-265	298, 307	BCS-534	298, 302, 306	BCS-3106	293
BCS-266	298, 307	BCS-535	298, 302, 306	BCS-3107	293
BCS-405	291	BCS-536	311	FLX-20-1003	79
BCS-405G	291	BCS-537	311	XP-A	251
BCS-405MC	291	BCS-538	298, 307	XP-A_100V	251
BCS-405O	291	BCS-539	298, 306	XP-A_230V	251
BCS-405PK	291	BCS-556	302	X-Tape_2000	251
BCS-406	292	BCS-557	302		

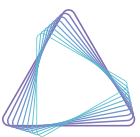

**AZENTA**  
LIFE SCIENCES



### License Statement and Trademarks

Disclaimer: FrameStar®, FreezerPro®, IntelliXcap™, SampleStore™, BioStore™, Strata™ and Tube Auditor are trademarks of Azenta US, Inc. Azenta US, Inc. recognizes that designated trademarks and brands are the property of their respective owners.



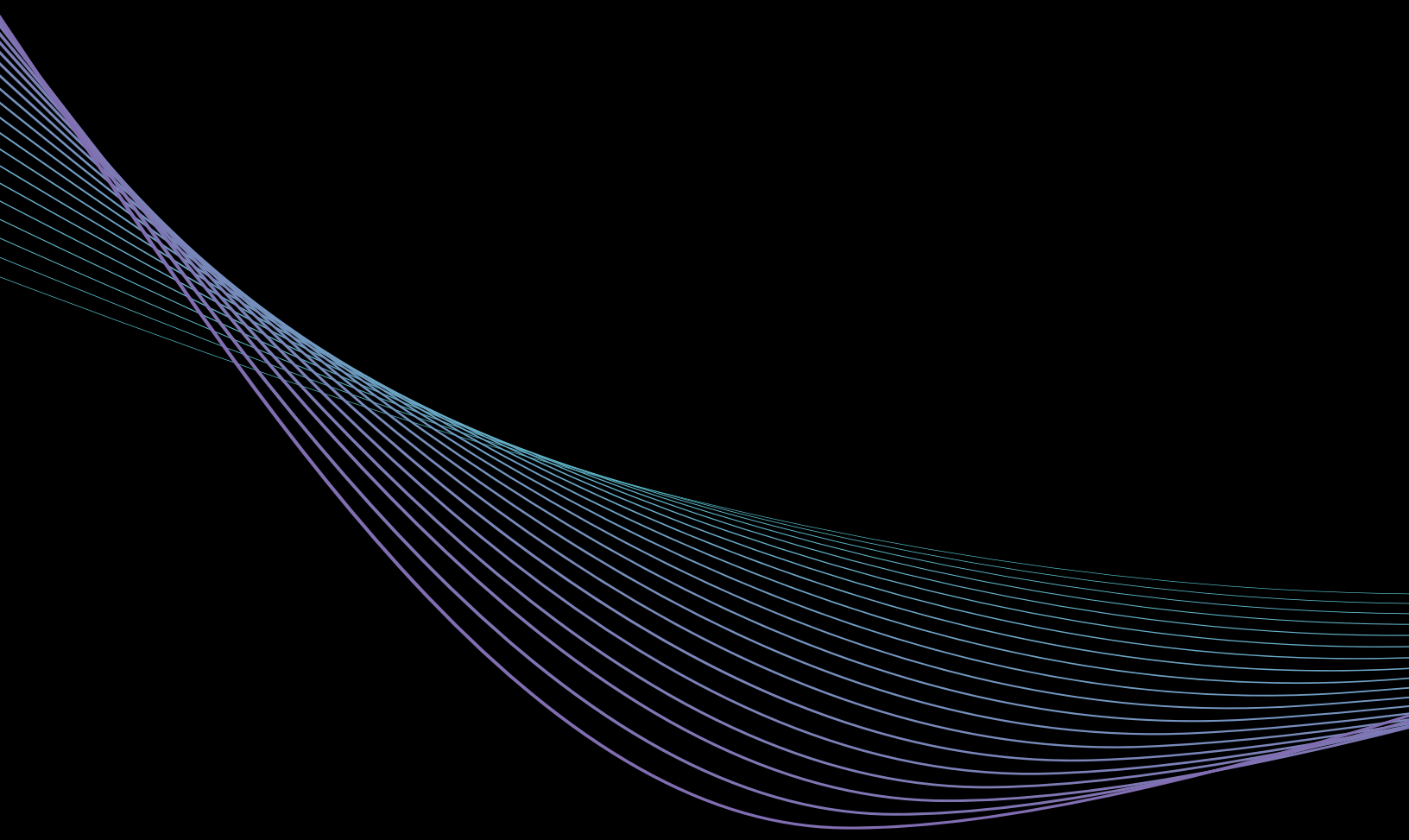

**AZENTA**  
LIFE SCIENCES

© 2022 Azenta US, Inc. All rights reserved.  
All trademarks are property of Azenta US, Inc. unless otherwise specified.

[azenta.com](https://azenta.com)

Azenta Life Sciences® 40001-CAT 1221