

Alcohol-Free Cell Freezing Containers

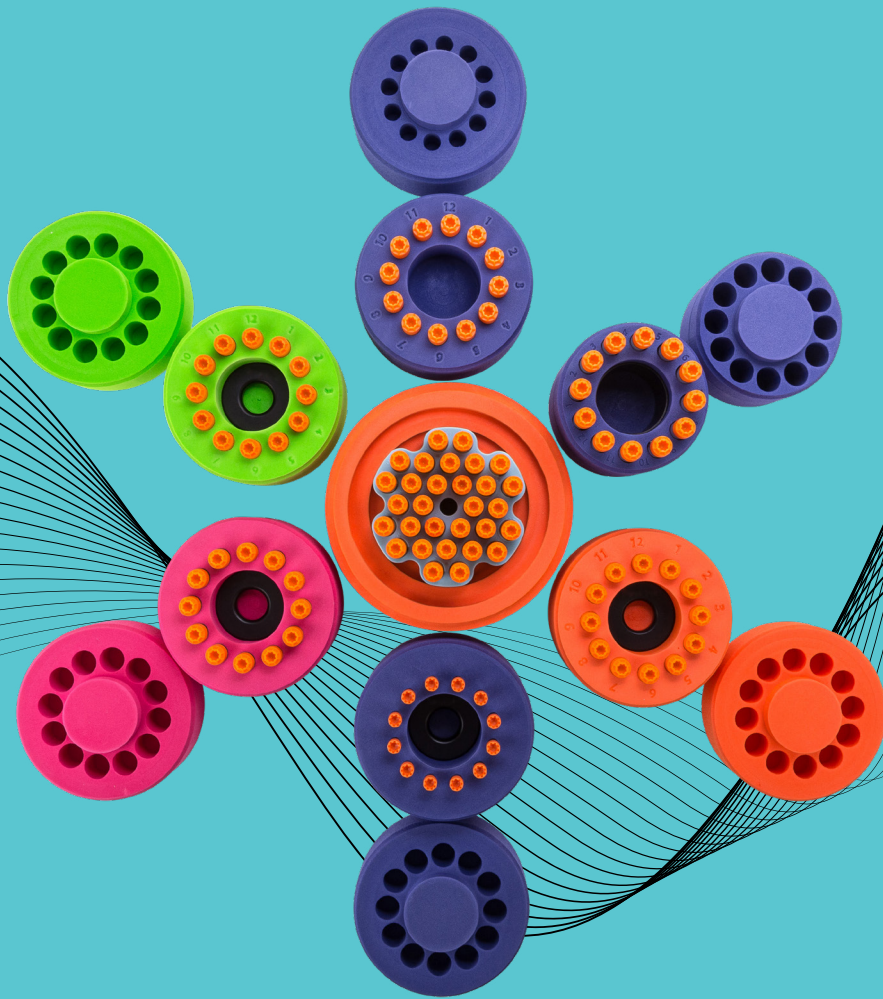

Alcohol-Free Cell Freezing Containers



Alcohol-free cell freezing containers ensure standardized controlled-rate $-1^{\circ}\text{C}/\text{minute}$ cell freezing in a -80°C freezer - without alcohol or any fluids. Proven for use with a variety of cell types including stem cells, primary cells, PBMC cell lines, insect cells, yeast cells, and others. The Alcohol-Free Cell Freezing technology utilizes a thermo-conductive alloy core and highly-insulative outer material to control the rate of heat removal and provide reproducible cell cryopreservation. Alcohol-Free Cell Freezing units are easy to use and deliver comparable results to expensive programmable freezers.

Alcohol-free cell freezing containers are proven to work with many cell types including:

Stem Cells

- Human Embryonic Stem
- Preadipocytes
- Breast Cancer Stem
- Colon Cancer Stem
- Glioblastoma Stem
- Mouse Embryonic Stem
- Human Endothelial
- Progenitor

Primary Cells

- Neonatal Keratinocytes
- Human WBCs
- Mouse
- WBCs
- Human CD34+
- Muscle
- Human Tendon
- Fibroblasts
- Melanoma Tumor
- Human Cardiac
- Ventricular
- Human Cardiac Atrial

Cell Lines

- CHO
- LnCap
- HTB77
- A549
- HeLa

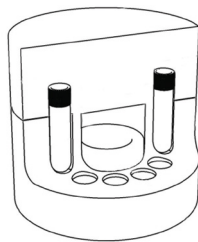

Cell Freezing Containers, in combination with a -80°C freezer, will provide the freezing rate of $-1^{\circ}\text{C}/\text{minute}$ that is ideal for cryopreservation of most cells and cell lines. Using a combination of uniform-density cross-linked polyethylene foam, a solid state core, and radial vial symmetry, freezing profiles are consistent and reproducible. It is important to fully load Cell Freezing Containers prior to freezing. Foam is non-absorbent and will impose negligible change in the freezer environment; thereby protecting nearby frozen samples. The low heat content also ensures that Cell Freezing Containers will rapidly return to room temperature when removed from the freezer.

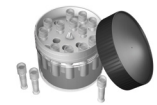

Alcohol-free cell freezing containers	Isopropanol (IPA) Container
No alcohol <ul style="list-style-type: none"> • No fluids • No pre-cooling • Saves 12L/unit of IPA per year 	Requires isopropanol <ul style="list-style-type: none"> • Replace alcohol every 5 uses • Track number of uses • Pre-cool alcohol in refrigerator
No variability <ul style="list-style-type: none"> • All vials have uniform freeze rate • Radially symmetric design ensures vial consistency 	Inconsistent freeze rate <ul style="list-style-type: none"> • Alcohol degradation induces variability • Two circles of wells; two freeze rates
No on-going cost <ul style="list-style-type: none"> • No alcohol purchase or disposal 	Approximately \$350/year <ul style="list-style-type: none"> • Change alcohol weekly • Dispose of hazardous waste
No stuck lids <ul style="list-style-type: none"> • Ergonomic lid comes off easily when frozen • Not cold to the touch when removing from the -80°C freezer 	Difficult to handle and open <ul style="list-style-type: none"> • Screw cap difficult to remove when frozen • Frozen unit is slippery and cold to touch
Quick re-use time <ul style="list-style-type: none"> • Ready to use again after five minutes 	Wait between runs <ul style="list-style-type: none"> • Takes >1 hr for alcohol to warm-up

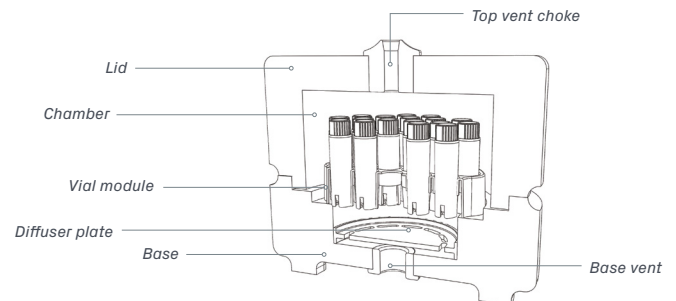

Cell Freezing Containers for 30 x 1mL or 2mL Cryo Tubes utilize a solid state core and controlled micro-convection technology to evenly draw in -80°C freezer air through a bottom base vent, uniformly disperse the cold air around each vial in the central chamber and then release the thermal load from the vials through a top vent choke. The inner vial module holds 30 cryogenic vials and can be removed in one step. Each vial achieves a uniform and reproducible $-1^{\circ}\text{C}/\text{minute}$ freezing profile and thermal profiles are highly reproducible. Due to the low thermal mass of the uniform-density cross-linked polyethylene foam container, freezing can be conducted without a rise in local freezer temperature, thereby protecting nearby samples.



Alcohol-Free Cell Freezing Containers

Alcohol-Free Cell Freezing Container Reproducibility

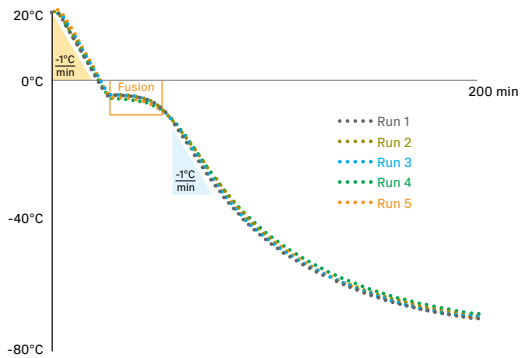

Performance test: A temperature probe was placed into a 2.0 mL cryogenic vial containing 1.0 mL of water and the tube was inserted into a room temperature Alcohol-Free Cell Freezing Container. The container was placed into a -80°C freezer and the temperature rate and profile was recorded over a 3 hour period. The test was repeated 5 consecutive times. **Conclusion:** The Alcohol-Free Cell Freezing Container generated identical fusion time and cooling profiles over five consecutive freeze cycles.

Alcohol-Free Cell Freezing Container Protocols

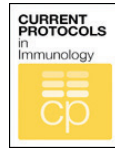

Cryopreservation and Thawing of Cells

Wayne M. Yokoyama, Maria L. Thompson, Rolf O. Ehrhardt
University of California School of Medicine, San Francisco, CA BioCision LLC, Larkspur, California
Curr. Protoc. Immunology. 2012 Nov; 99 Appendix 3G

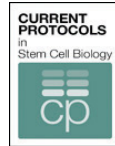

Standardized Cryopreservation of Pluripotent Stem Cells

Rick I. Cohen, Maria L. Thompson, Brian Schryver, Rolf O. Ehrhardt
Rutgers University, Piscataway, New Jersey
BioCision LLC, San Rafael, California
Curr. Protoc. Stem Cell Biol. 28:1C.14.1-1C.14.10

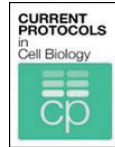

Standardized Cryopreservation of Human Primary Cells

Thomas V. Ramos, Aby J. Mathew, Maria L. Thompson, Rolf O. Ehrhardt
HemaCare Corporation, Van Nuys, California, BioLife Solutions, Bothell, Washington, BioCision, Larkspur, California
Curr. Protoc. Cell Biology. 2014 Sept; 64 Appendix 3I.

Alcohol-Free Cell Freezing Container Performance vs. IPA Container

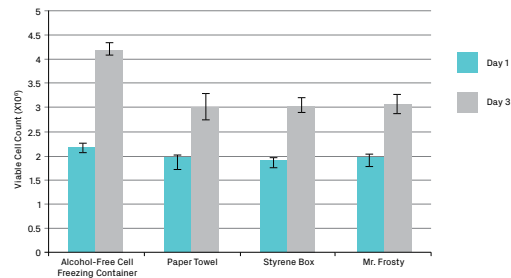

Human embryonic stem cells, RC-10 were frozen using the technique indicated, thawed after 2 weeks in LN₂, and counted immediately (Day 1) or after 3 days of growth (Day 3).

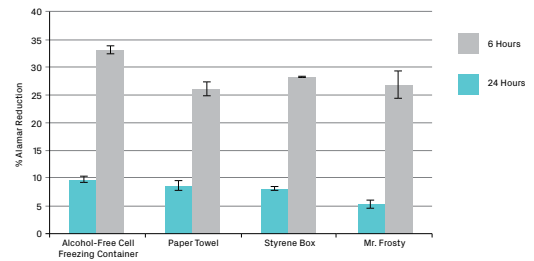

Alamar blue reduction assay for proliferation assessment showed cells frozen in an Alcohol-Free Cell Freezing Container grew more quickly, leading to more total cells.

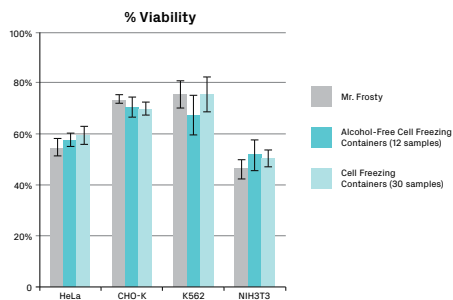

HeLa, CHO-K, K562, NIH3T3. 12-well Alcohol-Free 30-well Cell Freezing Containers, Cell Freezing Containers or “Mr. Frosty” freezing containers were used to freeze all four cell lines. Identical transfection efficiencies and viabilities were observed after thawing.

Growth Performance 24 hours Post-thaw

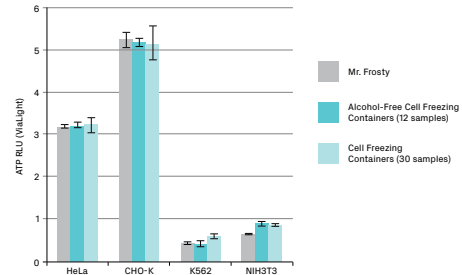

Identical growth of cells was observed 24 hours post-thaw.

Alcohol-Free Cell Freezing Containers

Alcohol-Free Cell Freezing Container Performance vs. Programmable Freezer

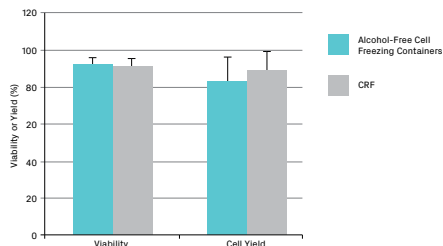

Ag-Tregs. Effects of freezing on antigen-specific Treg (Ag-Treg) cell therapy products; Ag-Tregs (n = 6) were frozen at concentration of 1 to 10 x 10⁶ cells/mL using the Alcohol-Free Cell freezing Container or controlled-rate freezer (CRF) with a freezing rate of -1°C/min. Viability and absolute viable cell count of thawed Ag-Treg cell therapy products were evaluated by flow cytometry. - Data generated by TxCell SA

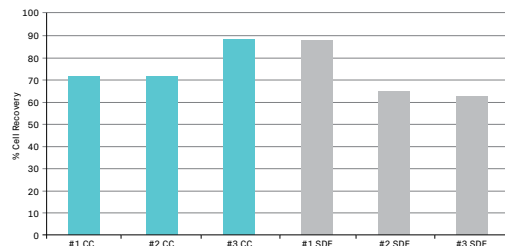

Comparison of freezing methods. Graph comparing % of cell recovery after freezing with the Alcohol-Free Cell Freezing Container (blue) versus freezing using a programmable step-down freezer (gray) in 3 different samples at high cell concentration. There was no significant difference between the two freezing methods. - Data performed by UCSF Diabetes Center

For 1.0 mL or 2.0 mL Cryogenic Vials



Cell Freezing Containers for 12 x 1mL 96-format Sample Tubes

For 12 standard 1mL storage tubes. 0.5mL to 1mL fill per vial. Optimized for freezing 1mL 96-format sample tubes. Radially symmetric for uniform freezing. Numbered wells for easy identification. Beveled lid for secure gripping and easy opening.



Cell Freezing Containers for 12 x 1mL or 2mL Cryo Tubes

For 12 standard 1.0 mL to 2.0 mL cryogenic vials, 1.0 mL fill per vial. Radially symmetric for uniform vial freezing. Numbered wells for easy sample identification. Beveled lid for secure gripping and easy opening. Exposed vial tops when lid is open for quick, organized removal of frozen samples.

Ordering Information

BCS-407P	Cell Freezing Container, for 12 x 1ml 96-format sample tubes, purple
BCS-407O	Cell Freezing Container, for 12 x 1ml 96-format sample tubes, orange

Ordering Information

BCS-405	Cell Freezing Container, for 12 x 1ml or 2ml cryo tubes, purple
BCS-405G	Cell Freezing Container, for 12 x 1ml or 2ml cryo tubes, green
BCS-405O	Cell Freezing Container, for 12 x 1ml or 2ml cryo tubes, orange
BCS-405PK	Cell Freezing Container, for 12 x 1ml or 2ml cryo tubes, pink
BCS-405MC	Cell Freezing Container, for 12 x 1ml or 2ml cryo tubes, multipack with 4 colors - purple, green, orange and pink



Alcohol-Free Cell Freezing Containers

For 3.5 mL to 5.0 mL Cryogenic Vials



Cell Freezing Containers for 12 x 3.5mL to 5mL Cryo Tubes

For 12 standard 3.5 mL to 5.0 mL fill cryogenic vials, 3.5 to 5.0 mL fill per vial. Radially symmetric for uniform vial freezing. Numbered wells for easy sample identification. Beveled lid for secure gripping and easy opening. Exposed vial tops when lid is open for quick, organized removal of frozen samples.

Ordering Information

BCS-406	Cell Freezing Container, for 12 x 3.5ml to 5ml cryo tubes, purple
----------------	--



Cell Freezing Containers for 30 x 1mL or 2mL Cryo Tubes

For 30 standard 1.0 mL to 2.0 mL cryogenic vials, 1.0 mL fill per vial. Controlled micro-convection for uniform freezing of 30 vials. Removable vial tray for one-step transfer of samples into and out of freezing chamber.

Ordering Information

BCS-170	Cell Freezing Container, for 30 x 1ml or 2ml cryo tubes, purple
BCS-170G	Cell Freezing Container, for 30 x 1ml or 2ml cryo tubes, green
BCS-170O	Cell Freezing Container, for 30 x 1ml or 2ml cryo tubes, orange
BCS-170PK	Cell Freezing Container, for 30 x 1ml or 2ml cryo tubes, pink

For Injectable Cell Therapy Ampules

Cell Freezing Containers for 12 x 2mL Injectable Cell Therapy Ampules and Cell Freezing Containers for 6 x 10mL Injectable Cell Therapy Ampules

For 12 standard 2.0 mL injectable ampules, 1.0 mL fill per ampule (Cell Freezing Containers for 12 x 2mL Injectable Cell Therapy Ampules). For 6 standard 10.0 mL injectable ampules, 5.0 mL fill per ampule (Cell Freezing Containers for 6 x 10mL Injectable Cell Therapy Ampules). Radially symmetric for uniform freezing of injectable ampules. Easy open lid. Exposed vial tops when lid is open for quick, organized removal of frozen samples.



Ordering Information

BCS-172	Cell Freezing Container, for 12 x 2ml injectable cell therapy ampules, purple
BCS-262	Cell Freezing Container, for 6 x 10ml injectable cell therapy ampules, purple

Cell Cryopreservation Systems



Cell Freezing Containers for 12 x 2mL Injectable Cell Therapy Ampules Stem Cell Cryopreservation System

Ordering Information

BCS-172CS	Stem Cell Cryopreservation System , containing 1 x Cell Freezing Container, for 12 x 2ml injectable cell therapy ampules, purple and 1 x Thermoconductive Tube Rack, holds 12 x 2ml injectable cell therapy ampules, cylindrical wells, gray
------------------	--



Cell Freezing Containers for 6 x 10mL Injectable Cell Therapy Ampules Stem Cell Cryopreservation System

Ordering Information

BCS-262CS	Stem Cell Cryopreservation System , containing 1 x Cell Freezing Container, for 6 x 10ml injectable cell therapy ampules, purple and 1 x Thermoconductive Tube Rack, holds 12 x 10ml injectable cell therapy ampules, cylindrical wells, gray
------------------	---



Note: For optimal freezing it is important to fully load each Cell Freezing Container prior to freezing. Cell Freezing Container Filler Vials are recommended for filling any empty wells.

Cell Freezing Container Filler Vials

To ensure cell freezing rate consistency and uniform results when using Azenta containers, insert a Cell Freezing Container Filler Vial into empty wells when freezing less than a full load. Suitable for repeated use and compatible with Cell Freezing Containers for 12 x 1mL or 2mL Cryo Tubes, Cell Freezing Containers for 30 x 1mL or 2mL Cryo Tubes and Cell Freezing Containers for 12 x 3.5mL to 5mL Cryo Tubes containers. 6 per pack.

Ordering Information

BCS-3105	Cell Freezing Container Filler Vials , 6 x 2ml
BCS-3106	Cell Freezing Container Filler Vials , 6 x 5ml
BCS-3107	Cell Freezing Container Filler Vials , 6 x 1mL



Cell Freezing Container Vial Module for 30 x 1ml or 2ml Cryo Tubes

Cell Freezing Container Vial Module for 30 x 1ml or 2ml Cryo Tubes is a holder for 30 1.0 mL or 2.0 mL cryogenic vials that allows one-step insertion and removal of all 30 vials at once. Fits into a standard 5.0 x 5.0 x 2.0 inch cryostorage box. Compatible with dry ice and liquid nitrogen.

Ordering Information

BCS-210	Removable Cryo Tube Module for use with the Cell Freezing Container for 30 x 1mL or 2ml Cryo Tubes
----------------	---